

Panasonic

Digital Super Hybrid System User Manual

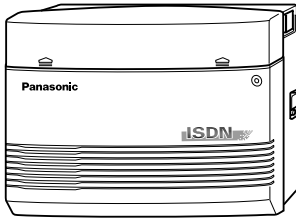

Model No. **KX-TD612CE**



Thank you for purchasing a Panasonic Digital Super Hybrid System, Model KX-TD612. Please read this manual before connecting the Digital Super Hybrid System and save this manual for future reference.

Version 3

Thank you for purchasing the Panasonic Digital Super Hybrid System.

Telephones

This system can connect digital Panasonic digital proprietary telephones. Single line devices such as a single line telephone, facsimile, cordless telephone, voice processing system, etc. can also be connected.

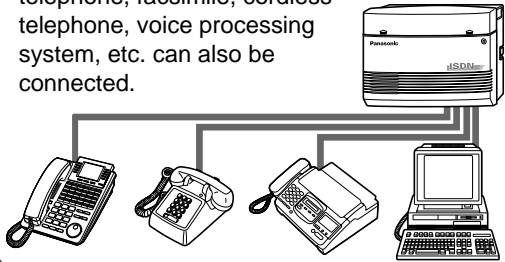

1.3.1 Connection Example

EXtra Device Port (XDP)

This system can double the extension capacity by connecting a digital proprietary telephone and a single line telephone. The digital proprietary telephone can share the extension with another single line telephone. Furthermore, you can connect a Panasonic digital proprietary telephone and a single line telephone to one jack and use them as individual extensions.

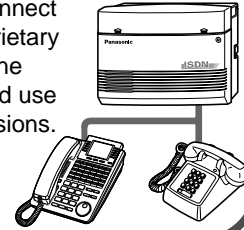

1.4.1 Adding Another Telephone in Parallel

**Saves on telephone charges
(Automatic Route Selection)**

This system chooses the most cost-effective carrier based on the outside number dialed and the time called.

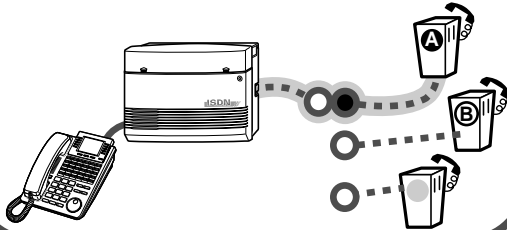

Page 33

**Call Record
(Station Message Detail Recording)**

This system can record or print out call information: date, time, extension no., dialled no., duration, etc.

Date	Time	Ext
24/06/00	10:03	123
24/06/00	11:07	223

Consult your dealer

**Automatic Selection
of CLIP/COLP**

This system provides you to let the calling/called party know your CO line number or the extension number assigned by the system programming.

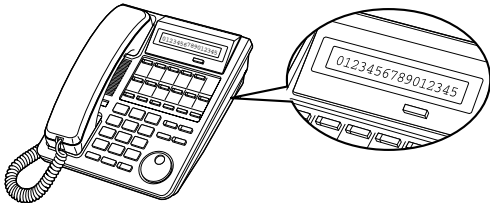

2.8.5 Automatic Selection of Calling/Connected Line Identification Presentation (CLIP/COLP)

Built-in Voice Message

You can forward incoming calls to your personal message box to let callers leave their voice message when you cannot answer the phone.

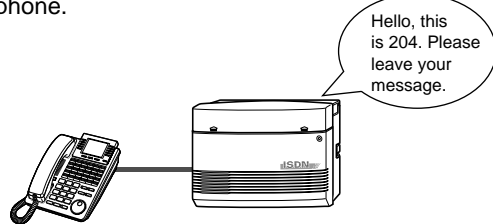

2.6.1 Built-in Voice Message

Note

- This product is designed to interwork with the:
 - pan-European Integrated Services Digital Network (ISDN) using ISDN basic access.
 - Public Switched Telephone Network (PSTN) of the EU member nations.
- In this manual, the two-letter suffix of each model number is omitted.
- The default setting or operation may vary depending on the area of use. In this case, the default setting or the operation for each area is listed.

Notice

- Depending on the model type of the public exchange, there is a possibility that pulse dialling sent by the PBX will not be correctly received by the public exchange.
- We, Kyushu Matsushita Electric Co., Ltd. of Matsushita Electric Industrial Co., Ltd./Panasonic Testing Centre (Europe) GmbH, declare that this equipment is in compliance with the essential requirements and other relevant provisions of Directive 1999/5/EC.
If you want to get a copy of the original Declaration of Conformity of our products which relates to the R&TTE, please contact to our web address:
<http://doc.panasonic-tc.de>

IMPORTANT

If there is something unclear in this manual, please consult your dealer.

Important Information

WARNING

THIS UNIT MAY ONLY BE INSTALLED AND SERVICED BY QUALIFIED SERVICE PERSONNEL. WHEN A FAILURE OCCURS WHICH RESULTS IN THE INTERNAL PARTS BECOMING ACCESSIBLE, DISCONNECT THE POWER SUPPLY CORD IMMEDIATELY AND RETURN THIS UNIT TO YOUR DEALER.

DISCONNECT THE TELECOM CONNECTION BEFORE DISCONNECTING THE POWER CONNECTION PRIOR TO RELOCATING THE EQUIPMENT, AND RECONNECT THE POWER FIRST.

THIS UNIT IS EQUIPPED WITH AN EARTHING CONTACT PLUG. FOR SAFETY REASONS THIS PLUG MUST ONLY BE CONNECTED TO AN EARTHING CONTACT SOCKET WHICH HAS BEEN INSTALLED ACCORDING TO REGULATIONS.

THE POWER SUPPLY CORD IS USED AS THE MAIN DISCONNECT DEVICE. ENSURE THAT THE SOCKET-OUTLET IS LOCATED/INSTALLED NEAR THE EQUIPMENT AND IS EASILY ACCESSIBLE.

TO PREVENT FIRE OR SHOCK HAZARD, DO NOT EXPOSE THIS PRODUCT TO RAIN OR MOISTURE.

WARNING

Static sensitive devices are used. To protect printed circuit boards from static electricity, do not touch connectors indicated to the right. To discharge body static, touch ground or wear a grounding strap.

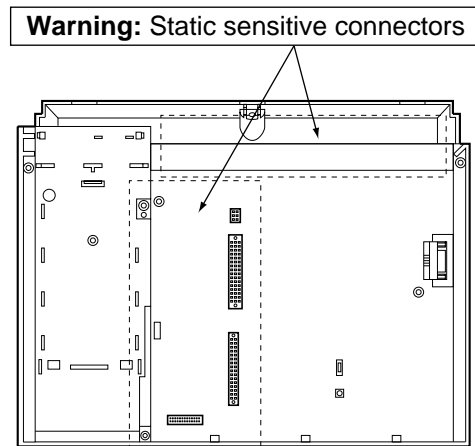

Safety Instructions

When using your telephone equipment, basic safety precautions should always be followed to reduce the risk of fire, electric shock and injury to persons, including the following:

1. Do not use this product near water, for example, near a bathtub, washbowl, kitchen sink or laundry tub, in a wet basement or near a swimming pool.
2. Avoid using a telephone (other than a cordless type) during an electric storm. There may be a remote risk of electric shock from lightning.
3. Do not use the telephone to report a gas leak in the vicinity of the leak.
4. Use only the power cord and batteries indicated in this manual. Do not dispose of batteries in a fire. They may explode. Check with local codes for possible special disposal instructions.

SAVE THESE INSTRUCTIONS

The following icons are used frequently in this manual.

**Notice**

- The Digital Proprietary Telephone is abbreviated as "DPT".
- The Single Line Telephone is abbreviated as "SLT".
- "Console" is a generic designation for Digital DSS Console (KX-T7240/KX-T7440) and Digital Attendant Console (KX-T7441).

Attention

- Keep the unit away from heating appliances and electrical noise generating devices such as fluorescent lamps, motors and televisions. These noise sources can interfere with the performance of the unit.
- This unit should be kept free of dust, moisture, high temperature (more than 40 °C) and vibration, and should not be exposed to direct sunlight.
- Never attempt to insert wires, pins, etc., into the vents or holes of this unit.
- If there is any trouble, disconnect the unit from the telephone line. If you have an ISDN line, plug an ISDN telephone directly into it; if you have an analogue CO line, plug a regular telephone directly into it. If the telephone operates properly, do not reconnect the unit to the line until the trouble has been repaired. If the telephone does not operate properly, chances are that the trouble is in the telephone system, and not in the unit.
- Do not use benzine, thinner, or any abrasive powder to clean the cabinet. Wipe it with a soft cloth.

The serial number of this product may be found on the label affixed to the unit. You should note the model number and the serial number of this unit in the space provided and retain this manual as a permanent record of your purchase, to aid in identification in the event of theft.

MODEL NO.: _____

SERIAL NO.: _____

For your future reference

DATE OF PURCHASE _____

NAME OF DEALER _____

DEALER'S ADDRESS _____

DEALER'S TEL. NO. _____

Table of Contents

1 Overview

1.1 Capacity	12
1.1.1 Capacity	12
1.2 Names and Locations	13
1.2.1 Names and Locations	13
1.3 Connection Example	16
1.3.1 Connection Example	16
1.4 Adding Another Telephone in Parallel (EXtra Device Port [XDP])	17
1.4.1 Adding Another Telephone in Parallel	17
1.5 Restarting the System	19
1.5.1 Restarting the System	19

2 Operation

2.1 Before Operating the Telephones	22
2.1.1 Before Operating the Telephones	22
2.1.2 LCD Language Change	28
2.1.3 For ISDN Extension Users	30
2.2 Making Calls	31
2.2.1 Basic Calling	31
2.2.2 Easy Dialling	34
2.2.3 Redial	40
2.2.4 When the Dialed Line is Busy or There is No Answer.....	42
2.2.5 Calling without Restrictions	49
2.2.6 Changing the Mode	51
2.2.7 Integrated Services Digital Network (ISDN) Service Access.....	53
2.2.8 To Access Another Party Directly from Outside (Direct Inward System Access [DISA])	55
2.3 Receiving Calls	62
2.3.1 Answering Calls	62
2.3.2 Answering Hands-free (Hands-free Answerback)	64
2.3.3 Answering a Call Ringing at Another Telephone (Call Pickup)	65
2.3.4 Answering a Call via an External Speaker (Trunk Answer From Any Station [TAFAS])	67
2.3.5 Deflecting a Call (Call Deflection)	69
2.4 During a Conversation	71
2.4.1 Call Duration	71
2.4.2 Holding a Call.....	72
2.4.3 Retrieving a Call on a Telephone Answering Machine (TAM)	79
2.4.4 Terminal Portability (TP) for ISDN Extension	80
2.4.5 Talking to Two Parties Alternately (Call Splitting)	81
2.4.6 Transferring a Call.....	82
2.4.7 Answering a Call Waiting	85
2.4.8 Three-party Conversation.....	87
2.4.9 Saving a Number (Notebook Function).....	89

2.4.10	Mute	90
2.4.11	Letting Other People Listen to the Conversation (Off-Hook Monitor)	91
2.5	Using ISDN Additional Services	92
2.5.1	Transferring a Call from ISDN Line to ISDN Line (ISDN Call Transfer).....	92
2.5.2	Multi-party Conversation through ISDN Line (ISDN Conference)	95
2.5.3	Forwarding Your Calls without Occupying Your CO Line (ISDN Call Forwarding)	97
2.6	Before Leaving Your Desk.....	99
2.6.1	Built-in Voice Message	99
2.6.2	Forwarding Your Calls (Call Forwarding)	108
2.6.3	Forwarding Calls from a Hunting Group.....	116
2.6.4	Showing an Absent Message on the Caller's Telephone Display (Absent Message Capability).....	118
2.6.5	Preventing Other People from Using Your Telephone (Electronic Station Lockout).....	121
2.6.6	Leaving a Hunting Group (Log-In/Log-Out).....	122
2.7	Making/Answering an Announcement	123
2.7.1	Paging	123
2.7.2	Paging a Person and Transferring a Call	127
2.7.3	Answering a Paged Announcement.....	129
2.8	Setting the Telephone According to Your Needs	131
2.8.1	Setting the Alarm (Timed Reminder).....	131
2.8.2	Refusing Incoming Calls (Do Not Disturb [DND]).....	133
2.8.3	Receiving a Call Waiting (Call Waiting/Off-Hook Call Announcement [OHCA]/Whisper OHCA).....	135
2.8.4	Denying the Paged Announcement (Paging — DENY)	136
2.8.5	Automatic Selection of Calling/Connected Line Identification Presentation (CLIP/COLP)	137
2.8.6	Preventing Your Number Being Displayed on the Called Party's Telephone (Calling Line Identification Restriction [CLIR])	140
2.8.7	Preventing Your Number Being Displayed on the Calling Party's Telephone (Connected Line Identification Restriction [COLR])	141
2.8.8	Denying Other People the Possibility of Picking up Your Calls (Call Pickup Deny)	142
2.8.9	Denying Other People the Possibility of Joining Your Conversation (Executive Busy Override Deny)	143
2.8.10	Turning on the Background Music.....	144
2.8.11	Day/Night Service.....	145
2.8.12	Checking the Day/Night Service Status.....	147
2.8.13	Setting the Parallel Connected Telephone Ringer (Paralleled Telephone).....	148
2.8.14	Clearing the Feature Settings at Your Extension (Station Programme Clear).....	150
2.8.15	Identifying Malicious Callers (Malicious Call Identification [MCID]).....	151
2.8.16	Setting the Maximum Number of Busy Extension for a Hunting Group (Busy on Busy)	152
2.9	Using User-supplied Equipment.....	153
2.9.1	If a Doorphone/Door Opener is Connected.....	153
2.9.2	If a Host PBX is Connected.....	157
2.9.3	If a Voice Processing System is Connected.....	158
2.9.4	If an External Relay is Connected	165
2.9.5	If a Second Ringer is Connected	166
2.10	Using the Display Proprietary Telephone	167
2.10.1	Calling Using the Call Log (Incoming Call Log) [KX-T7433, KX-T7436, KX-T7230, KX-T7235 only].....	167
2.10.2	Recording a Call Log [KX-T7433, KX-T7436, KX-T7230, KX-T7235 only]	170
2.10.3	Using the KX-T7431, KX-T7433, KX-T7436 or KX-T7235	171
2.11	Accessing the Internet (Internet Access).....	184

2.11.1	Accessing the Internet (Internet Access).....	184
--------	---	-----

3 Operator Operation

3.1	Extension Control	186
3.1.1	Switching Level of Service	186
3.1.2	Changing the Settings.....	188
3.2	System Control.....	189
3.2.1	Forwarding a Waiting Call (Automatic Overflow/Hurry-up Transfer)	189
3.2.2	Turning on the External Background Music	190
3.2.3	Recording Company Greeting Outgoing Messages.....	191
3.2.4	Using the ANSWER/RELEASE Button [KX-T7441 only]	194
3.2.5	Printing the System Working Report	195

4 Customising Your Phone & System

4.1	Customising Your Phone (Station Programming).....	198
4.1.1	Customising Your Phone (Station Programming).....	198
4.1.2	Initial Settings.....	199
4.1.3	Customising the Buttons	202
4.1.4	Charge Fee Management [Pre-assigned extension only]	206
4.2	Customising Your System.....	208
4.2.1	Customising Your System	208
4.2.2	Date and Time Set (000).....	215
4.2.3	System Speed Dialling and Intelligent Call Handling Number Set (001).....	216
4.2.4	System Speed Dialling and Intelligent Call Handling Name Set (002).....	218
4.2.5	Extension Number Set (003).....	219
4.2.6	Extension Name Set (004).....	220

5 Appendix

5.1	Troubleshooting	222
5.1.1	Troubleshooting.....	222
5.2	Feature Number List	226
5.2.1	Feature Number List	226
5.3	Directory	231
5.3.1	Directory.....	231
5.4	What is This Tone?.....	240
5.4.1	What is This Tone?.....	240
5.5	Specifications	244
5.5.1	Specifications	244

6 Index

Index	247
-------------	-----

Section 1

Overview

This section briefly outlines your system.

1.1 Capacity

1.1.1 Capacity

You can connect the following number of extensions and outside lines to your system.

	Basic System	Module Expansion	Maximum Capacity
KX-TD612			
CO line	4	2	6
(ISDN (BRI) line)	(2)	(1)	(3)*
(Analogue CO Line)	—	1	1
Extension line	12	—	12

* ISDN (BRI) port 2 and ISDN (BRI) port 3 can be selected to be used for a CO line or ISDN extension line (Default : port 2 — CO line/port 3 — Extension). The maximum capacity of the system depends on the line selection. See below.

Line Selection	ISDN CO Line	ISDN Extension Line	Extension Line
3 ISDN (BRI) ports are selected for CO line	6	0	12
2 ISDN (BRI) ports are selected for CO line	4	8	12
1 ISDN (BRI) port is selected for CO line	2	16	12

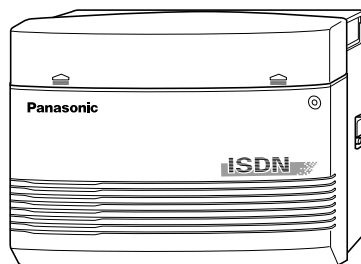

1.2 Names and Locations

1.2.1 Names and Locations

KX-TD612

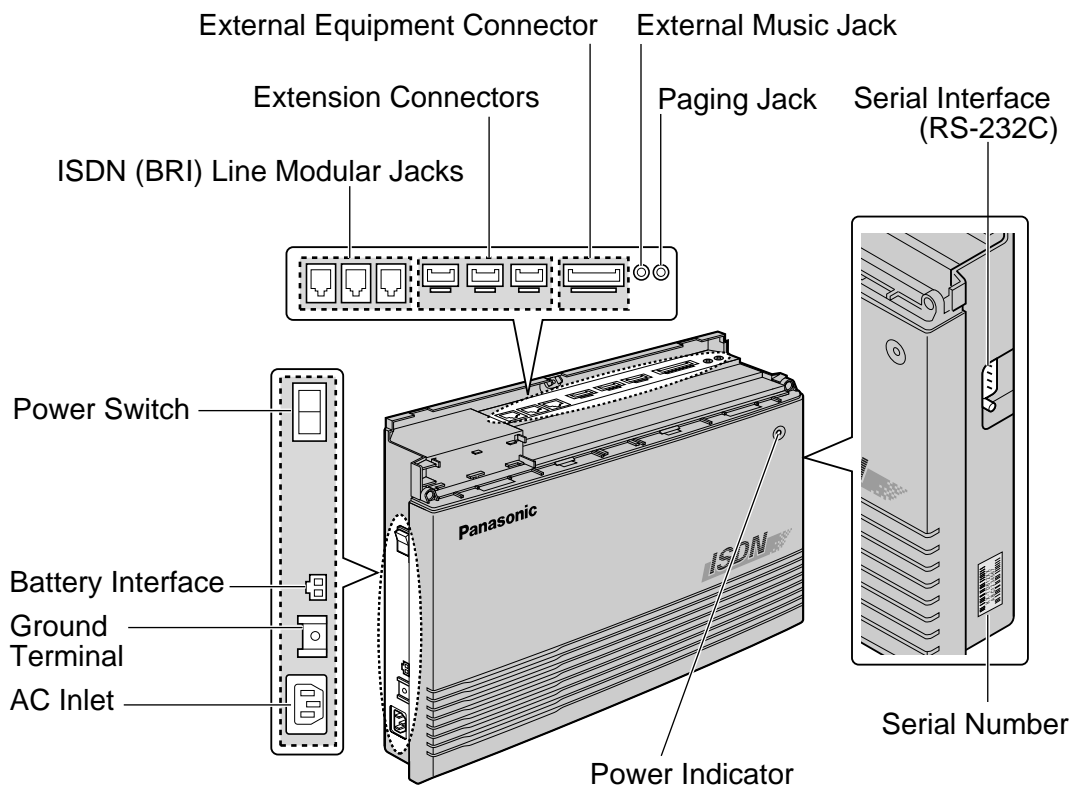

A Digital Proprietary Telephone (Example: KX-T7436)

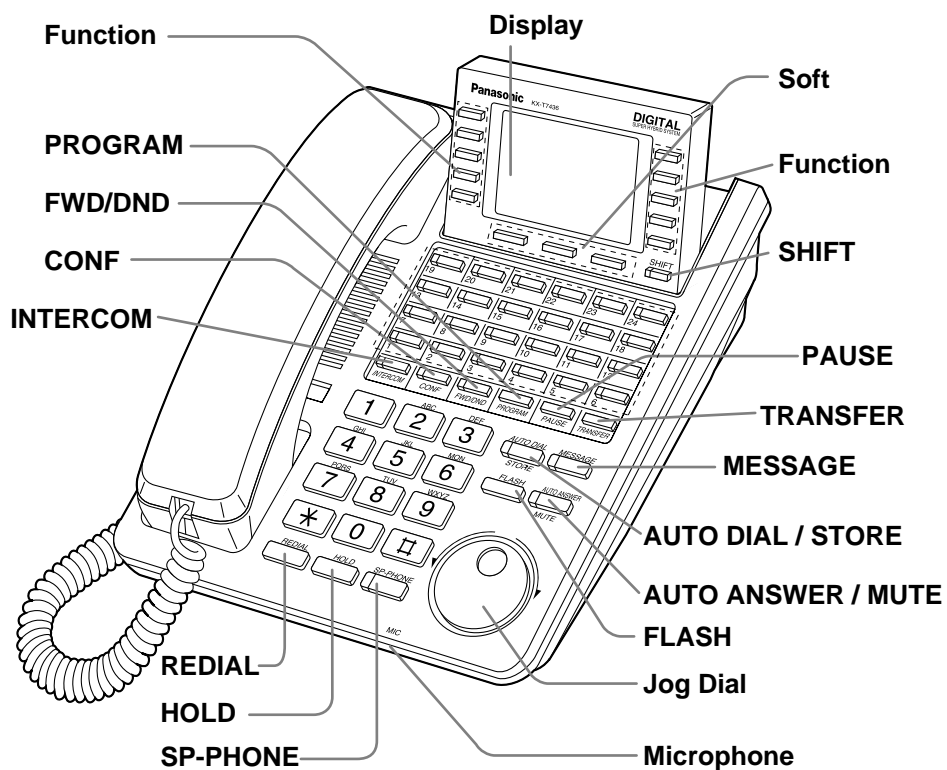

To open the front cover

1. Loosen the screw on the top front cover of the main unit.
The screw is attached to the front cover with springs so that it will not be lost.
2. Open the top front cover in the direction of arrow **A**.

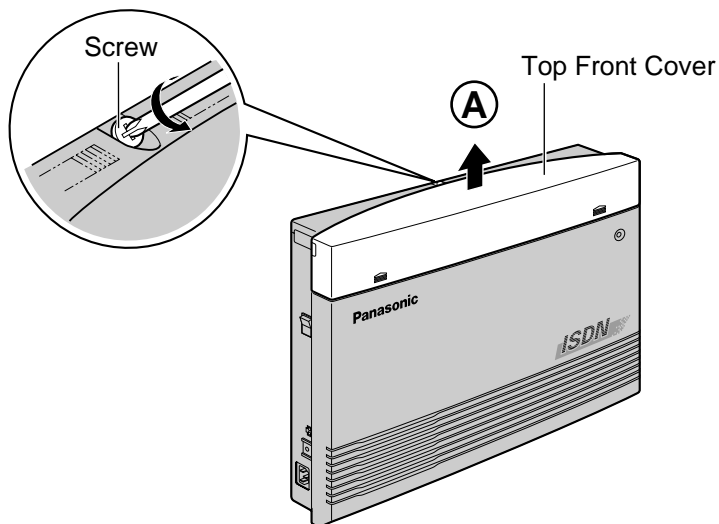

3. Loosen the 2 screws of the both sides of the unit.

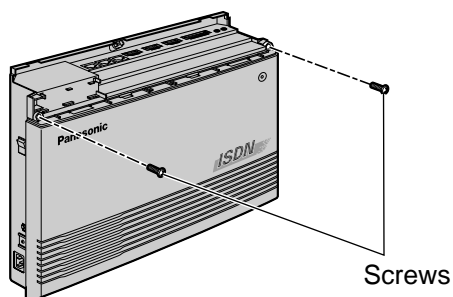

4. Open the front cover.

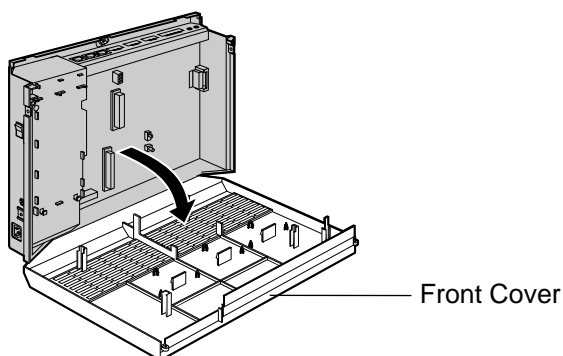
**To close the front cover**

1. Reverse the steps above.

1.3 Connection Example

1.3.1 Connection Example

This diagram shows you a connection example including optional equipment.

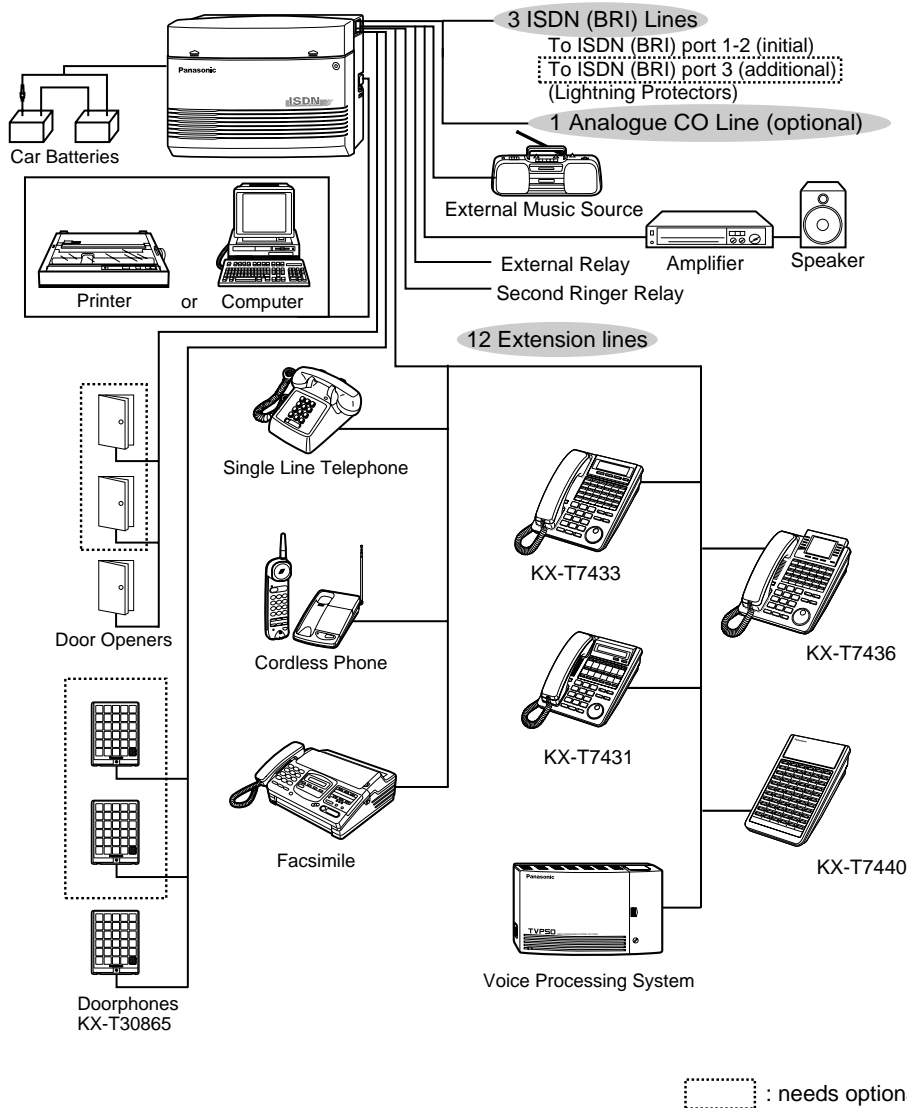

1.4 Adding Another Telephone in Parallel (EXtra Device Port [XDP])

1.4.1 Adding Another Telephone in Parallel

A Panasonic digital proprietary telephone and a single line telephone, including a facsimile, cordless telephone, etc., can be connected to 1 extension jack in parallel. There are 2 types of parallel connections.

- **EXtra Device Port (XDP)**

A digital proprietary telephone and a single line telephone

Each telephone has a different extension number and can work individually. For more information, contact your dealer.

- **Paralleled Telephone Connection**

Any digital proprietary telephone and a single line telephone

These telephones share the same extension number.

To ring the single line telephone, set to ring (on) if necessary. (Refer to 2.8.13 Setting the Parallel Connected Telephone Ringer (Paralleled Telephone) in this manual.)

Three examples of the parallel connections are shown below. System programming is required to determine the type of connection. Consult your dealer.

Method 1

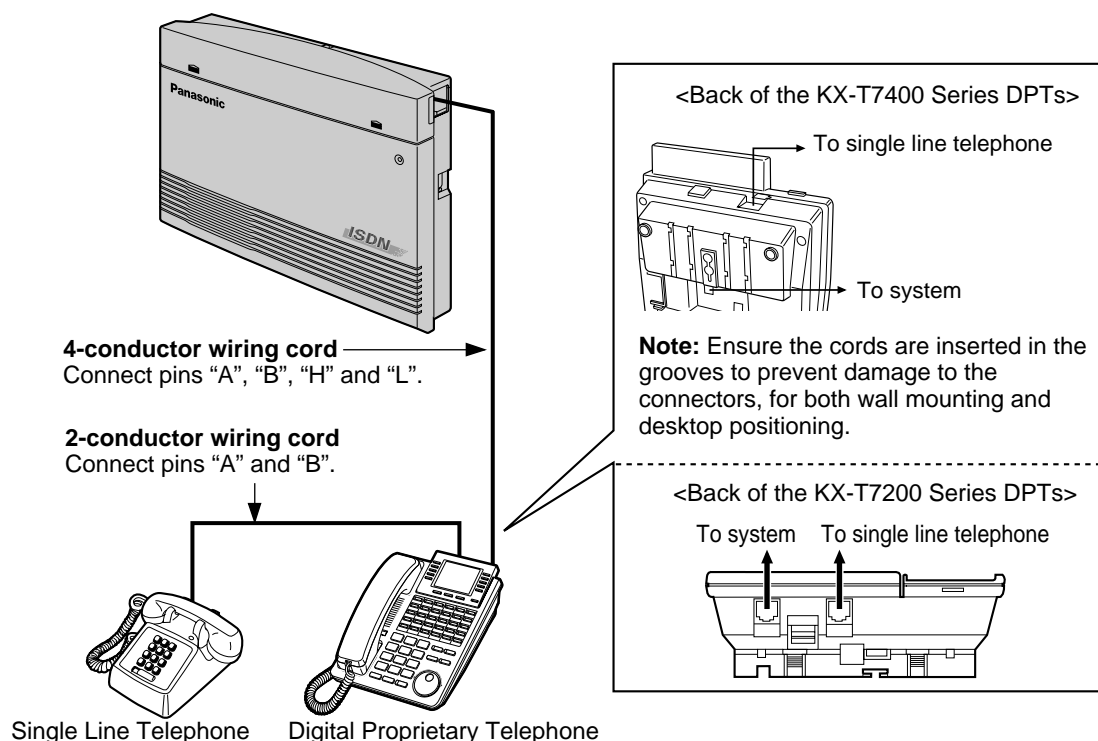

Method 2

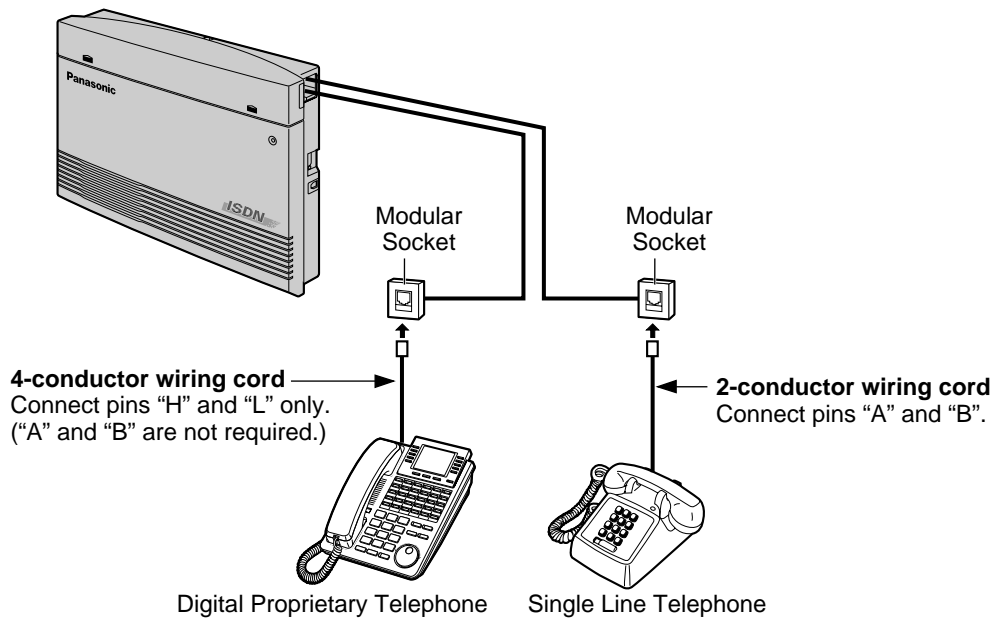

Method 3

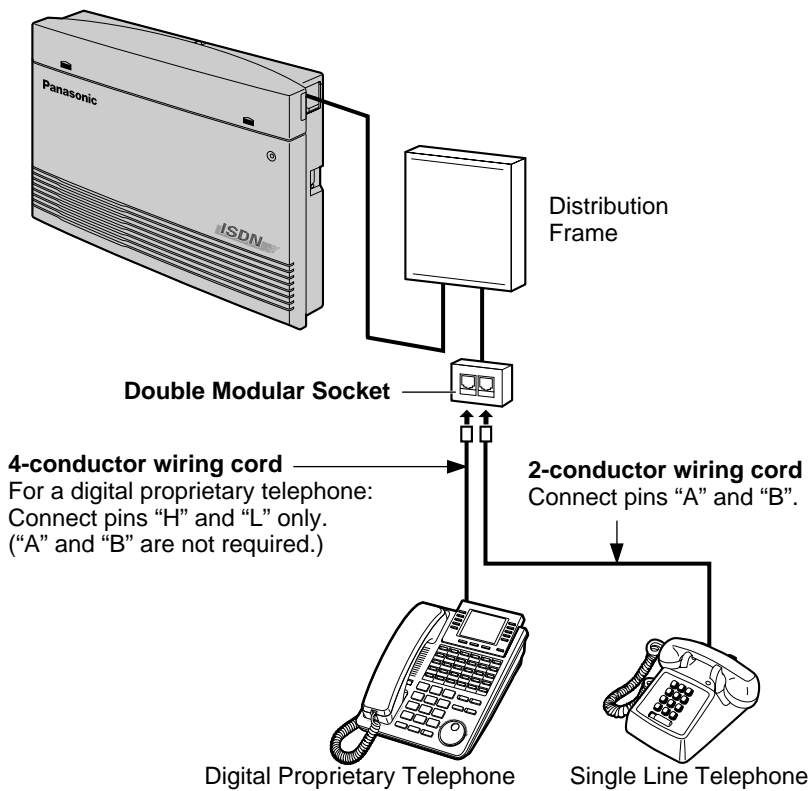

1.5 Restarting the System

1.5.1 Restarting the System

After starting the system, if it does not operate properly, restart. Only the following will be cleared. If your system does not operate properly, consult your dealer.

- Automatic Callback Busy (Camp-On) is cleared.
- Calls in system parking zones are cleared.
- Calls on Hold are terminated.
- Calls in progress are terminated.
- Calls on Exclusive Hold are cleared.

Using the Power Switch

1. Turn the power switch "OFF" once, and then turn it "ON".

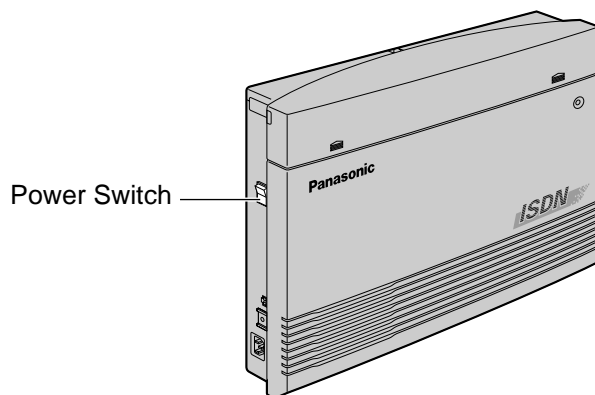

Section 2

Operation

This chapter shows you how to operate each feature step by step. Read this chapter to become familiar with the many useful features of this system.

2.1 Before Operating the Telephones

2.1.1 Before Operating the Telephones

◆◆ What kind of telephone can be used?

You can use a single line telephone (SLT), such as a rotary pulse telephone or a Panasonic digital proprietary telephone (DPT) such as the KX-T7436. Operate the feature depending on the telephone you are using. If you are using a Panasonic digital proprietary telephone with a special function button such as  and/or has a display, you can follow the operation with the button or display messages for easy programming.

If you use a large display telephone (e.g. KX-T7436), you can follow the displayed messages to operate the features.

If your telephone does not have function buttons and/or a display, you may operate the unit by entering a feature number instead. Follow the available operation with your telephone. If you use a console, you can use the buttons on the console as the buttons on the connected digital proprietary telephone.

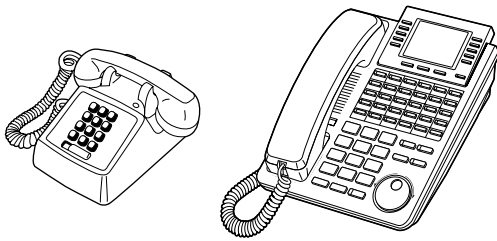

- If you use a Panasonic digital proprietary telephone which does not have function buttons, you may change one of the unused flexible buttons to a function button. Refer to 4.1.3 Customising the Buttons (Customising Your Phone & System).

◆◆ Feature Numbers

To operate certain features, you need to enter specified feature numbers (and an additional parameter, if required).

There are two types of feature numbers as follows:

- Flexible feature number
- Fixed feature number

Fixed feature numbers cannot be changed. However, you can change the flexible numbers to other numbers for easier use. If you want to change the numbers, consult your dealer. In this manual, the default numbers (factory installed) are used for operations.

A flexible number is shown as  (half-shaded key). Use the new programmed number if you have changed the feature number. Write the new number in 5.2 Feature Number List (Appendix).



If you use a single line telephone which does not have the * or # keys;
it is not possible to access features that have * or # in their feature numbers.

◆◆ Tones

You will hear various tones, during or after an operation, for confirmation. Refer to 5.4.1 What is This Tone? (Appendix).

◆◆ Display

In this manual, you will see "the display ...". This refers to the display of a Panasonic digital proprietary telephone. If your telephone is not a Panasonic digital proprietary telephone with a display, the message will not be displayed.

If you use a Panasonic digital proprietary telephone with display, the display helps you confirm the settings. For example, when you set the Do Not Disturb feature, the display shows "Do Not Disturb". Some digital proprietary telephones also give you easy access to operations. A message is displayed depending on the operation. By pressing the corresponding button on the side or bottom of the display, or rotating a jog dial, you can access the desired feature. For example, if turning background music on becomes available, "BGM" will be shown on the display. Follow the instructions in each operation.



Furthermore, depending on the digital proprietary telephone with display, you can operate features or make calls using the display message. Refer to 2.10 Using the Display Proprietary Telephone.



◆◆ Your Extension Number











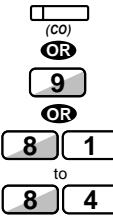



If you use a Panasonic digital proprietary telephone with display, you can check your own extension number on the display. Refer to 4.2.1 Customising Your System.

◆◆ Restrictions

Some features may be restricted at your extension under system programming. Consult your manager or dealer.



















◆◆ Icon Descriptions





The following icons show you the feature availability, notes and action to operate the features. While operating the unit, you can easily refer to the Icons noted on the inside back cover of this manual.

	This feature cannot be operated with a single line telephone.		Seize an external line (one of the following). <ul style="list-style-type: none"> • Press the CO button. • Dial automatic line access number 9. • Dial outside line number 81 to 84.
	Related Programming Title See "Programming", if necessary.		Press the Call button on the Doorphone.
	Off-hook (one of the following). <ul style="list-style-type: none"> • Lift the handset. • Press the SP-PHONE button. • Press the MONITOR button. (To start talking, lift the handset.) 		On-hook (one of the following). <ul style="list-style-type: none"> • Hang up. • Press the SP-PHONE button. • Press the MONITOR button.
	Press the corresponding function button on the digital proprietary telephone. (See to "When You Use a Panasonic Digital Proprietary Telephone".)		Wait for an answer.
	Enter the required number. <Example>  Enter the account code.		Talk.
	Dial an extension number.		You will hear a confirmation, dial, ring or ringback tone. <ul style="list-style-type: none"> C. Tone: confirmation tone D. Tone: dial tone R. Tone: ring tone R. B. Tone: ringback tone
	Dial the telephone number.		One short beep

◆◆ When You Use a Panasonic Digital Proprietary Telephone

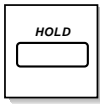
If you use a Panasonic digital proprietary telephone and the DSS Console, they may have some of the useful function buttons listed below. These buttons make operations simple. The illustrations may differ from the buttons on your telephone.

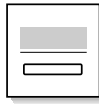
	<p>ANSWER: Used to answer an incoming call.</p>		<p>INTERCOM: Used to make or receive an intercom call.</p>
	<p>AUTO ANSWER/MUTE: Used to receive an incoming intercom call in the hands-free mode or mute the microphone during a conversation.</p>		<p>MESSAGE: Used to leave a message waiting indication or call back the party who left the message waiting indication /used to replay voice messages.</p>
	<p>AUTO DIAL/STORE: Used for System Speed Dialling or storing programme changes.</p>		<p>MODE: Used to shift the display to access various features.</p>
	<p>CO: Used to make or receive an outside call. A Loop-CO button supports all lines. Pressing this button seizes an idle line automatically. (Button assignment is required.) (Only the CO "number" (e.g. 1, 2) may be shown on some telephones.)</p>		<p>PAUSE: Used to insert a pause during dialling.</p>
			<p>PROGRAM: Used to enter and exit the Station Programming mode.</p>
	<p>DSS: Used to access the extension. (Only the "S" may be shown on some telephones.)</p>		<p>Programmable Feature: Located on the upper part of the CO button or on the Console. Assigns the desired button and used to access the stored function. Mostly used as a one-touch dialling button. (Only the "F and number" may be shown on some telephones.)</p>
	<p>R (FLASH): Sends a flash signal to the Central Office or a host PBX to access their features (External Feature Access). This button is applicable when the PBX has CO lines, not when it only has ISDN lines.</p>		
	<p>Function: Located beside the display. Used to perform the displayed function or operation.</p>		<p>RELEASE: Used to disconnect the line.</p>
	<p>Call Forwarding/Do Not Disturb: Used to perform Call Forwarding or Do Not Disturb.</p>		<p>SELECT: Used to select the displayed function or to call the displayed phone number.</p>
	<p>Jog Dial: Used to adjust the volume and the display contrast or select desired items for each function.</p>		<p>SHIFT: Used to access the second level of Soft Button functions.</p>

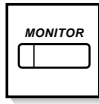
	<p>HOLD: Used to place a call on hold.</p>		<p>VOICE CALL/MUTE: Used to monitor an intercom call automatically, but it cannot be used for hands-free conversations. It also mutes the handset microphone during a conversation.</p>
	<p>Speakerphone: Used for the hands-free operation.</p>		<p>Soft: Used to perform a function or operation appearing on the bottom line of the display.</p>
	<p>TRANSFER: Used to transfer a call to another party.</p>		<p>MONITOR: Used for hands-free dialling. You can monitor the party's voice hands-free.</p>
<p>If the term is in parentheses like (Account) in this section, it means a flexible button has been made into an "Account" button.</p>			

◆◆ **Using a Jog Dial**

The Jog Dial can be used for the display contrast and the volume control or you can search for desired items on the display. Rotate the Jog Dial in the either direction as desired. The contrast or the volume level and the items will change as follows:

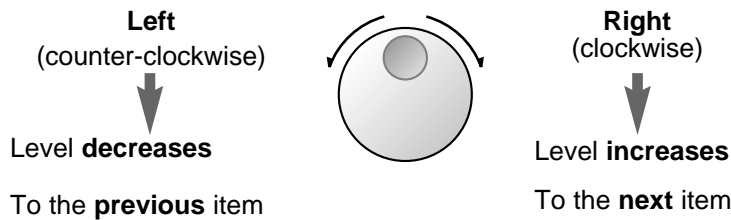

◆◆ How to Follow the Steps

A sample operation is shown below.

2.2.5 Calling without Restrictions

— Using an account code — To an extension refusing the call

Feature title

Sub feature title

◆◆ **Using an account code (Account Code Entry)**

An Account Code gives information about outside calls for accounting and billing purposes. You may not be able to make an outside call without an account code entry. A mode is assigned to each user. Ask your manager for your mode.

DPT/SLT

Description

Operation steps
The description of the icons are explained in "2.1.1 Before Operating the Telephones — Icon Descriptions."

Conditions

- **A Panasonic digital proprietary telephone user** can enter an account code during a conversation or when hearing a reorder tone after the other party hangs up.
- **If you enter the wrong code**, press the “*” key while entering the account code and then re-enter the code.
- **To cancel the entry**, press the Account button while entering the code.
- **For your convenience**, you can store the code with the phone number in memory (e.g. Speed dialling).
- **If you hear a reorder tone**, the entered account code is wrong. Enter the correct code.
- You may give a specified account cord to extension users and check their telephone usage. You can specify an account cord to each client and check the call duration.

Hints

Customising Your Phone

- 4.1.3 Customising the Buttons
Create or re-arrange an Account button.

Programming References: The related or required programming is noted. To program, see “Customising Your Phone & System”.

2.1.2 LCD Language Change

You can select the desired language for the display. Selections vary depending on the area of use.

Note

- Area 1: Polish standards are supported.
- Area 2: Hungarian standards are supported.
- Area 3: Greek standards are supported.

◆ In Area 1

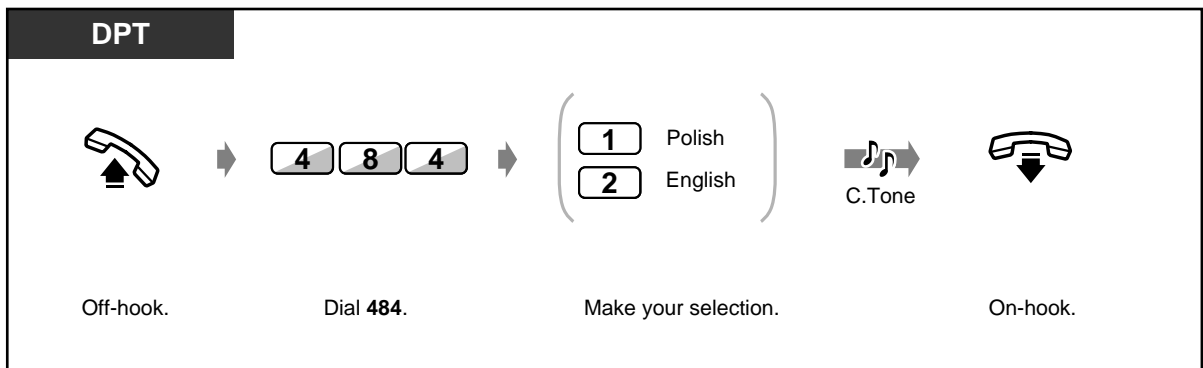

◆ In Area 2

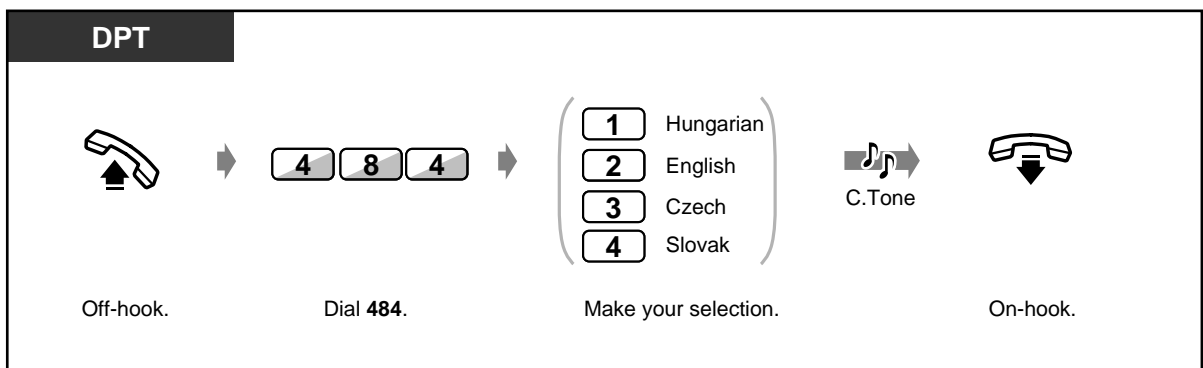

◆ In Area 3

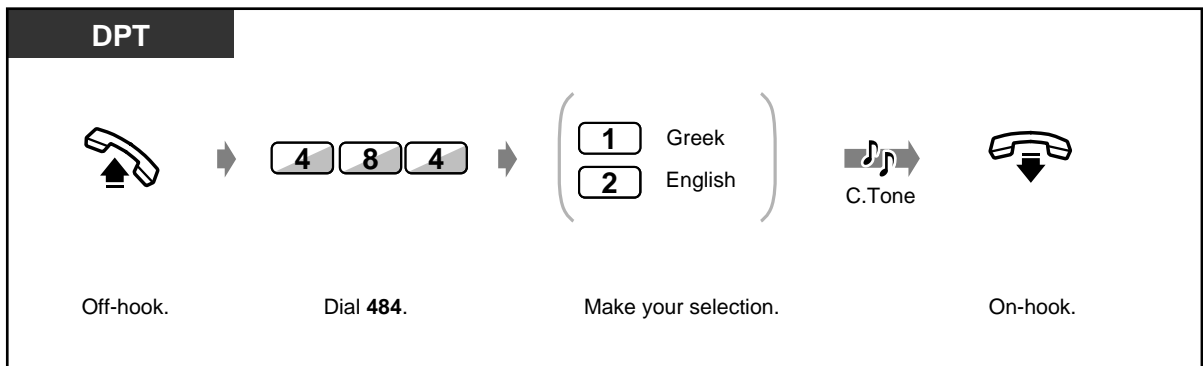



- This feature is available for the users of KX-T7433. Other digital proprietary telephones support English only.

2.1.3 For ISDN Extension Users

ISDN extensions include ISDN terminal equipment such as telephones, facsimiles or personal computers connected to the ISDN (BRI) port (port 2 and port 3) on the main unit KX-TD612. A maximum of 8 ISDN extensions can be connected to each ISDN (BRI) port with point-to-multipoint configuration. However, only 2 units can be used simultaneously. Terminal equipment can be addressed individually with Multiple Subscriber Numbers (MSN). The MSN consists of the ISDN extension number and an additional digit, 00 through 99. If MSN is not assigned, all equipment on the same ISDN (BRI) Extension bus are called simultaneously.

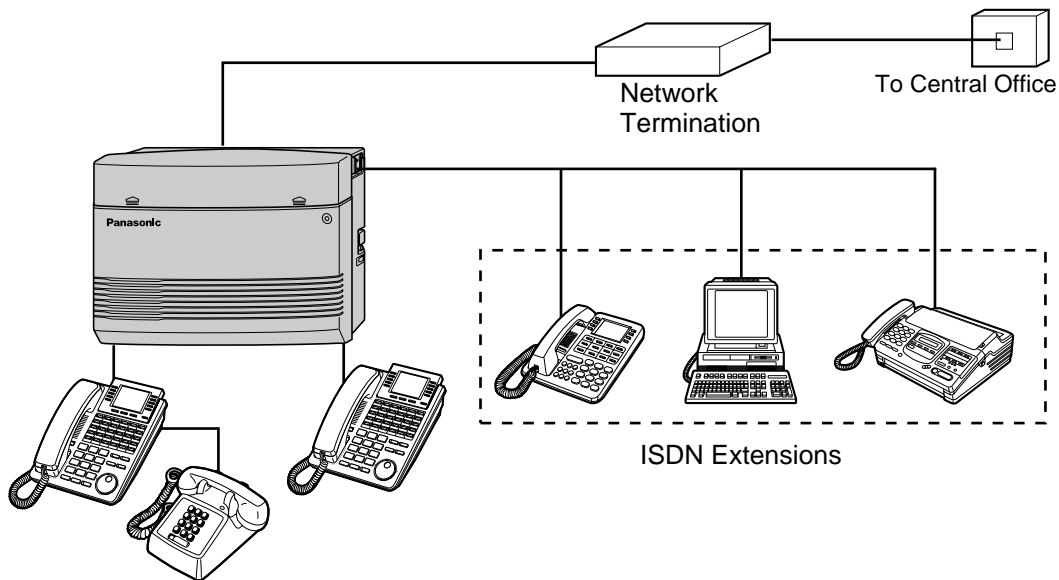

- A primary and a secondary Class of Service (COS) can be assigned per port.

2.2 Making Calls

2.2.1 Basic Calling

- Calling another extension
- Calling an external party

◆◆ Calling another extension

◆ To another extension (Intercom Call)

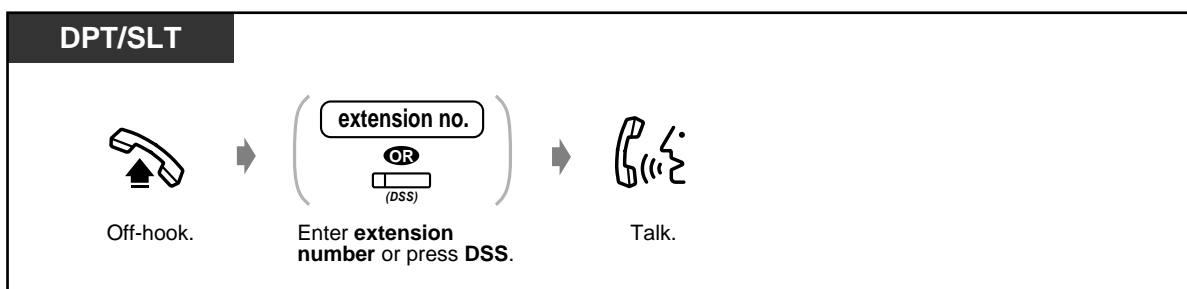

<Example>

When you call Mr. Thomas....

Mr. Thomas's extension number is 123.

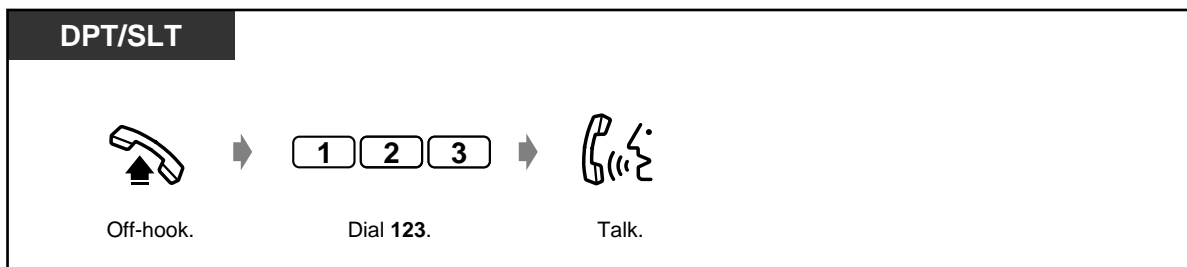

- The DSS button light shows the current status as follows:

Off: The extension is idle.

Red on: You or another extension is using the line.



- **Hands-free operation**
You can have a conversation in the hands-free mode using the SP-PHONE button. You can then perform other tasks at the same time.
- **Do you have an extension directory?**
Complete the directory in 5.3 Directory and make a photo copy for your reference.
- **For quick operation**
If you are an operator or dial some extensions frequently, the DSS button is useful.
- **Confirming the dialed number before connecting**
You can go off-hook after confirming the number you dialed. If you misdial, press "*" to clear each number from the right or press the R (FLASH) button to clear all numbers.



Customising Your Phone

- 4.1.3 Customising the Buttons
Create or re-arrange a DSS button.

Customising Your System

- 4.2.3 System Speed Dialling and Intelligent Call Handling Number Set (001)
- 4.2.4 System Speed Dialling and Intelligent Call Handling Name Set (002)

◆ To an operator (Operator Call)

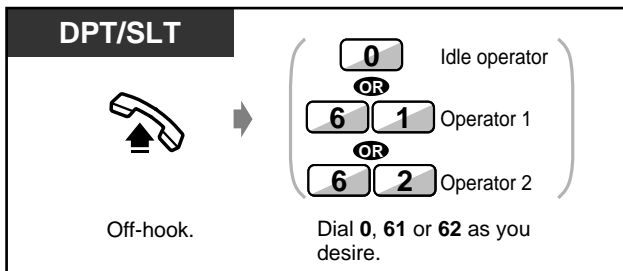

◆◆ Calling an external party

You have to seize an outside line before dialling an outside phone number because external calls are made via your system.

Select one of the following methods:

- Press an idle button.
- Dial automatic line access number .
An idle line is selected automatically.
- Dial outside line number to .

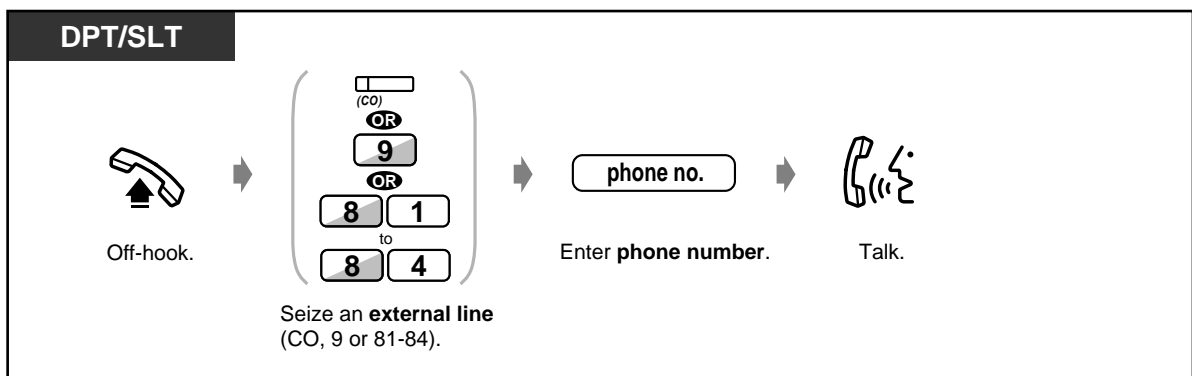



- The CO button light shows the current status as follows:
Off: The line is idle.
Green on: You are using the line.
Red on: The line is in use.
- CO1 to CO7 correspond to outside line numbers 81 to 84 respectively.
 CO 1,2 : 81
 CO 3,4 : 82
 CO 5,6 : 83
 CO 7 : 84
- **Emergency call**
 You can dial pre-programmed emergency numbers without any restrictions.
 Consult your dealer.



- **Hands-free operation**
 You can have a conversation in the hands-free mode using the SP-PHONE button. You can then perform other tasks at the same time.
Helpful hints for hands-free operation
 Use your telephone in a quiet room for best performance.
 If the other party has difficulty hearing you, decrease the volume.
 If you and the other party talk at the same time, parts of your conversation will be lost. To avoid this, talk alternately.
- **To select the less expensive line automatically**, dial "9" or press the Loop-CO button to seize a line. (Automatic Route Selection)
- **Confirming the dialed number before connecting**
 You can go off-hook after confirming the number you dialed. If you misdial, press "*" to clear each number from the right or press the R (FLASH) button to clear all numbers.
- **Call information**
 The following information can be referred to by repeatedly pressing the CO button in use.
 Phone number (outgoing call) or call duration (incoming call)
 Meter
 Call charge
- **To call another party without hanging up**, just press the terminate button, re-access an outside line and dial the new phone number.



Customising Your Phone

- 4.1.2 Initial Settings — **Preferred Line Assignment — Outgoing**
 Select the seized line when going off-hook.
- 4.1.3 Customising the Buttons
 Create or re-arrange the terminate button.
- 4.1.4 Charge Fee Management [Pre-assigned extension only]

2.2.2 Easy Dialling

This is convenient for frequently dialled phone numbers.

- With one touch button
- Using numbers stored at your extension
- Using numbers stored in the system
- To a pre-set party by going off-hook
- Using a quick dialling number
- To a phantom extension

◆◆ With one touch button (One-Touch Dialling)

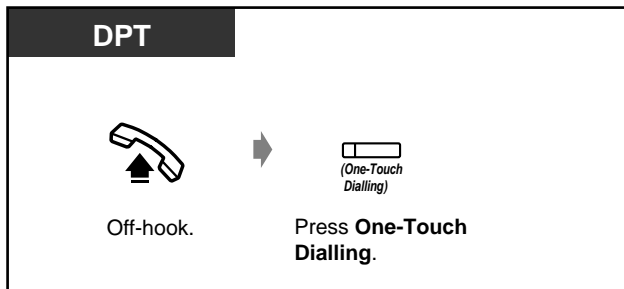

Customising Your Phone

- 4.1.2 Initial Settings—**Full One-Touch Dialling Assignment**
Allow or cancel the one-touch operation while on-hook. (Default: Allow)
- 4.1.3 Customising the Buttons
Create or re-arrange the One-Touch Dialling button and store the desired number, phone number, feature number, etc.



- **To dial to a third party with holding the present call**, refer to 2.4.2 Holding a Call — One-touch dialling with automatic hold.

◆◆ Using numbers stored at your extension (Station Speed Dialling)

You can store up to 10 numbers at your extension for your personal use.

◆ To store a phone number

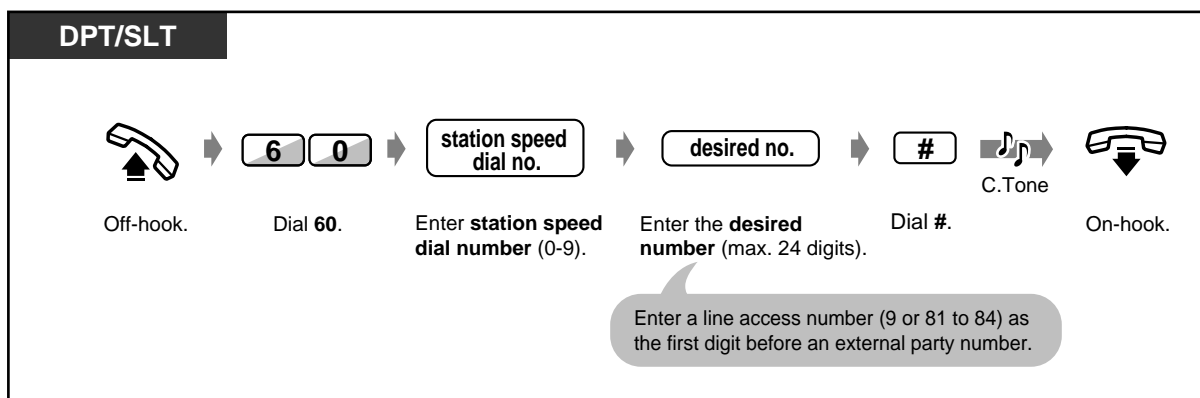

- "*" , "#", PAUSE, SECRET and HYPHEN can also be stored as digits.

- 2.10.3 Using the KX-T7431, KX-T7433, KX-T7436 or KX-T7235 — storing the names and numbers for station speed dialling.

◆ **To dial**

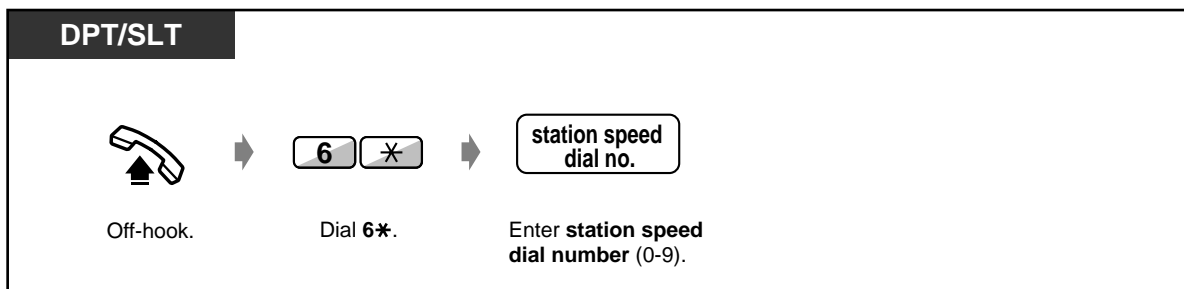

◆◆ **Using numbers stored in the system (System Speed Dialling)**

Up to 500 parties can be stored in the system. Refer to the directory in 5.3.1 Directory.

◆ **To dial**

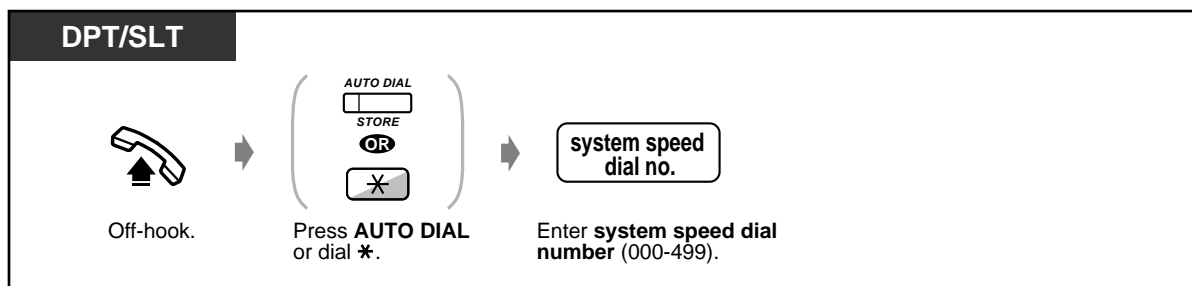

- If a DDI/CLIP key is assigned to a flexible button on your digital proprietary telephone (DPT), you can easily make a call with this key. Up to 24 DDI/CLIP keys can be located on a DPT, and the key is linked to the location number of System Speed Dialling number. One System Speed Dialling number can be assigned per CO button. To make a call, press the DDI/CLIP key.
- More than one speed dial number can be used for long telephone numbers, if the number is divided when stored.

<Dialling Example>

If the number is divided and stored in system speed dial numbers 001 and 002:

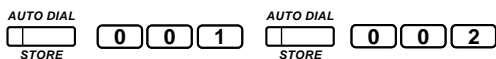

- **To store a phone number**, refer to 4.2.3 System Speed Dialling and Intelligent Call Handling Number Set (001).



Customising Your System

- 4.2.3 System Speed Dialling and Intelligent Call Handling Number Set (001)
- 4.2.4 System Speed Dialling and Intelligent Call Handling Name Set (002)

Customising Your Phone

- 4.1.2 Initial Settings—**Full One-Touch Dialling Assignment**
Allow or cancel the one-touch operation while on-hook. (Default: Allow)
- 4.1.3 Customising the Buttons
Create or re-arrange a DDI/CLIP key.

◆◆ **To a pre-set party by going off-hook (Pickup Dialling)**

You can make an outside call simply by going off-hook if you pre-assigned a telephone number.

◆ **To store a phone number**

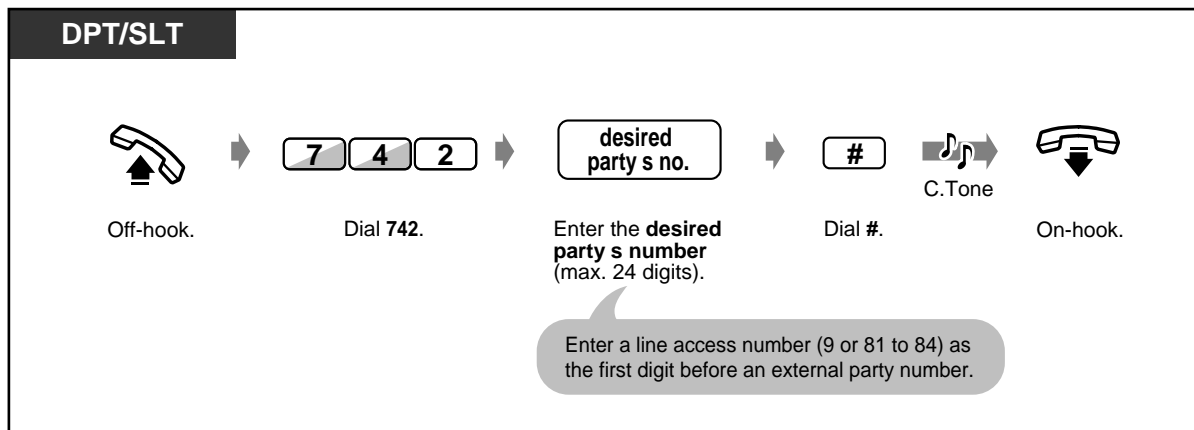

◆ **To set/cancel**

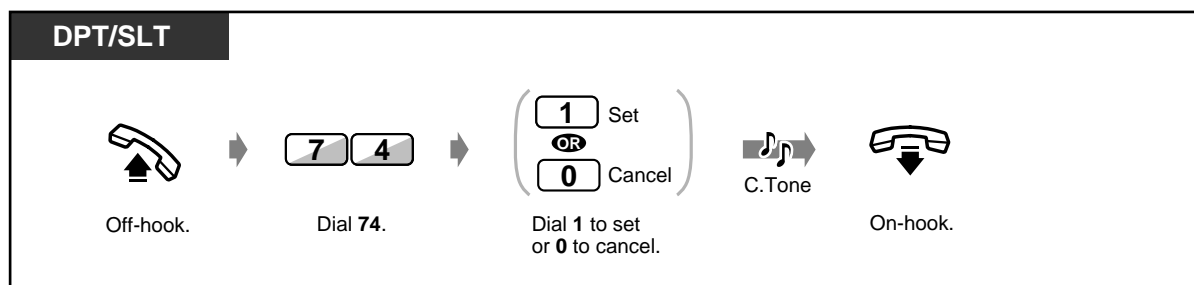

◆ **To dial**



- You can set or cancel this feature by simply pressing the Pickup Dialling button. If set, the button light turns red.
- **To call another party**, dial the desired party's phone number before the pre-set line is connected. (Default: 1 second)
- "*" can also be stored as a digit.
- If there is a new message which is not yet replayed, the Pickup Dialling feature does not work.



Customising Your Phone

- 4.1.3 Customising the Buttons
Create or re-arrange a Pickup Dialling button.

◆◆ Using a quick dialling number (Quick Dialling)

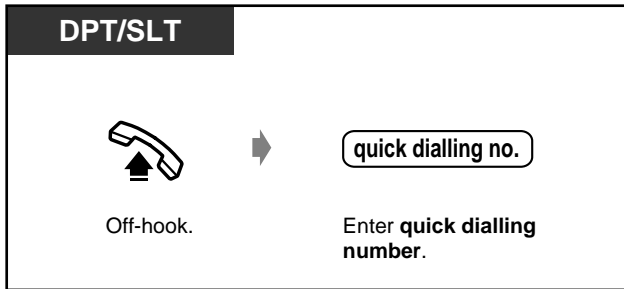

- The quick dialling number is determined by system programming. Consult your dealer.
- Make use of "Quick Dialling" in 5.3.1 Directory.

◆◆ To a Phantom extension

You can call extensions associated with a Phantom extension. The call arrives at all extensions who have the corresponding Phantom extension button.

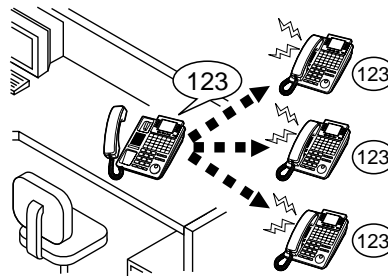

◆ To call to a phantom extension

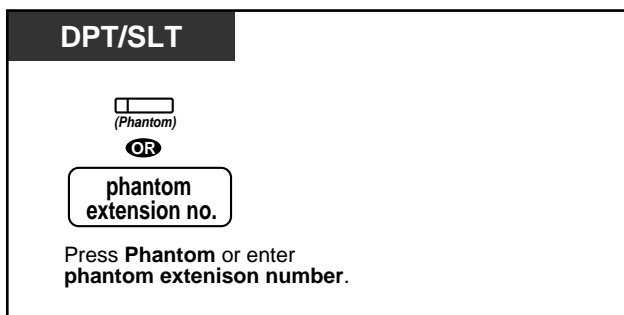

◆ **To answer**

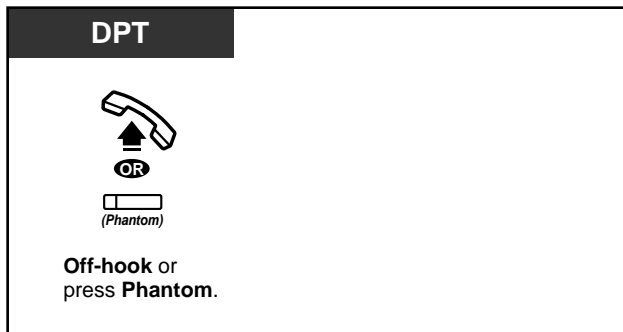

- The Phantom extension button light shows the current status as follows:
 - Off:** Idle
 - Red on:** You are calling a phantom extension.
 - Flashing green:** Incoming call
- To set ringing or not, refer to "Customising Your Phone".



Customising Your Phone

- 4.1.3 Customising the Buttons
 - Create or re-arrange a Phantom extension button.

2.2.3 Redial

This is convenient when calling the same external party again.

- Redialling the last number you dialled
- Saving the number and redialling



- Up to 24 digits can be programmed and redialled. The line access number is not counted as a digit.



• **Automatic Redial:**

This is a special feature for the digital proprietary telephones, that provides automatic redialling of the last dialled, saved number or outgoing call log, if the called party is busy. If the Last Number Redial, Saved Number Redial, Outgoing Call Log operation or Notebook function is performed handsfree, the telephone set will hang up and try again after a pre-determined period of time. Detailed operations for redialling the last dialled or saved number are shown below. To redial using the Outgoing Call Log, refer to 2.10.3 Using the KX-T7431, KX-T7433, KX-T7436 or KX-T7235 — Using the KX-T7436/Using the KX-T7235.



Customising Your Phone

- 4.1.2 Initial Settings—**Full One-Touch Dialling Assignment**
Allow or cancel the one-touch operation while on-hook. (Default: Allow)

◆◆ Redialling the last number you dialled (Last Number Redial)

◆ To dial

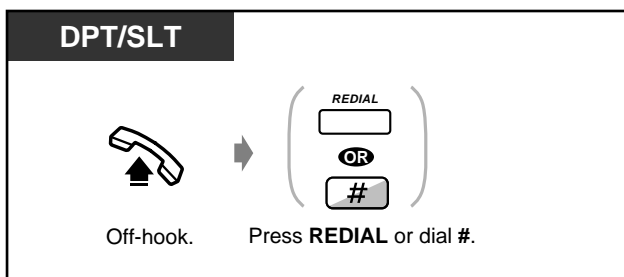

◆ To dial automatically (Automatic Redial)

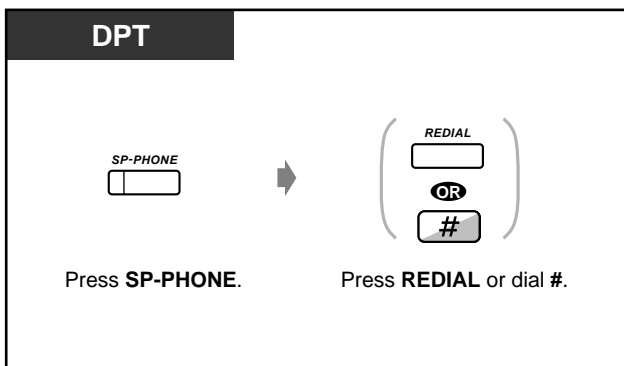



- To cancel the Automatic Redial, go off-hook or press **CO**, **INTERCOM**, **0** through **9**, *****, or **#** button.

◆◆ Saving the number and redialling (Saved Number Redial)

The saved number is programmed until another number is stored.

◆ To save

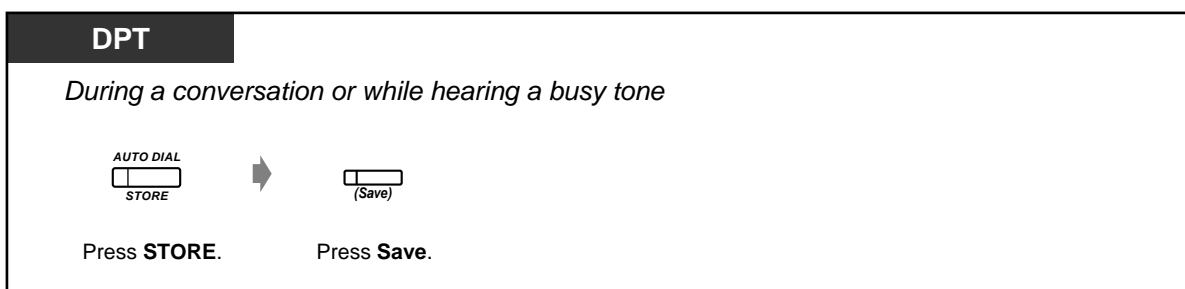

◆ To dial

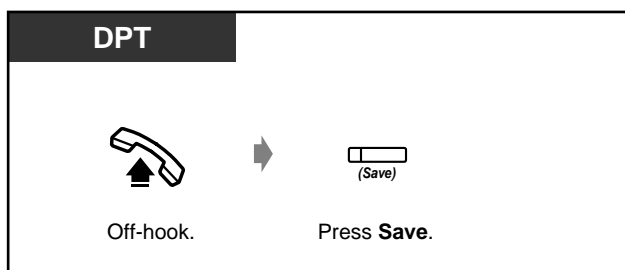

◆ To dial automatically (Automatic Redial)

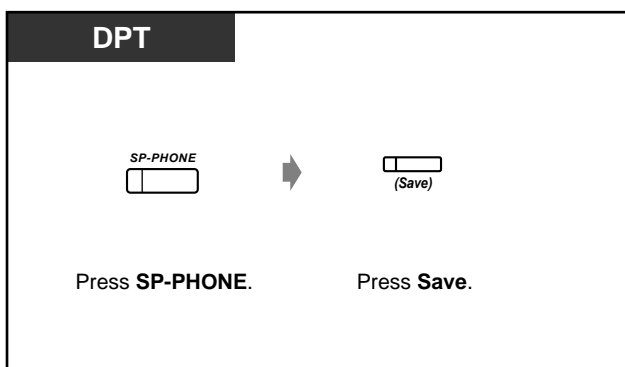

- To cancel the Automatic Redial, go off-hook or press **CO**, **INTERCOM**, **0** through **9**, *****, or **#** button.



Customising Your Phone

- 4.1.3 Customising the Buttons
Create or re-arrange a SAVE button.

2.2.4 When the Dialed Line is Busy or There is No Answer

- Reserving a busy line
- Completing a call to a busy party on an ISDN line
- Sending a call waiting tone
- Leaving a message waiting indication
- Joining an existing call

◆◆ Reserving a busy line (Automatic Callback Busy)

You can set the telephone to receive callback ringing when a dialed line becomes idle. When you answer the callback ringing:

For an outside call: The line is seized.

For an intercom call: The called extension starts ringing automatically.

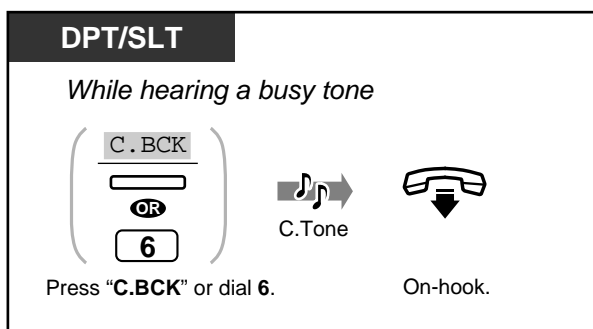

◆ To answer a callback ringing and call

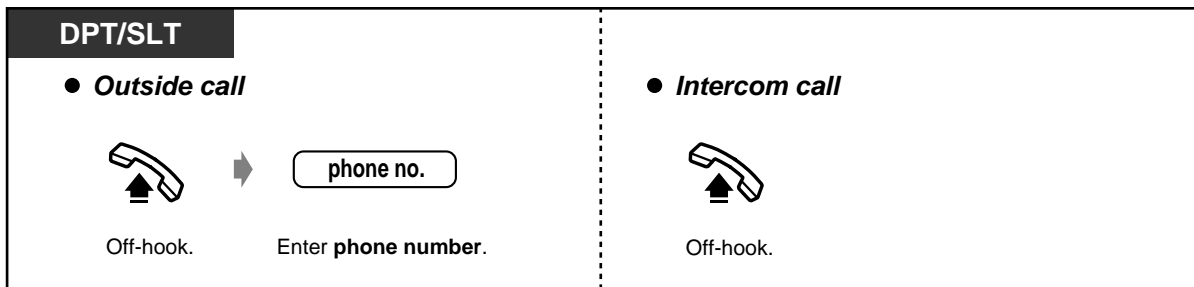



- If you connect to an ISDN line, the busy party will automatically be dialled. "CCBS" will be displayed instead of "C.BCK". Refer to "Completing a call to a busy party on an ISDN line" right below.

◆◆ **Completing a call to a busy party on an ISDN line (Completion of Calls to Busy Subscriber [CCBS])**

You can set the telephone to receive call-back ringing when a busy called party on an ISDN line becomes free. When you answer the call-back ringing, the called party's telephone number is automatically dialled.

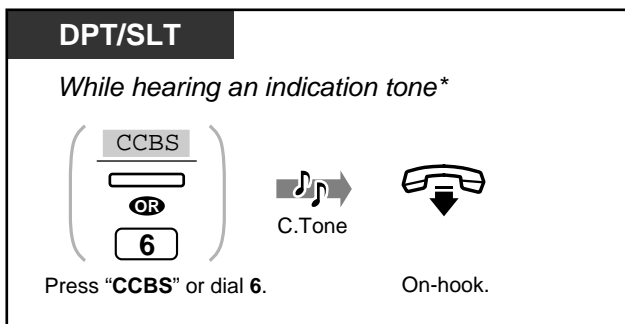

◆ **To answer and call**



◆ **To cancel**

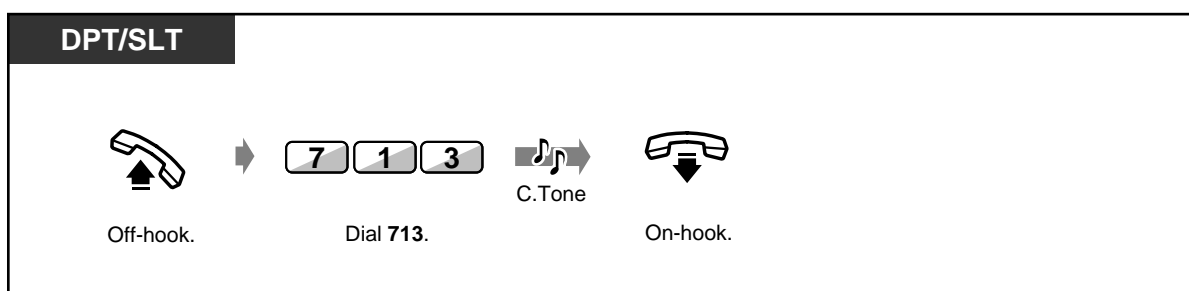

- If you do not answer a callback ringing during 4 callback rings, this feature will be cancelled.
- *Indication tone

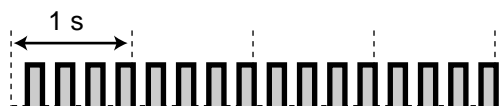



- Availability of this feature depends on your telephone company.
- The CCBS feature is in accordance with the ETS 300 359. (ETS: European Telecommunication Standard)

◆◆ **Sending a call waiting tone (Busy Station Signalling [BSS])**

The party will know your call is waiting.

DPT/SLT

While hearing a busy tone

BSS

OR

2

Press "BSS" or dial 2.



- **If "BSS" is not displayed or you hear a reorder tone**, this feature has not been set at the other party's phone. This feature is only available if the called extension has set the "Call Waiting" feature.
- **Depending on the other party's telephone**, the "Off-Hook Call Announcement (OHCA)" and the "Whisper OHCA" functions can be applied. You can talk to the other party through the speaker and the microphone (OHCA) or you can send a call announcement through the handset (Whisper OHCA), while they are having another conversation using the handset.

◆◆ Leaving a message waiting indication (Message Waiting)

The called extension receives a message waiting indication (MESSAGE button light turns on and/or indication tone is emitted when going off-hook) to call you back.

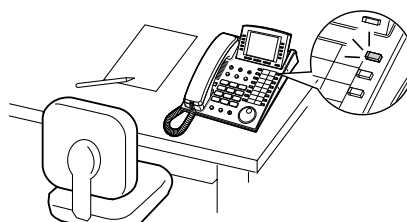

◆ To leave a message waiting indication

DPT/SLT

When the called extension is busy or does not answer



 OR



Press **MESSAGE** or dial **4**.



 C.Tone



 On-hook.

◆ To leave/cancel a message waiting indication

DPT/SLT



 Off-hook.



 Dial **70**.

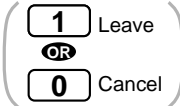

 Dial **1** to leave or **0** to cancel.

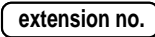

 Enter **extension number**.



 C.Tone



 On-hook.

T7431



 Press **MODE** until "Feature Access" is displayed.



 Rotate **Jog Dial** until "MSG Off" or "MSG On" is displayed.

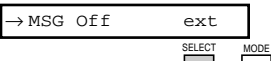

 Press **SELECT**.
 "MSG On": Leave
 "MSG Off": Cancel.

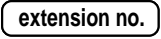

 Enter **extension number**.



 C.Tone



 On-hook.

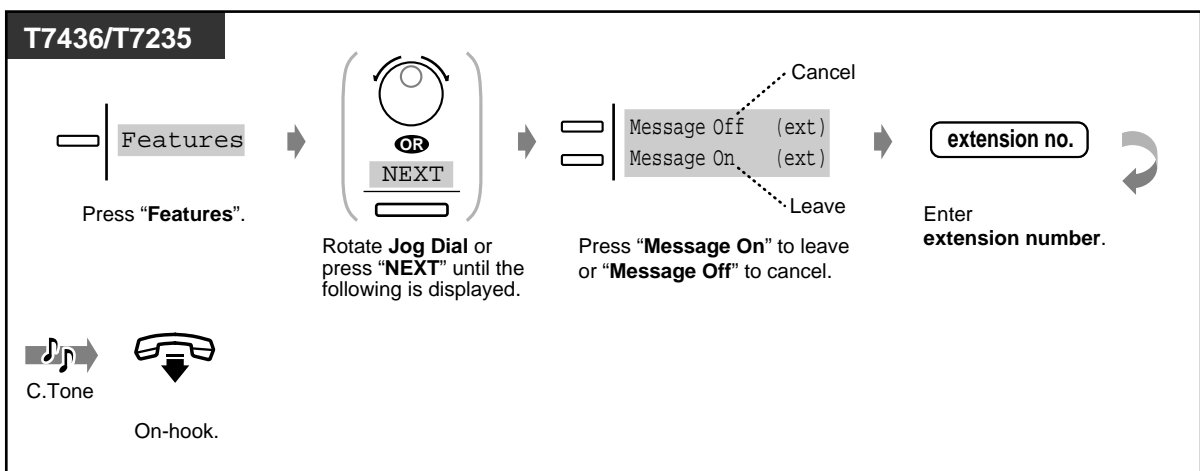
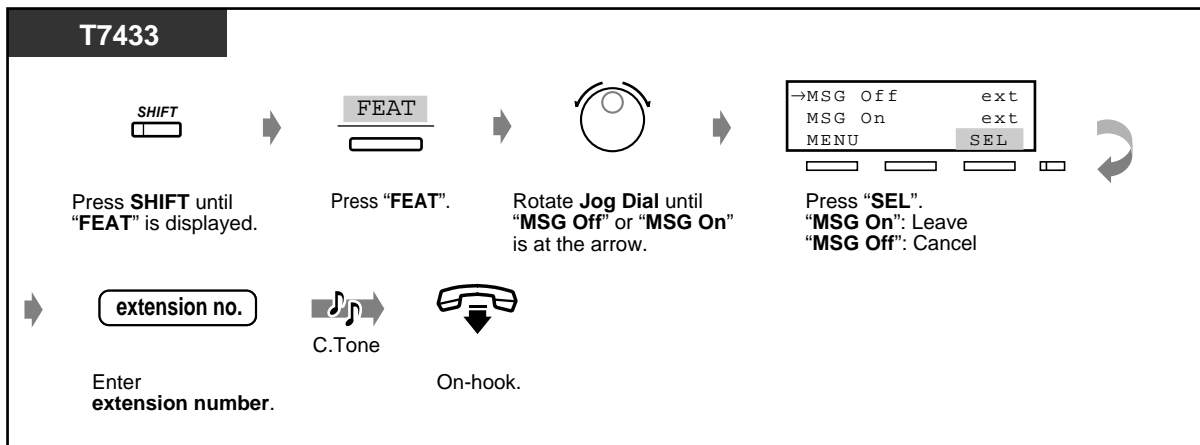

◆ **To check and select the party**

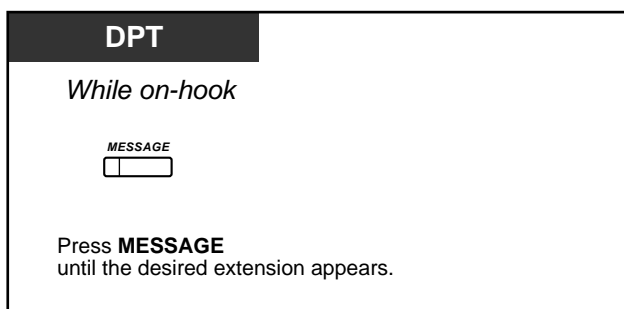



- The extension number and name are shown in the received order.
- You can also select the party who left the voice message in your mail box of a voice processing system. Refer to 2.9.3 If a Voice Processing System is Connected.
- Single line telephone users will hear ring tone 5 as message waiting indication while on-hook.

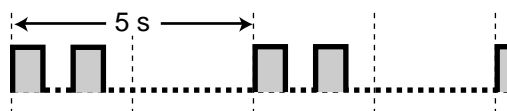

- If the indication for the Built-in Voice Message is left at the same time, "Voice Message" will be displayed (for DPT with display user only). Refer to 2.6.1 Built-in Voice Message.

◆ **To call back**

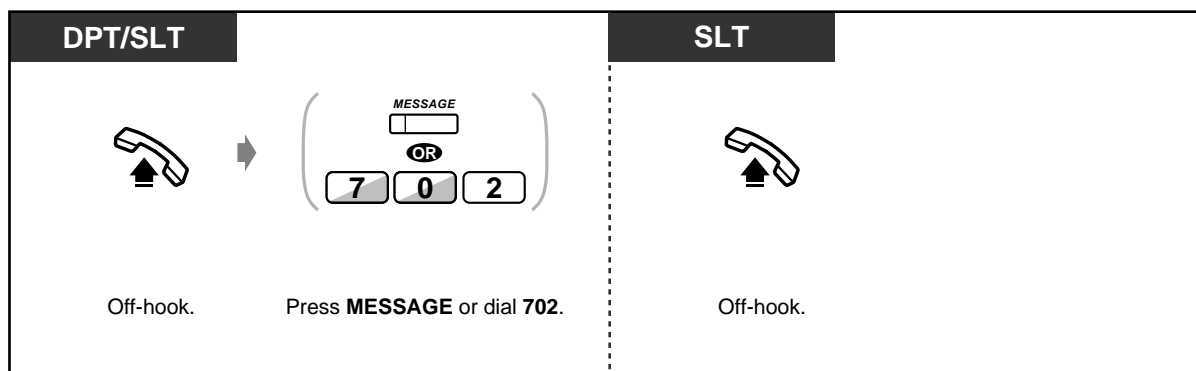

- SLT users can change the call back operation style by system programming (default: off-hook and dial 702). Consult your dealer.
- Dial tone 4 will be heard when going off-hook.



- If the indication for the Built-in Voice Message is left at the same time, you will hear dial tone 5 when going off-hook. Pressing the MESSAGE button enables you to replay newly stored voice messages in the order of arrival. Refer to 2.6.1 Built-in Voice Message.



- If the rest of recording time for the Built-in Voice Message feature becomes less than 5 minutes, dial tone 6 will be heard when going off-hook.

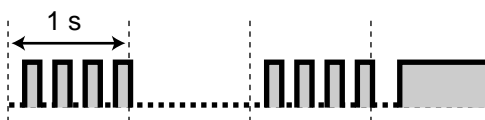

◆ **To clear all message waiting indications**

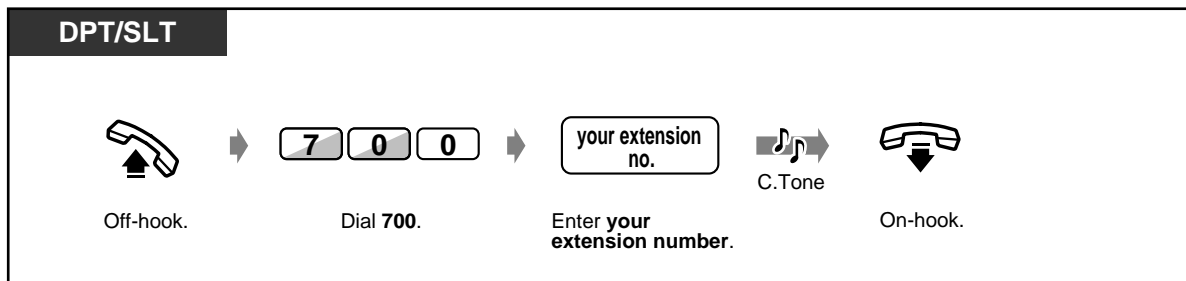

Customising Your Phone

- 4.1.3 Customising the Buttons
Create or rearrange a MESSAGE button.

◆◆ **Joining an existing call (Executive Busy Override)**

You can call the party who is talking with another on the telephone or add a third party to your existing conversation.

◆ **To join**

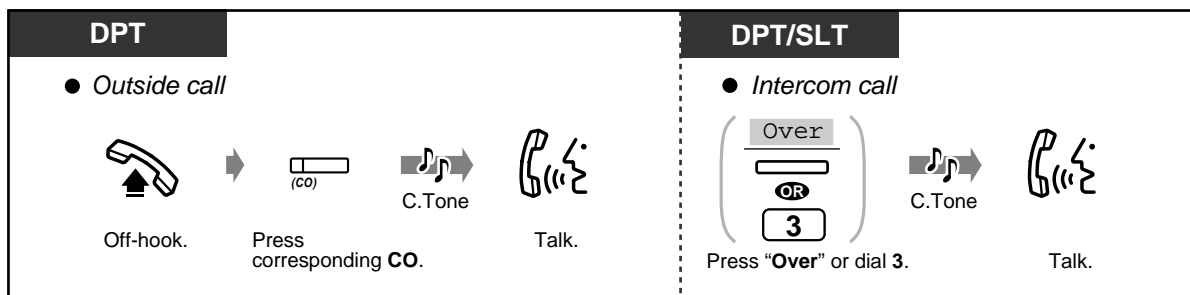

◆ **To disconnect one party and talk with another when one of these parties is an outside call**

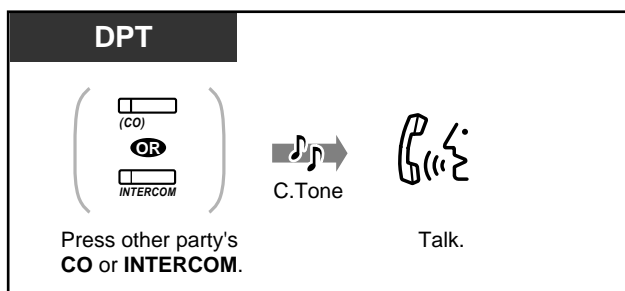

- You can also deny others the possibility of joining your conversation (Default: Allow). Refer to "2.8.9 Denying Other People the Possibility of Joining Your Conversation (Executive Busy Override Deny)".

2.2.5 Calling without Restrictions

— Using an account code

— To an extension refusing the call

◆◆ Using an account code (Account Code Entry)

An Account Code gives information about outside calls for accounting and billing purposes. You may not be able to make an outside call without an account code entry. A mode is assigned to each user. Ask your manager for your mode.

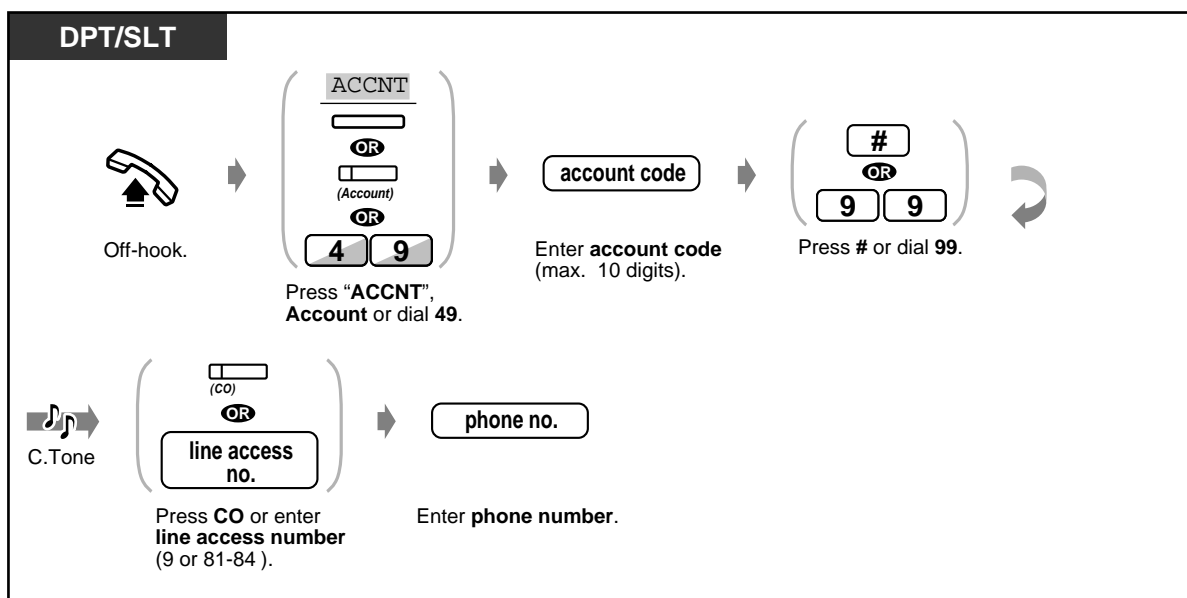

- **A Panasonic digital proprietary telephone user** can enter an account code during a conversation or when hearing a reorder tone after the other party hangs up.
- **If you enter the wrong code**, press the "*" key while entering the account code and then re-enter the code.
- **To cancel the entry**, press the Account button while entering the code.
- **For your convenience**, you can store the code with the phone number in memory (e.g. Speed dialling).
- **If you hear a reorder tone**, the entered account code is wrong. Enter the correct code.



- You may give a specified account code to extension users and check their telephone usage. You can specify an account code to each client and check the call duration.



Customising Your Phone

- 4.1.3 Customising the Buttons
Create or re-arrange an Account button.

◆◆ **To an extension refusing the call (DND Override)**

DPT/SLT

While hearing the DND tone

Over

OR

2

Press "Over" or dial 2.

2.2.6 Changing the Mode

- Alternating the calling method
- Changing the dialling mode from pulse to tone

◆◆ Alternating the Calling Method (Alternate Calling — Ring/Voice)

The calling method, either ring or voice, is set by the called extension when an intercom call is received. However, you can change the method temporarily.

Ring-calling (Default):

You can call the other party with a ring.

Voice-calling:

You can talk to the other party immediately after a confirmation tone.

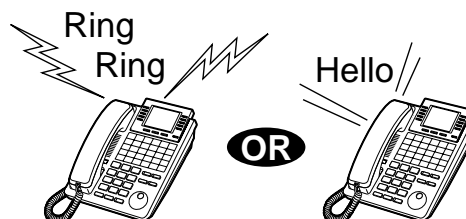

◆ For voice-calling

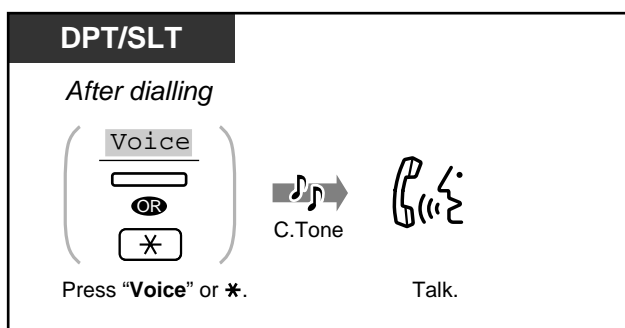

◆ For ring-calling

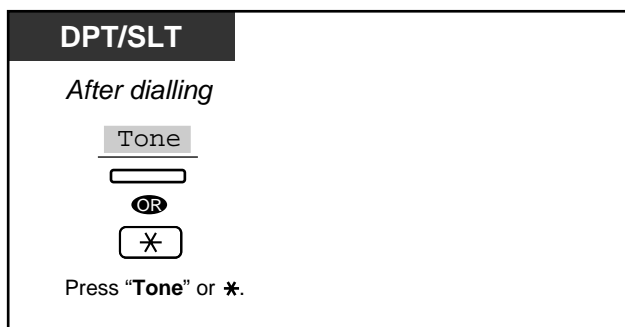

- If the called party uses a single line telephone, only Ring-Calling is available.
- You can switch the desired calling method only once during a call.



Customising Your Phone

- 4.1.2 Initial Settings—Intercom Alert Assignment
Which way do you prefer to receive an intercom call?

◆◆ **Changing the dialling mode from pulse to tone (Pulse to Tone Conversion)**

To access services such as computer telephone services, Voice Mail, etc., that require a tone, you can temporarily change the dialling mode from Pulse to Tone.

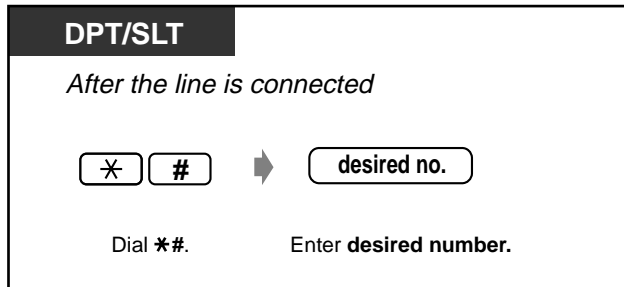

2.2.7 Integrated Services Digital Network (ISDN) Service Access

You can reach the ISDN Key Pad Protocol Service from your extension. The service depends on the contract with your telephone company.

◆ If your telephone has an ISDN SERVICE button

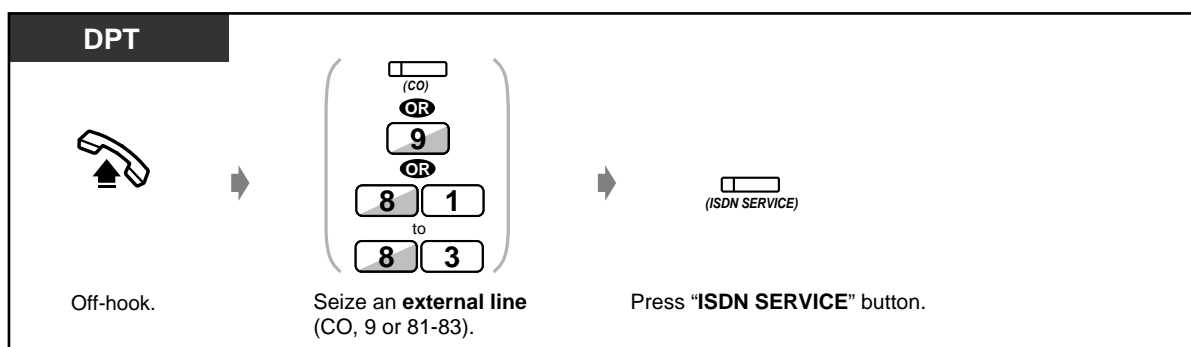

◆ If your telephone does not have an ISDN SERVICE button

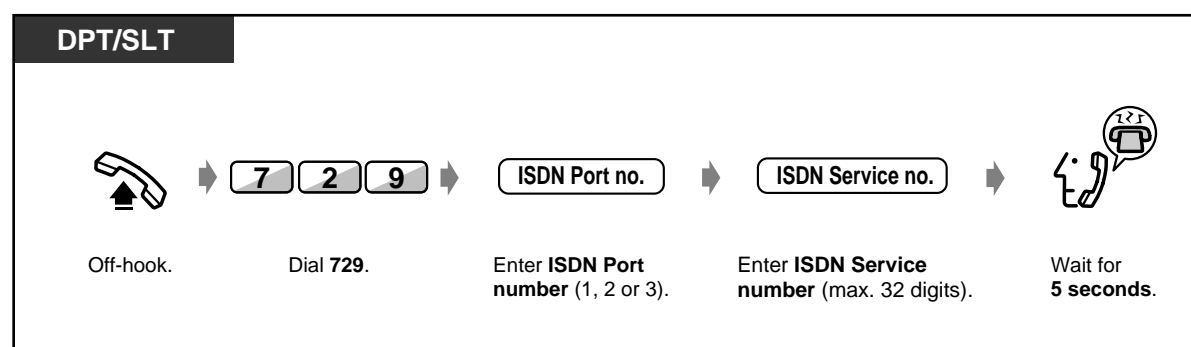
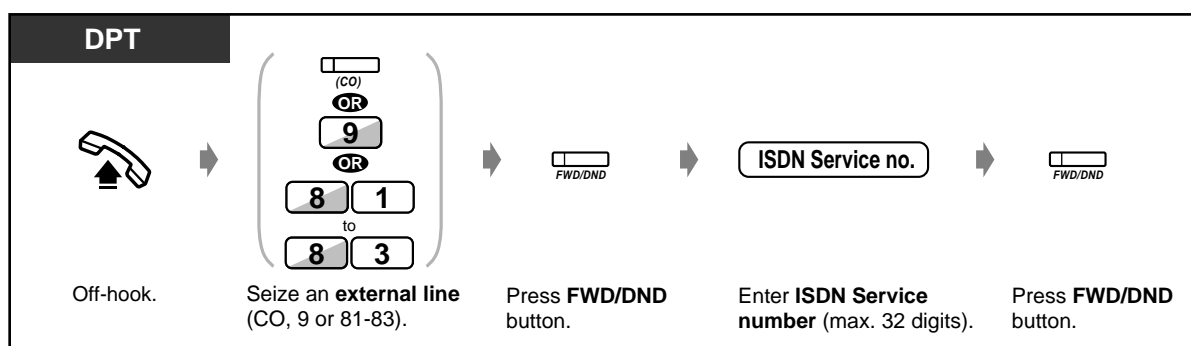

- At the end of the procedure, a voice prompt tells you that the acceptance of the service is completed depending on each Integrated Digital Services Network.



Customising Your Phone

- 4.1.3 Customising the Buttons
Create or re-arrange an ISDN SERVICE button.

2.2.8 To Access Another Party Directly from Outside (Direct Inward System Access [DISA])

This feature is possible if an optional card KX-TD61291 is installed in the main unit. This feature allows an outside caller to access specific system features as if the caller is an extension in the system. The caller can have direct access to features below.

— Placing an incoming call to extensions such as (1) Extension (2) ISDN extension (3) Hunting Group (4) Phantom extension (5) External pager (for Trunk Answer From Any Station [TAFAS]) (6) Voice Mail extension. The caller also has the option of dialling the route for an extension using 1 digit number (DISA Automated Attendant (AA) number) via DISA calls.

— Calling an external party.

— Setting or cancelling the "Call Forwarding — to CO Line, All Calls" feature.

— Call forward to outside line ("Call Forwarding — to CO Line, All Calls" and "Call Forwarding — to CO Line, No Answer") in accordance with pre-selected CLIP and DDI/MSN numbers.

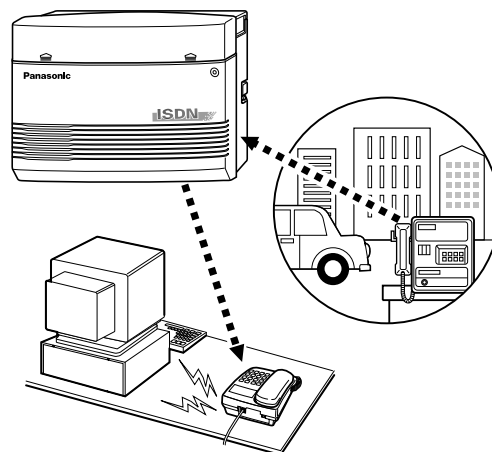

An outgoing message (OGM) greets the caller and gives information about how to access an extension. You do not need the operator's assistance.

You may not be able to access the features without a DISA user code depending on the security mode.

Non Security Mode: Any caller can make outside or intercom calls.

Trunk Security Mode (Default): A pre-assigned DISA security code must be entered to make outside calls.

All Security Mode: A pre-assigned DISA security code must be entered to make both outside and intercom calls.

This prevents the caller from making unauthorised calls. However, when making an outside call by Call Forwarding – to Outside (CO) Line, the call is allowed (exception). Ask your manager for the mode assigned to your system.



- An optional voice message card KX-TD61291 is required to enable DISA function.
- This feature is available only for DTMF (Touch Tone) telephone user.
- The outside-outside line call is only available when the DISA call is made with an ISDN line. However, when calling to an external party by the Call Forwarding — to CO Line feature, the call is allowed exceptionally even if the DISA call is made with an analogue CO line.

WARNING

When you enable the Outside-Outside Line Call feature of DISA function, if a third party discovers the password (a DISA User Code) of the system, you have a risk that they will make illegal phone calls using your telephone line, and the cost may be charged to your account.

To prevent this problem from occurring, we strongly recommend the following points:

- 1: Carefully maintain the secrecy of the password.
- 2: Specify a complicated password with several digits.
- 3: Change the password frequently (at least once per month).

Note

- Be sure to assign Intelligent Call Handling table beforehand. Otherwise, outside callers cannot access DISA. (Refer to 4.2.3 System Speed Dialling and Intelligent Call Handling Number Set (001)) Consult your manager for a detailed assignment.

◆◆ Calling an extension

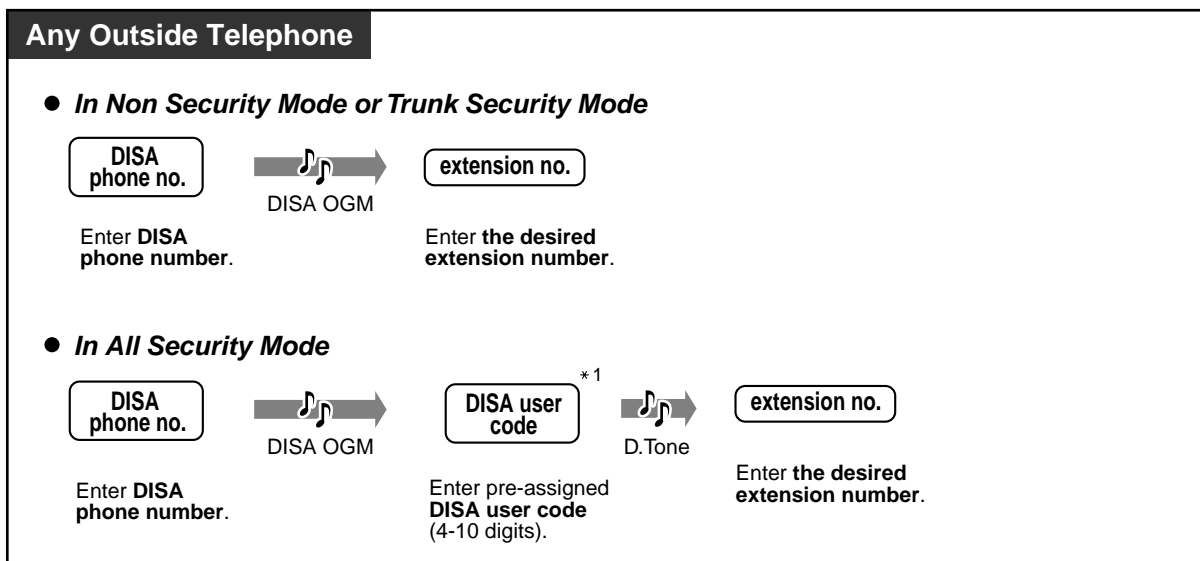

◆◆ Calling an external party

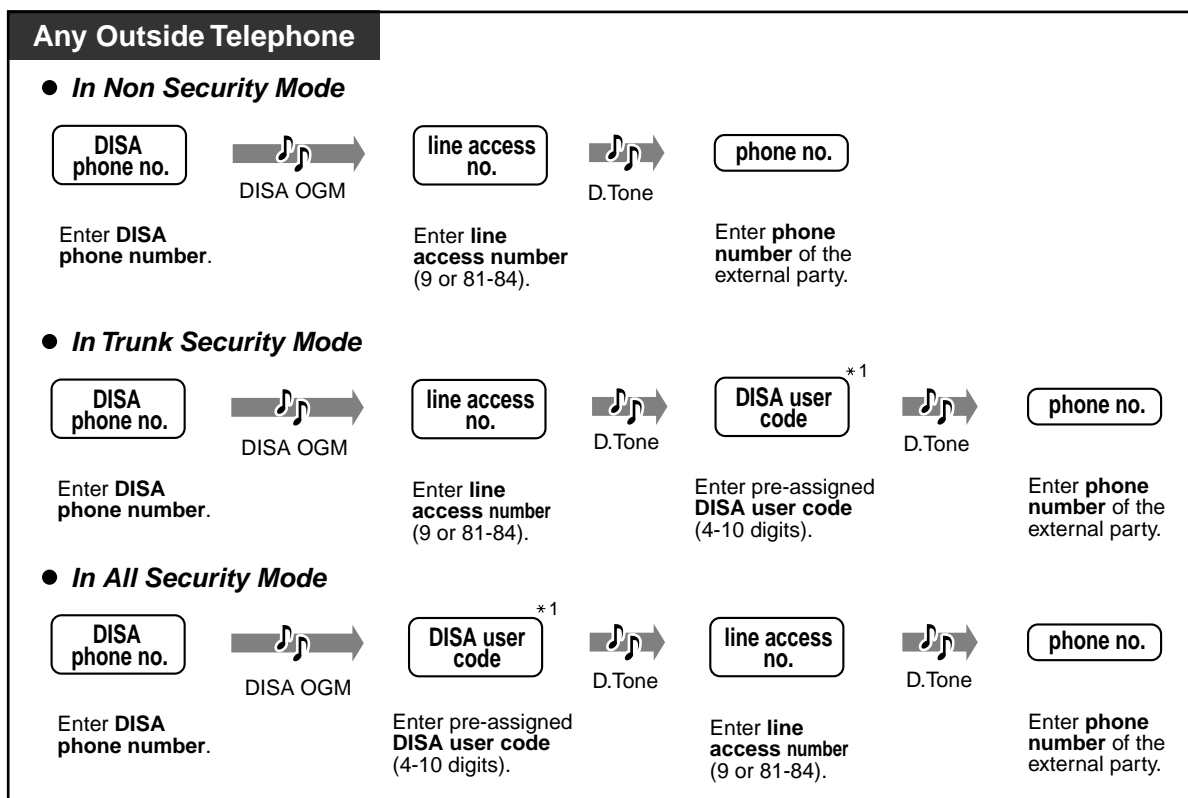

- *1: If you dial a wrong DISA user code, dial * and try again from this point.
- If you enter a wrong DISA user code 3 times, the line will be disconnected automatically.
- In case a destination of Intercept Routing is not assigned, the call which was made by DISA function will be disconnected automatically when it is over a programmed time period.
- **If Built-in Automated Attendant service is set**, you can access the desired extension simply by pressing 1 digit number (0-9) according to the outgoing message.
- You can select either to direct a call to the pre-programmed Intercept Routing destination or to disconnect it without respect to the pre-programmed Intercept Routing destination (default: direct the call to the pre-programmed Intercept Routing destination) when a caller dials nothing for the pre-determined period of time (default: 5 s later) after hearing DISA OGM. System Programming is required. Consult your dealer.

◆ **To start a new conversation**

Any Outside Telephone

To dial a different number during a conversation with an outside party or while hearing the ringback, reorder, or busy tone

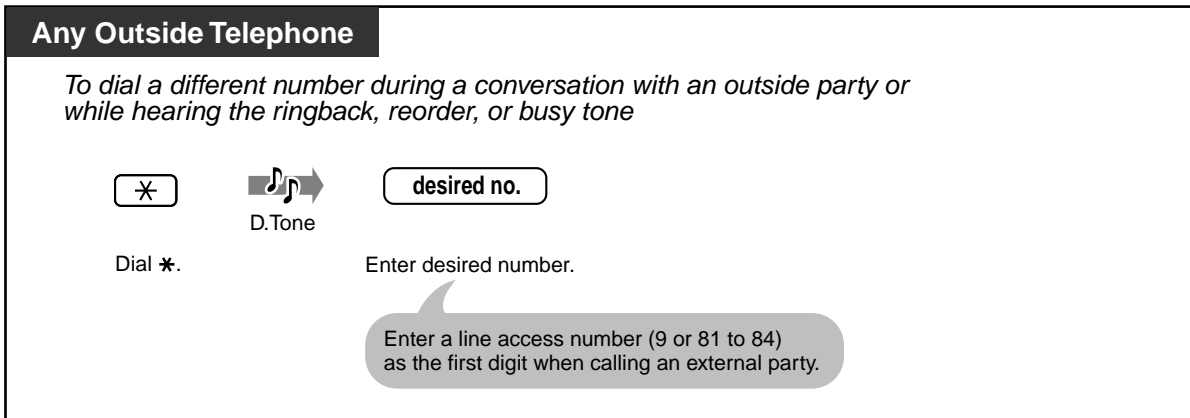

Enter a line access number (9 or 81 to 84) as the first digit when calling an external party.

◆◆ **Setting or cancelling the "Call Forwarding to CO Line, All Calls" feature**

◆ **To set**

Any Outside Telephone

- **In Non Security Mode or Trunk Security Mode**

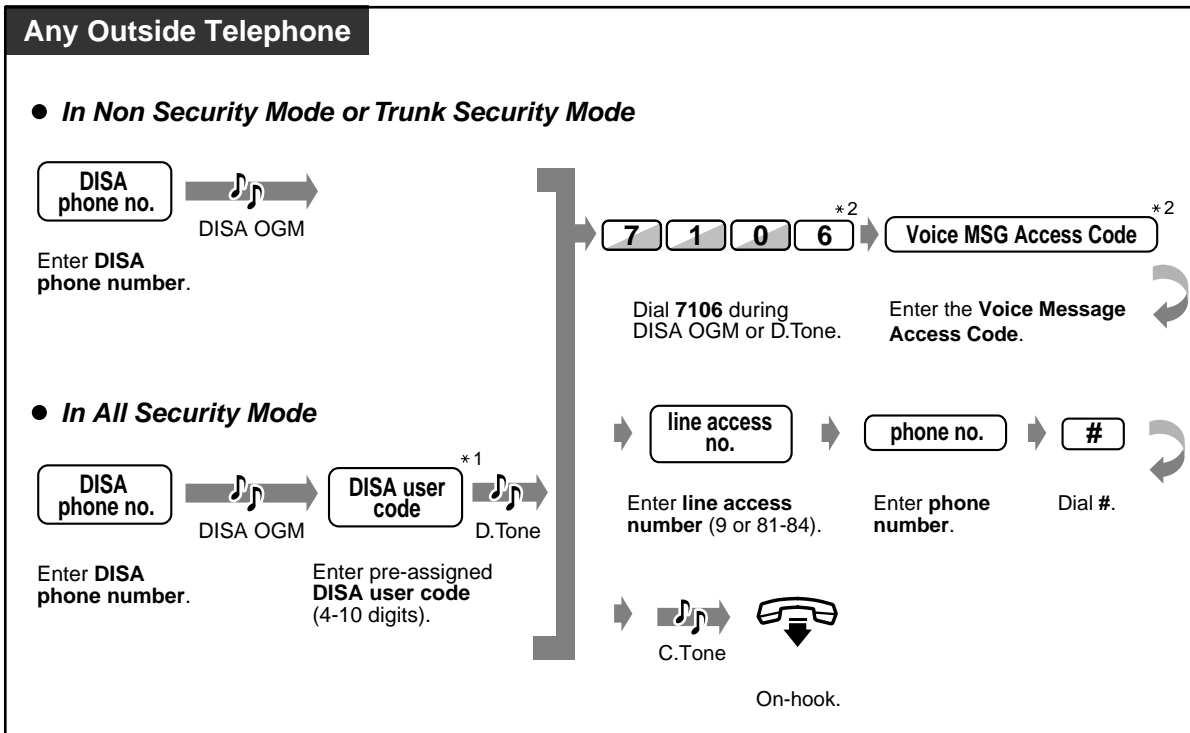

Enter DISA phone number.

Dial 7106 during DISA OGM or D.Tone.

Enter the Voice Message Access Code.

- **In All Security Mode**

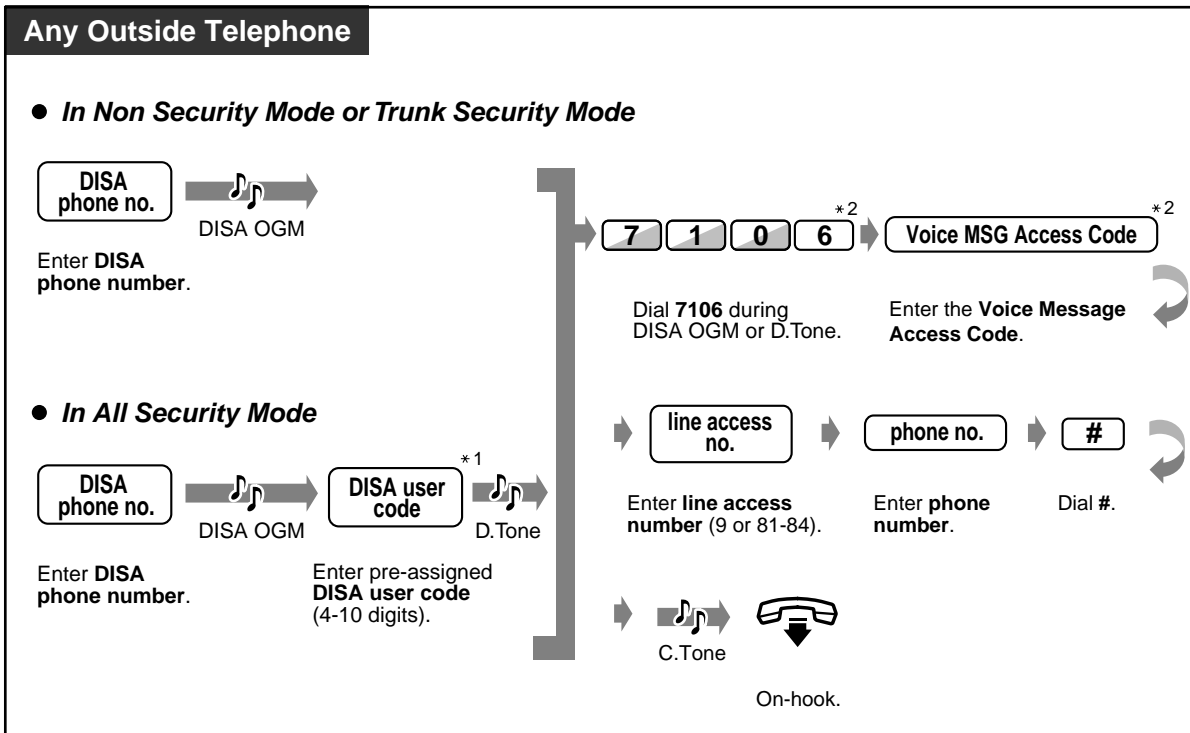

Enter DISA phone number.

Enter pre-assigned DISA user code (4-10 digits).

Enter line access number (9 or 81-84).

Enter phone number.

Dial #.

C.Tone

On-hook.

◆ **To cancel**

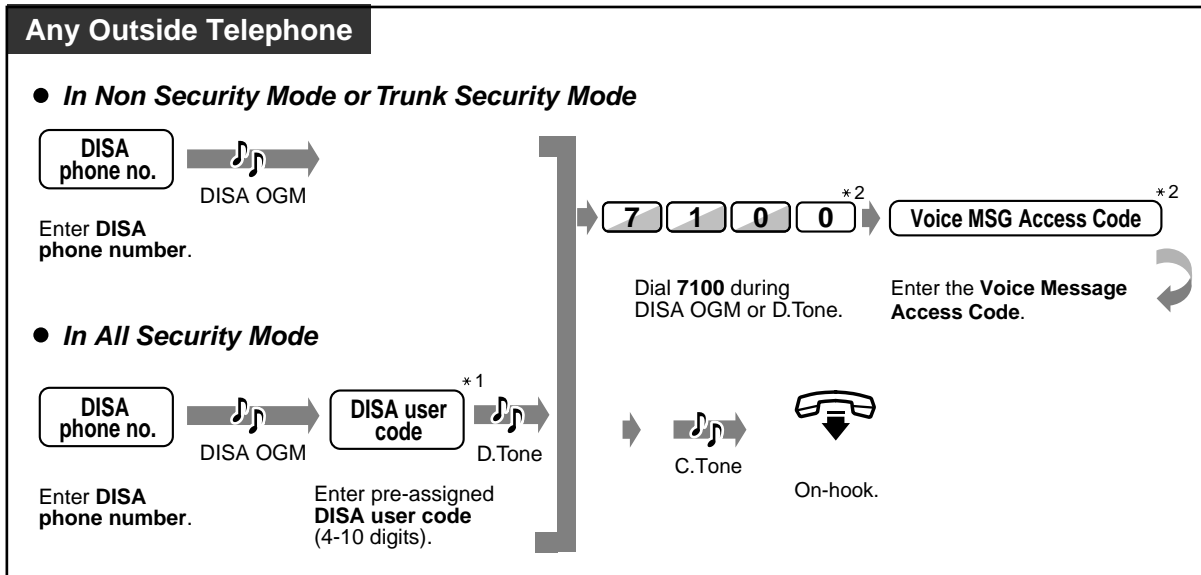

◆◆ **Call forward to outside line ("Call Forwarding to CO Line, All Calls" and "Call Forwarding to CO Line, No Answer") in accordance with pre-selected CLIP and DDI/MSN numbers**

◆ **To store a pre-selected CLIP or DDI/MSN number**

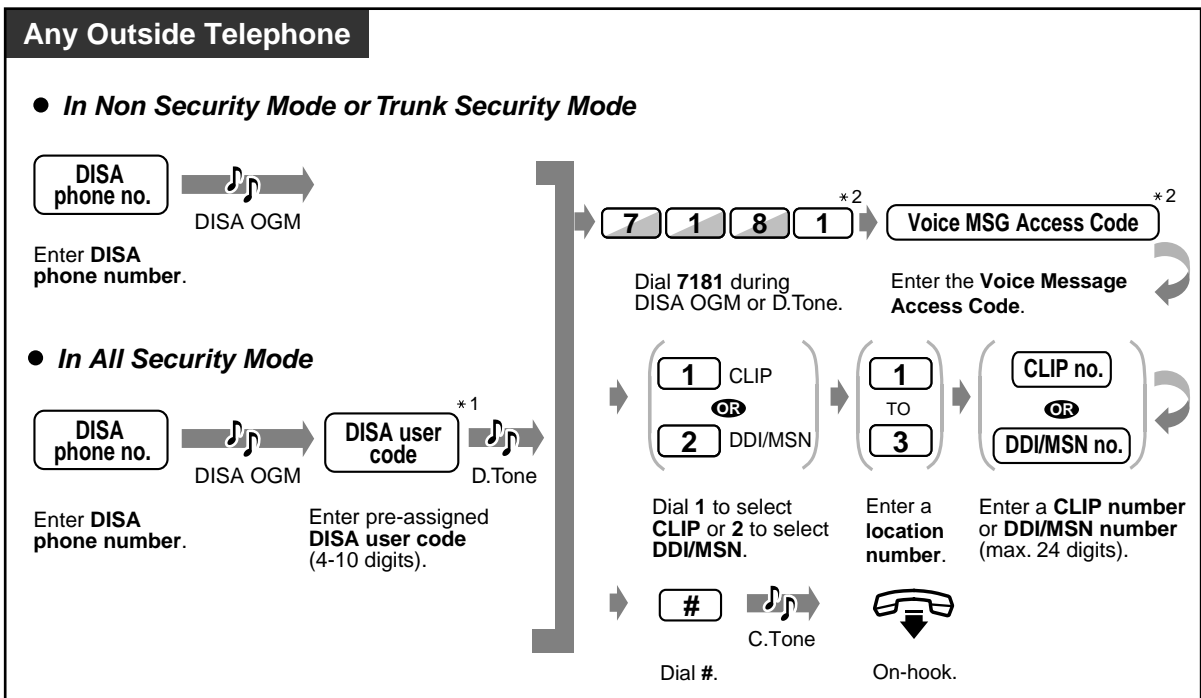

◆ **To delete a pre-selected CLIP or DDIMS number**

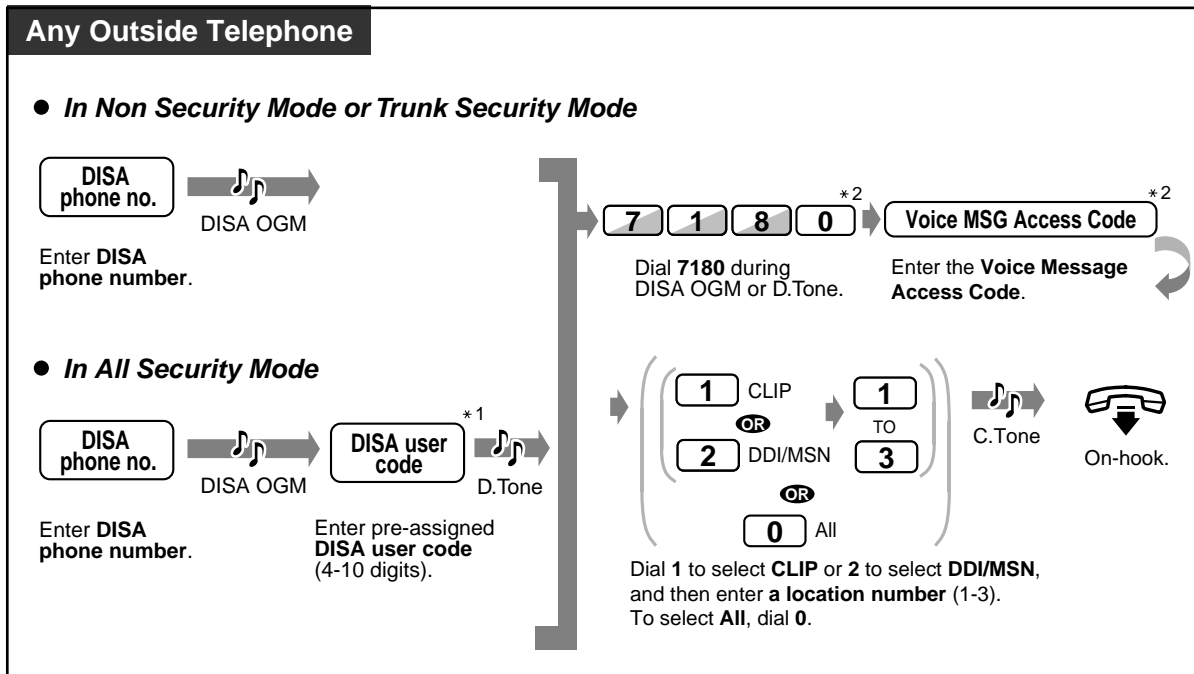

◆ **To activate a pre-selected CLIP or DDIMS number**

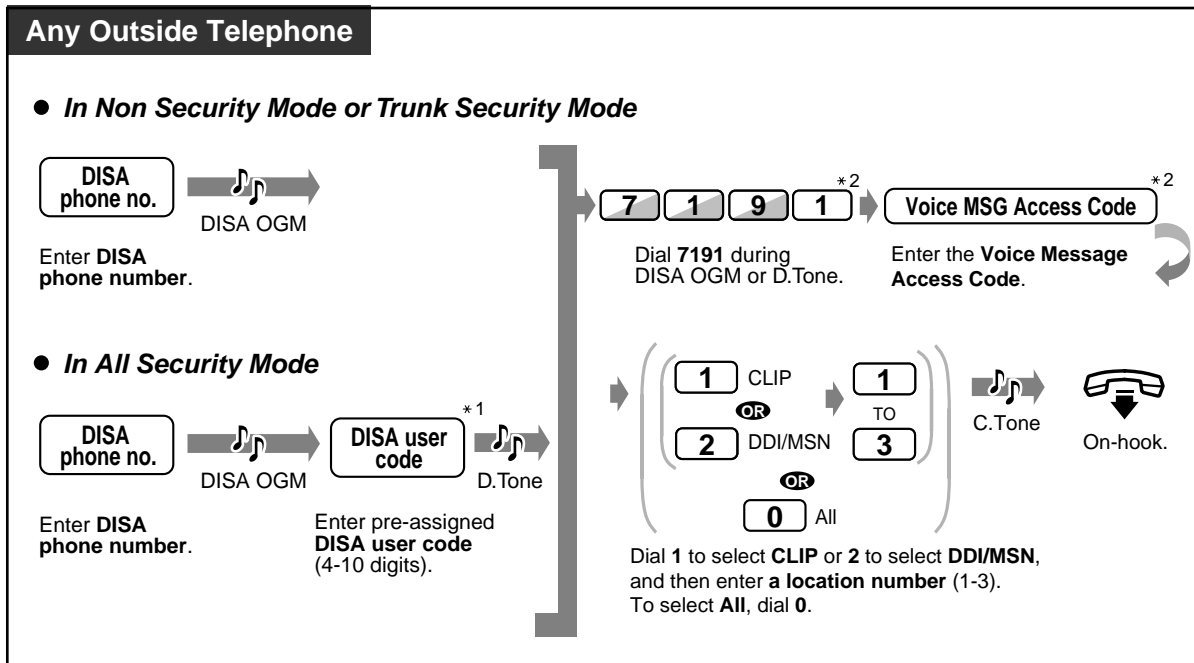

◆ To cancel an activation of a pre-selected CLIP or DDI/MSN number

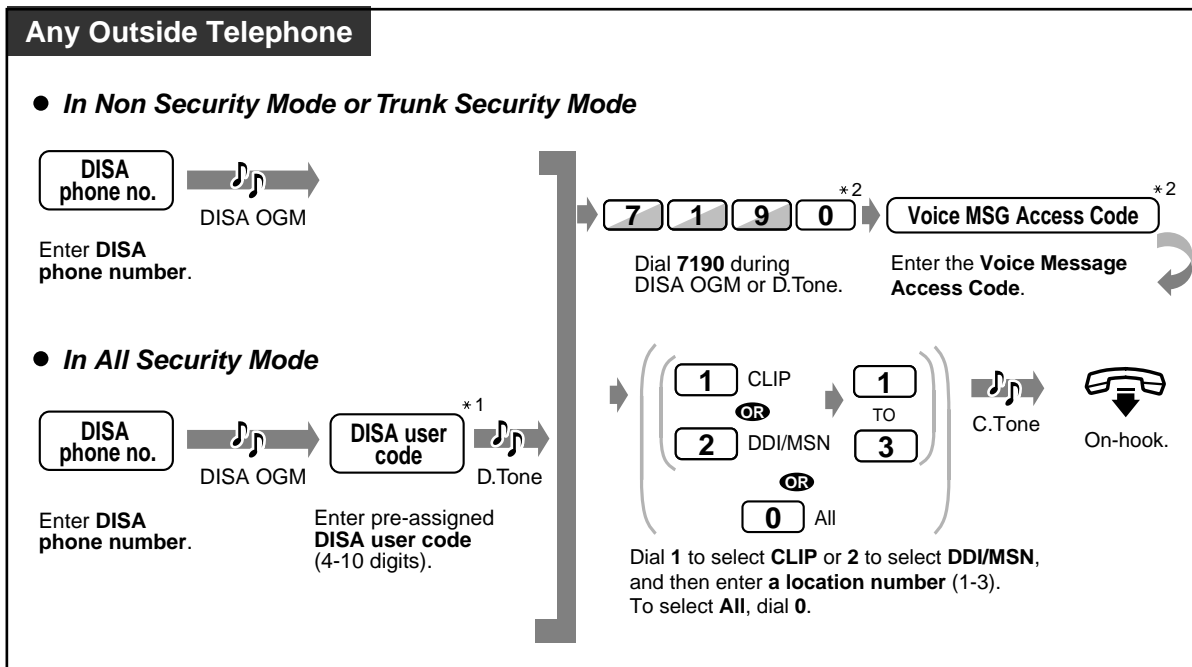

- *1: If you dialled a wrong DISA user code, dial * and try again.
- *2: You can re-try by dialling * when you dialled a wrong feature number or voice message access code. System Programming is required. Consult your dealer.
- These settings can be performed regardless of the type of DISA security mode.
- Even though you cancel the forwarding destination, this operation cancels the "Call Forwarding — to CO Line, All Calls" feature only. Any other Call Forwarding features and Do Not Disturb (DND) will not be cancelled.

2.3 Receiving Calls

2.3.1 Answering Calls

DPT/SLT



Off-hook.

→



Talk.

Select one of the following methods:

- Lift the handset to receive the preferred line. (Default: Ringing line is selected.)
- Press the SP-PHONE or MONITOR* button.
- Press the flashing CO or green INTERCOM button directly.



* **When going off-hook using the MONITOR button**, you have to lift the handset to talk to the other party.



• **Hands-free operation**

You can have a conversation in the hands-free mode with the SP-PHONE button. You can perform other tasks at the same time.

Helpful hints for the hands-free operation

Use your telephone in a quiet room for best performance.

If the other party has difficulty hearing you, decrease the volume.

If you and the other party talk at the same time, parts of your conversation will be lost. To avoid this, talk alternately.

- **If the Incoming Call Log feature is available**, you may confirm the caller's phone number and name before answering an outside call.

Pressing the SHIFT button or "X" displays the outside line number and either the outside line name or the name of the DDI/MSN number.

<Example>

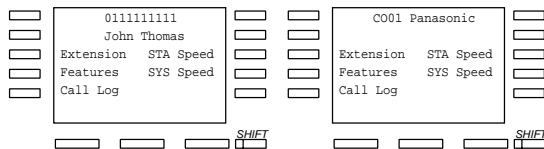

The caller's information from your telephone company will only be sent to the pre-assigned extension.

- If a DDI/CLIP key is assigned to a flexible button on your digital proprietary telephone (DPT), the LED indicator of the key flashes green when receiving a call from the CLIP number, or with the DDI/MSN number, you assigned at System Speed Dialling and Intelligent Call Handling table. You can answer the call by pressing the flashing DDI/CLIP key.



Customising Your Phone

- 4.1.2 Initial Settings —
 - **Preferred Line Assignment — Incoming**
Select the seized line when going off hook.
 - **Intercom Alert Assignment**
Select the Calling method, either ring or the other party's voice.
- 4.1.3 Customising the Buttons
Create or re-arrange a CO button or a DDI/CLIP key, and change the ringing tone for each CO button.

2.3.2 Answering Hands-free (Hands-free Answerback)

You can answer an intercom call without going off-hook as soon as the line is connected. You will hear the caller talking without the phone ringing.



◆ To set/cancel

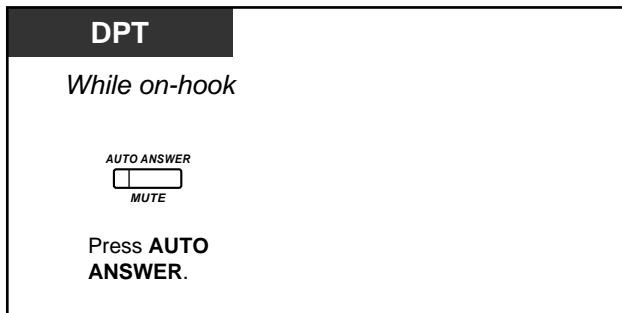

- The AUTO ANSWER button light shows the current status as follows:
On: Set.
Off: Not set.

2.3.3 Answering a Call Ringing at Another Telephone (Call Pickup)

You can answer an incoming call that is ringing at another extension from your phone without leaving your desk.

Extension Group

An extension group is used for group paging and group pickup features. An extension can belong to several extension groups.

The following types are available:

Outside (CO) Call Pickup: Picks up an outside call.

Group Call Pickup: Picks up a call within your extension group.

Directed Call Pickup: Picks up a specified extension's call.

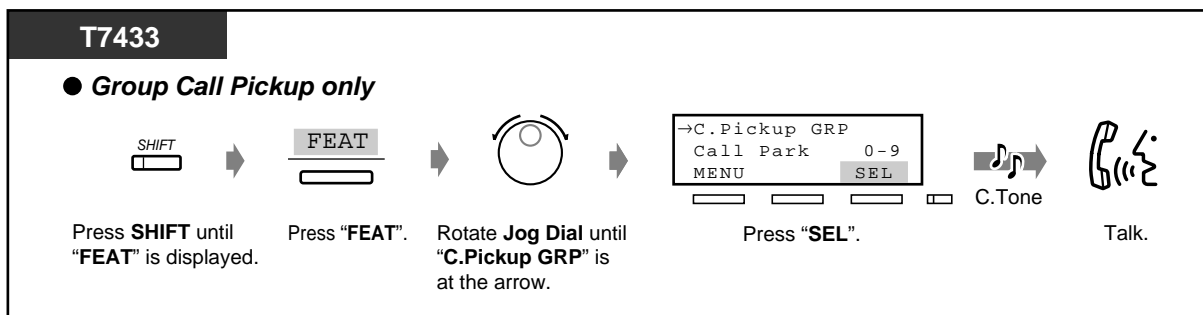
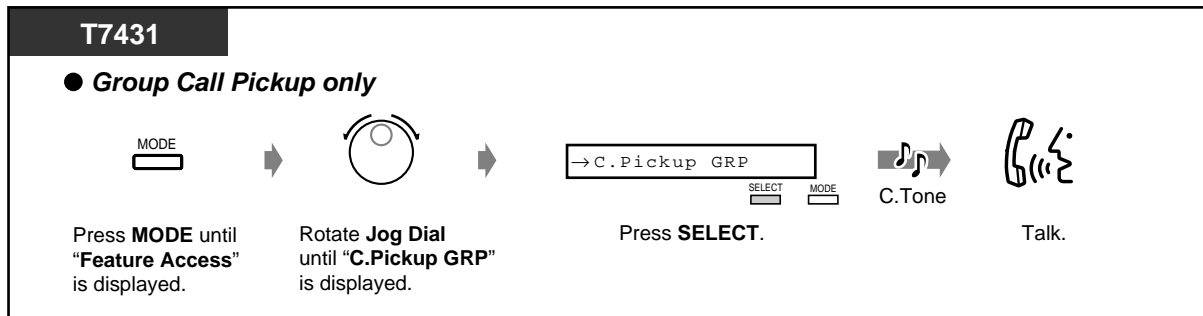
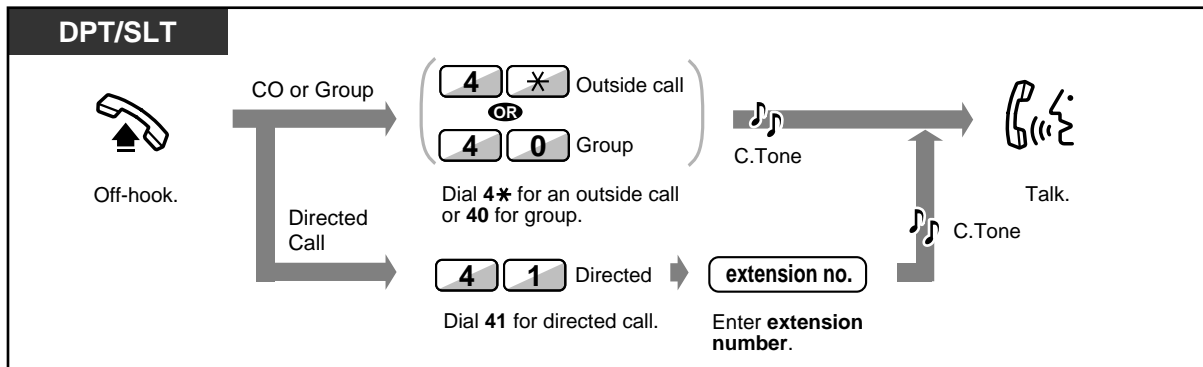

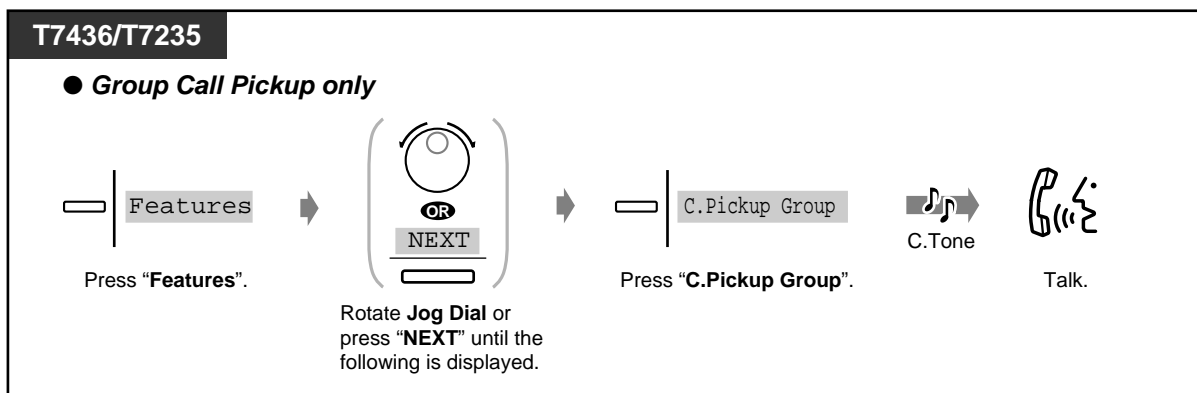

- **If you receive a call waiting tone**, you can ask a third party to pick up your second call with Directed Call Pickup.



- You can also deny other people the possibility of picking up your calls. Refer to 2.8 Setting the Telephone According to Your Needs.

2.3.4 Answering a Call via an External Speaker (Trunk Answer From Any Station [TAFAS])

You can answer an incoming outside call paged through an external speaker from any extension.

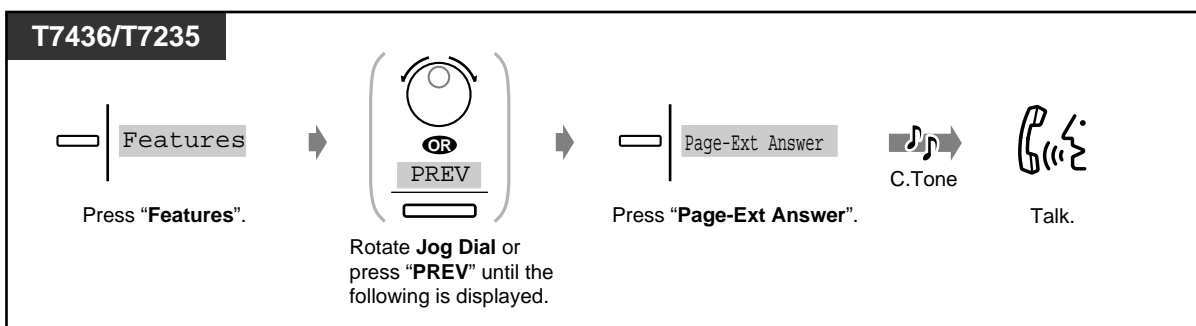
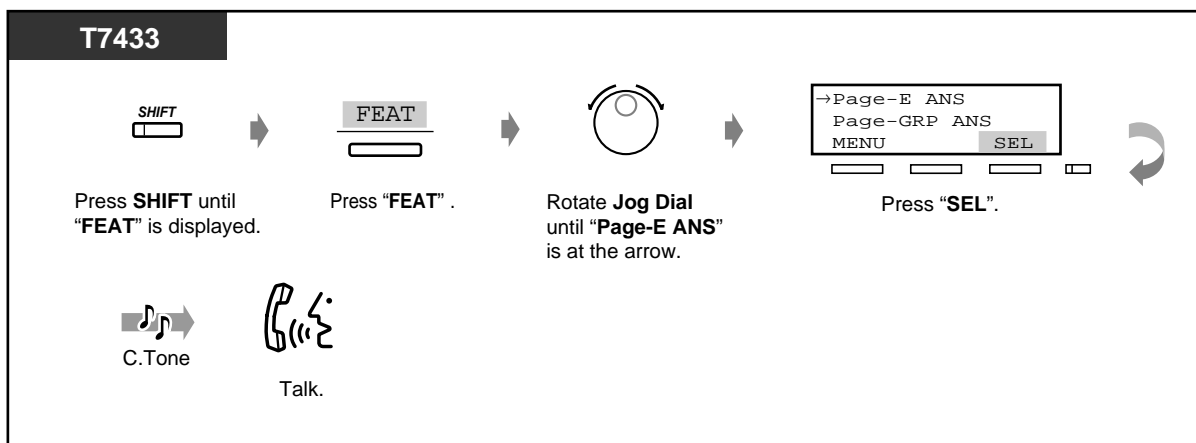
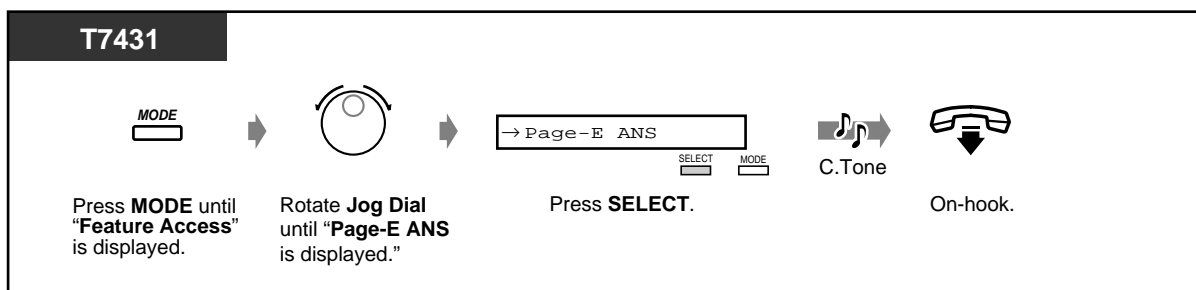
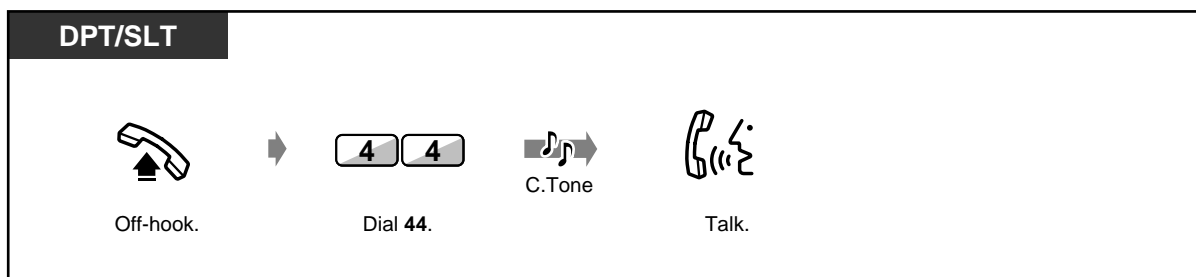



- You can also receive a paged announcement via a speaker with this operation.

2.3.5 Deflecting a Call (Call Deflection)

This is only available for the DPT with display which has more than two lines. If, for example, you cannot answer the call because you are so busy, you can transfer the call you are currently receiving to your personal message box (Built-in Voice Message) or your mail box (Voice Processing System).



◆ To deflect a call to your personal message box

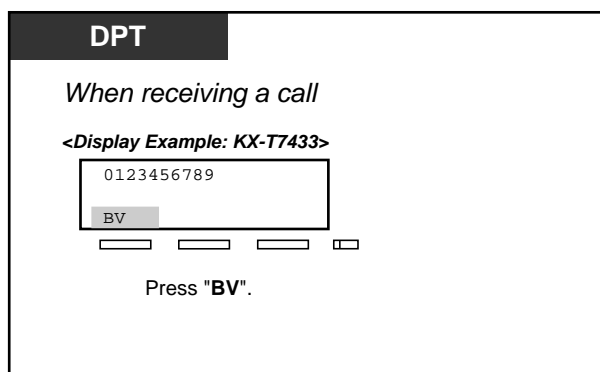

- If a call cannot be deflected because the voice message resource is busy, "BV . BOX Busy" will be displayed for 3 seconds.
- If a call cannot be deflected because the voice message resource is full, "Voice Msg Full" will be displayed for 3 seconds.
- If the OGM for your personal message box has not been stored, you cannot deflect the call.
- If you have set Call Forwarding — No Answer, "EXT" will be displayed at the bottom line. **To forward the call to the destination extension, press "EXT".**
- If you have set Call Forwarding — to CO Line, No Answer, "CO" will be displayed at the bottom line. **To forward the call to the destination, press "CO".** Availability of this feature depends on the ISDN service of your telephone company.
- This feature is not available for Intelligent Call Handling 1:N calls.

◆ To deflect a call to your mailbox

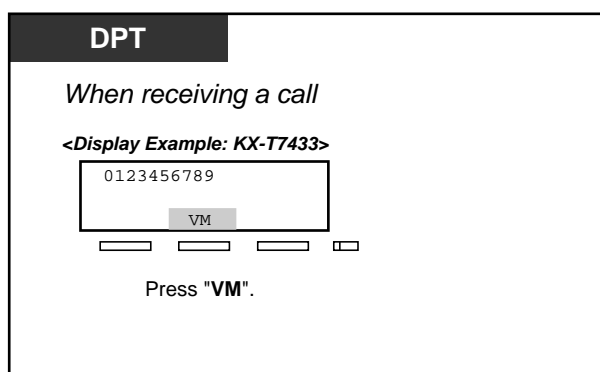



- If a call cannot be transferred because the voice mail resource is busy, "265: Busy" will be displayed for 3 seconds. ("265" is the example of your voice mail extension number.)
- System programming is required. Ask your dealer.
- If you have set Call Forwarding — No Answer, "EXT" will be displayed at the bottom line. **To forward the call to the destination extension**, press "EXT".
- If you have set Call Forwarding — to CO Line, No Answer, "CO" will be displayed at the bottom line. **To forward the call to the destination**, press "CO". Availability of this feature depends on the ISDN service of your telephone company.
- This feature is not available for Intelligent Call Handling 1:N calls.

2.4 During a Conversation

2.4.1 Call Duration

You can see the call duration during the conversation.

◆ **To view the call duration***

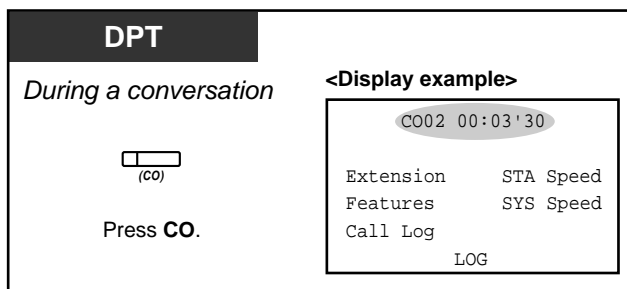

- * A digital proprietary telephone users may change the displayed message as follows by pressing the CO button.

<KX-T7230>



<KX-T7433/KX-T7436/KX-T7235>

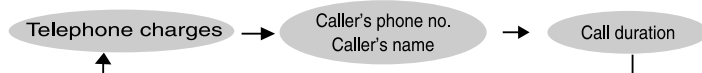

2.4.2 Holding a Call

- Holding
- One-touch dialling with automatic hold
- Denying other people the possibility of retrieving your held calls
- Holding in a system parking zone



- If a call is not retrieved within a specified time, you will hear an alarm as a reminder.
- If a call is not retrieved within fifteen minutes, it is automatically disconnected.

◆◆ Holding (regular)

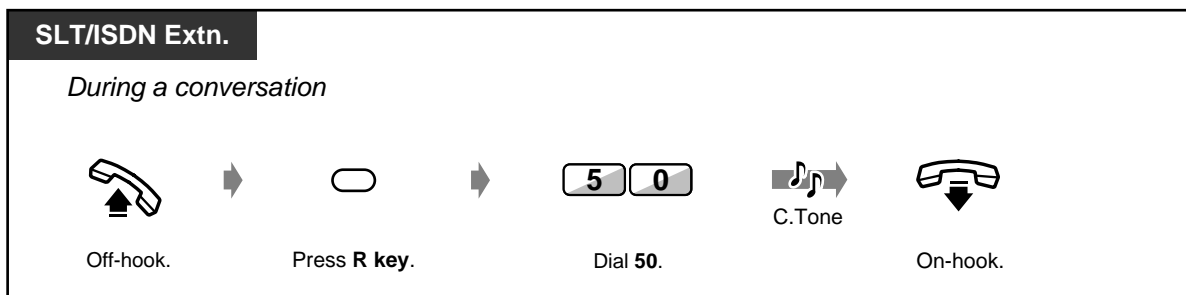
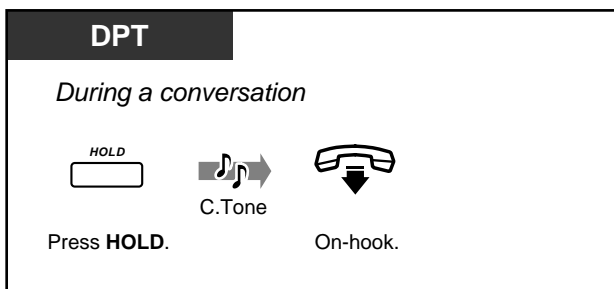



- If you hold a call at your ISDN extension, this can be cancelled at other ISDN extensions connected to the same ISDN extension port.

◆ To retrieve a call

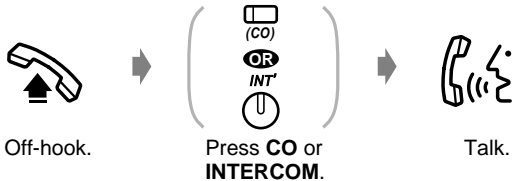
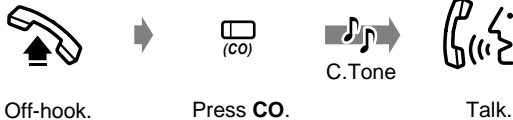
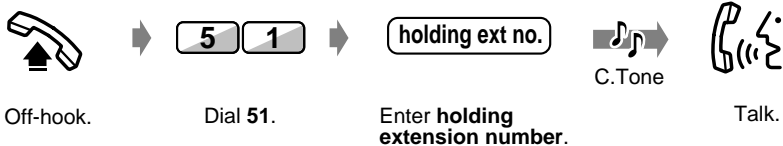
DPT

- **At the holding extension**

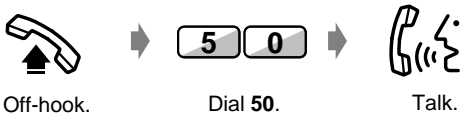
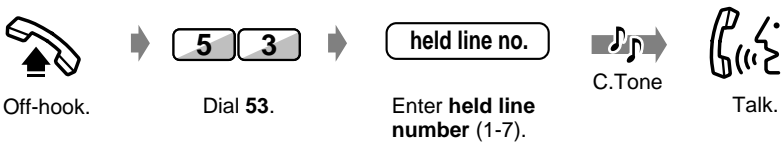
- **For an outside call from another extension**

- **For an intercom call from another extension**

SLT

- **At the holding extension**

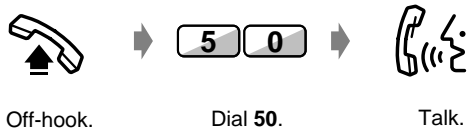
- **For an outside call from another extension**

- **For an intercom call from another extension**

ISDN Extn.

- **At the holding extension**



Off-hook. Dial 50. Talk.
- **For an outside call from another extension**



Off-hook. Dial 53. Enter **held line number** (1-7). C.Tone Talk.
- **For an intercom call from another extension**



Off-hook. Dial 51. Enter **holding extension number**. C.Tone Talk.



- The CO or INTERCOM button light shows the current status as follows:
 - Flashing green:** Your held call
 - Flashing red:** Another extension's held call
- A single line telephone user can hold either an intercom call or an outside call at one time.
- A digital proprietary telephone user can hold an intercom call and multiple outside calls.
- **To hold multiple intercom calls,** use the "Call Park" feature.

◆◆ **One-touch dialling with automatic hold**

You can dial to a third party with holding the present call.

DPT



(One-Touch Dialling with Auto Hold)

Press **One-Touch Dialling with Auto Hold**.



Customising Your Phone

- 4.1.3 Customising the Buttons
 - Create or re-arrange a One-Touch Dialling with Auto Hold button.

◆◆ **Denying other people the possibility of retrieving your held calls (Exclusive Call Hold)**

Only the held extension can retrieve the call.

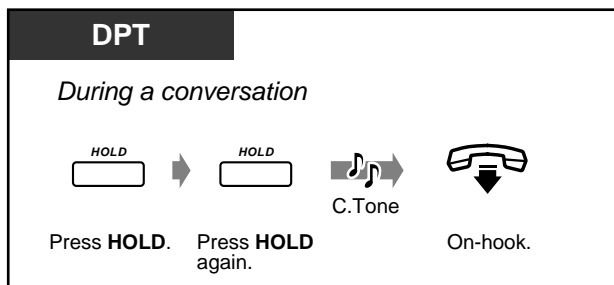

◆ **To retrieve a call**

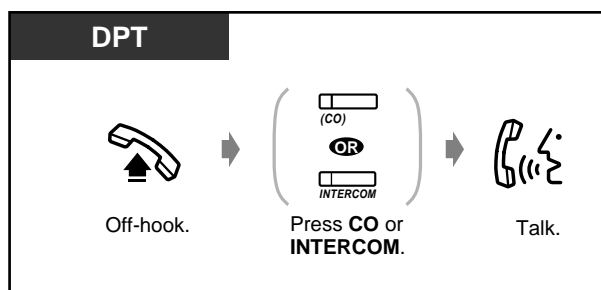

◆◆ **Holding in a system parking zone (Call Park)**

You can park a call and perform other operations. The parked call can be retrieved by any extension. Up to 10 calls can be parked.

◆ **To set**

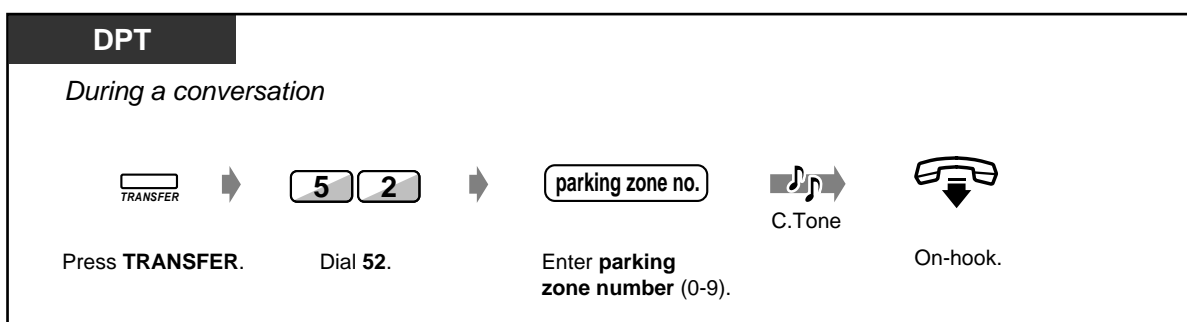

SLT

During a conversation

Press **Recall**. Dial **52**. Enter **parking zone number** (0-9). C.Tone On-hook.

T7431

During a conversation

Press **TRANSFER**. Press **MODE** until "Feature Access" is displayed. Rotate **Jog Dial** until "Call Park" is displayed. Press **SELECT**.

Enter **parking zone number** (0-9). C.Tone On-hook.

T7433

During a conversation

Press **TRANSFER**. Press **SHIFT** until "FEAT" is displayed. Press "FEAT". Rotate **Jog Dial** until "Call Park" is at the arrow.

Press "**SEL**". Enter **parking zone number** (0-9). C.Tone On-hook.

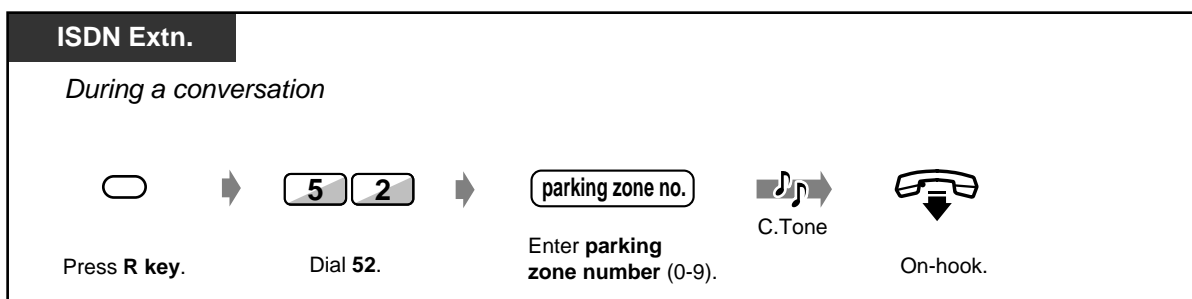
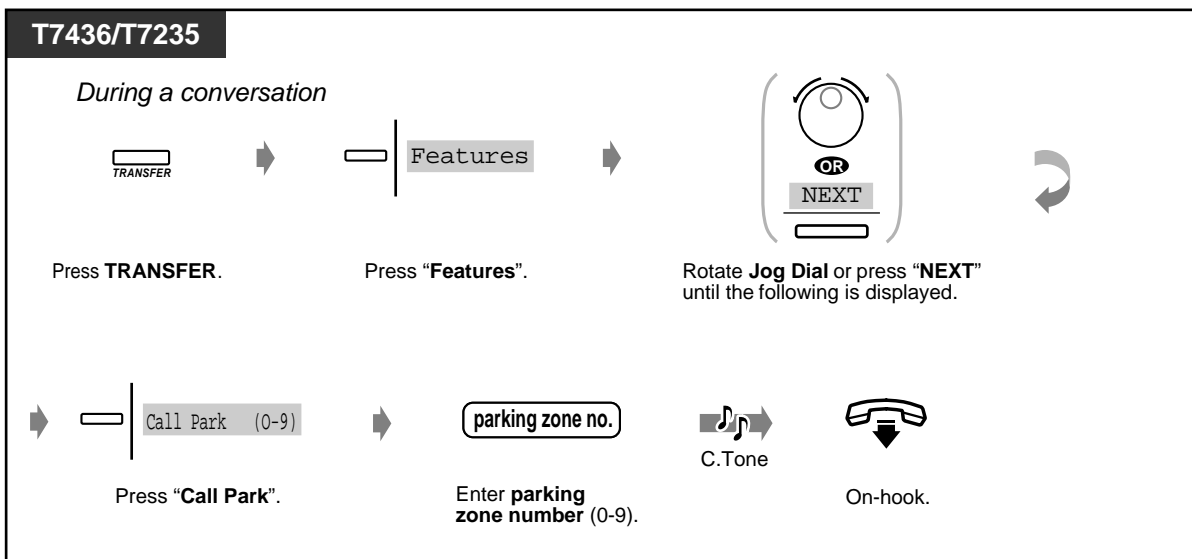

◆ **To retrieve**

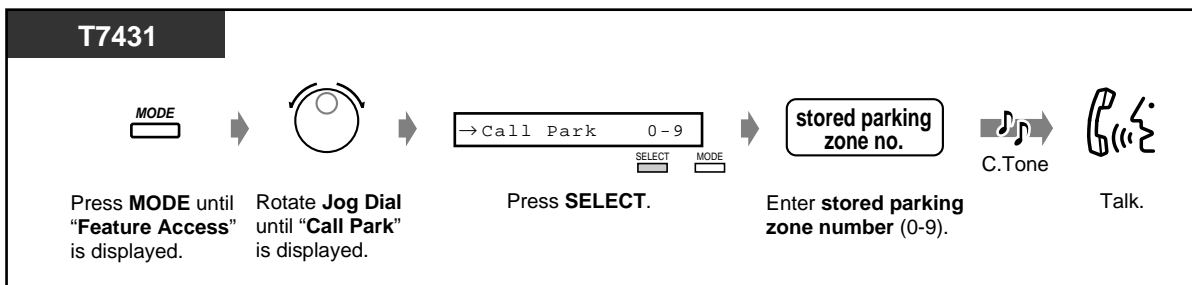
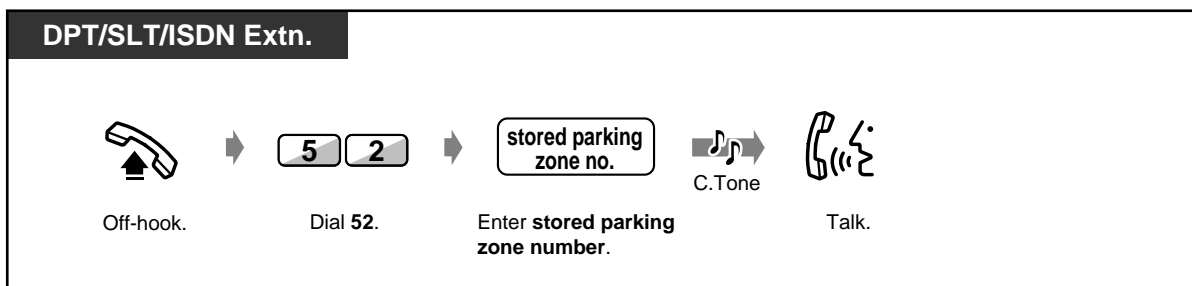

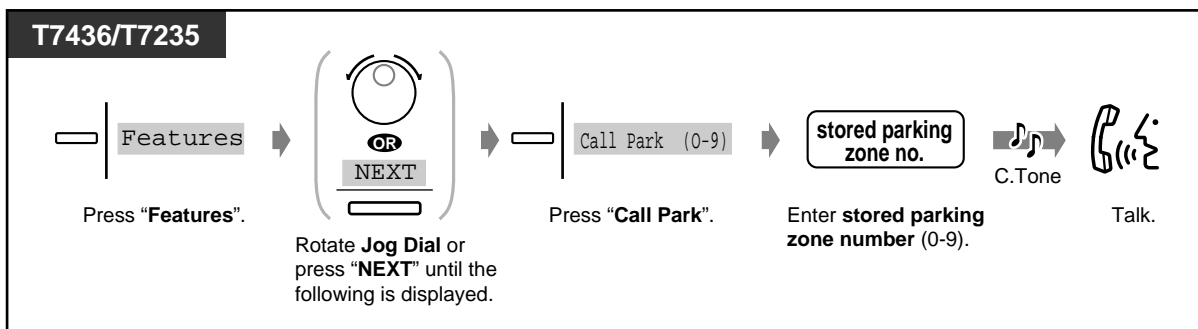
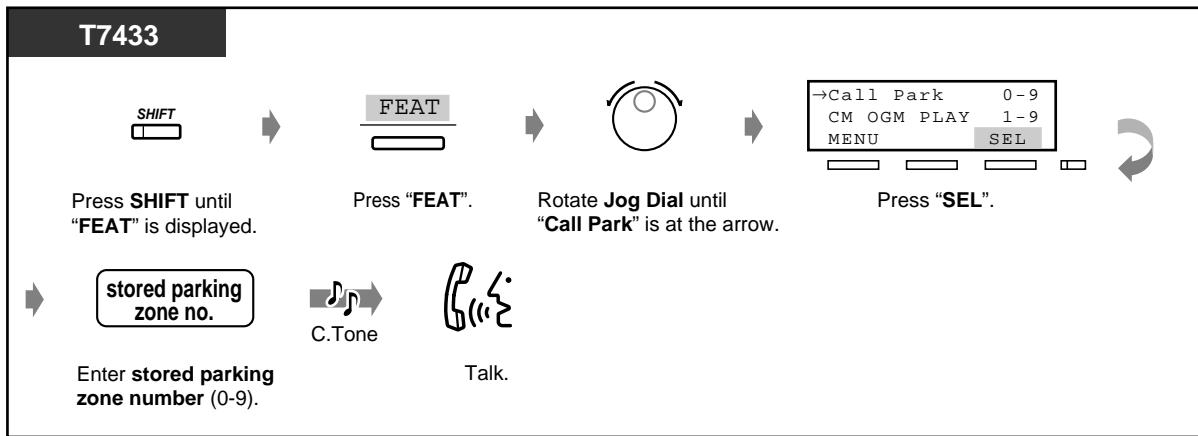

- **If you hear a busy tone when entering the zone number, the zone is in use. Enter another number.**

2.4.3 Retrieving a Call on a Telephone Answering Machine (TAM)

Retrieves a call on Telephone Answering Machine (TAM) regardless of the extension group.

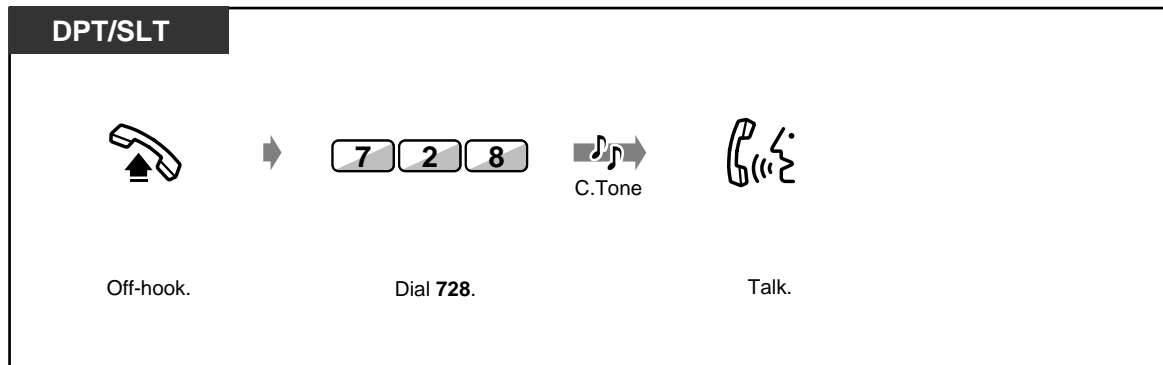

2.4.4 Terminal Portability (TP) for ISDN Extension



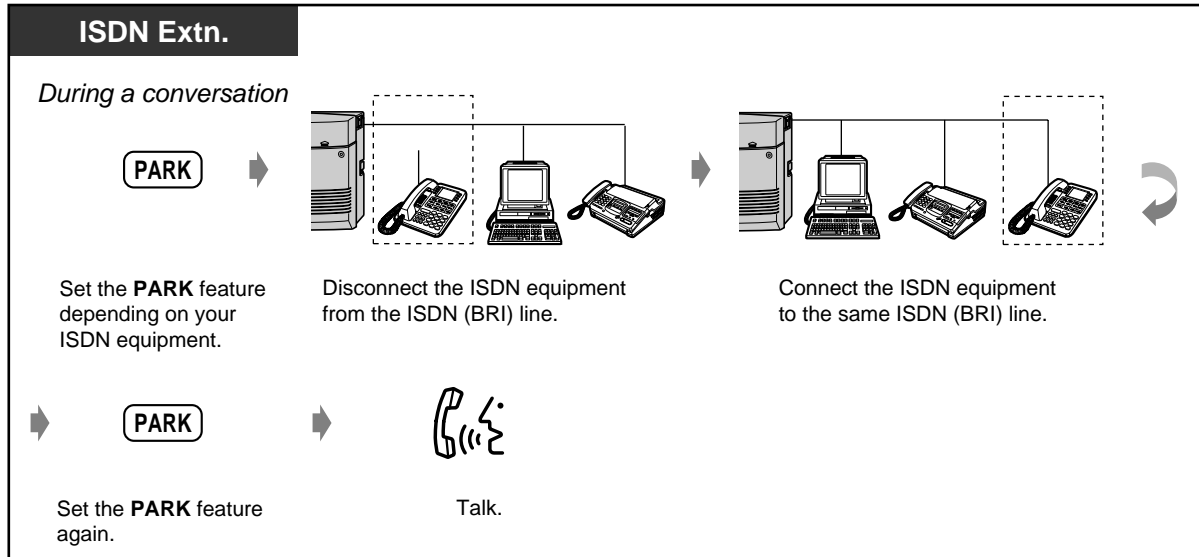

The ISDN extension users can move to anywhere on the same ISDN (BRI) line with holding a call. If your ISDN extension is on the ISDN (BRI) line connected to the port 2, you cannot move to the ISDN (BRI) line connected to the port 3.

◆ **To move with holding a call**



2.4.5 Talking to Two Parties Alternately (Call Splitting)

When talking to 1 party while the other party is on hold, you can swap the calls back and forth (alternately).

DPT	
<p><i>During a conversation with a held call when either party is an outside party</i></p> <p> (CO)</p> <p> OR</p> <p> INTERCOM</p> <p>Press CO or INTERCOM.</p>	<p><i>During a conversation with a held call when both parties are an extension party</i></p> <p> HOLD</p> <p>Press HOLD.</p>

SLT
<p><i>During a conversation with a held call</i></p> <p> (Recall)</p> <p>Press Recall.</p>

ISDN Extn.
<p><i>During a conversation with a held call</i></p> <p></p> <p>Press R key.</p>

2.4.6 Transferring a Call

— Transferring to an extension

— Transferring to an external party

◆◆ Transferring to an extension

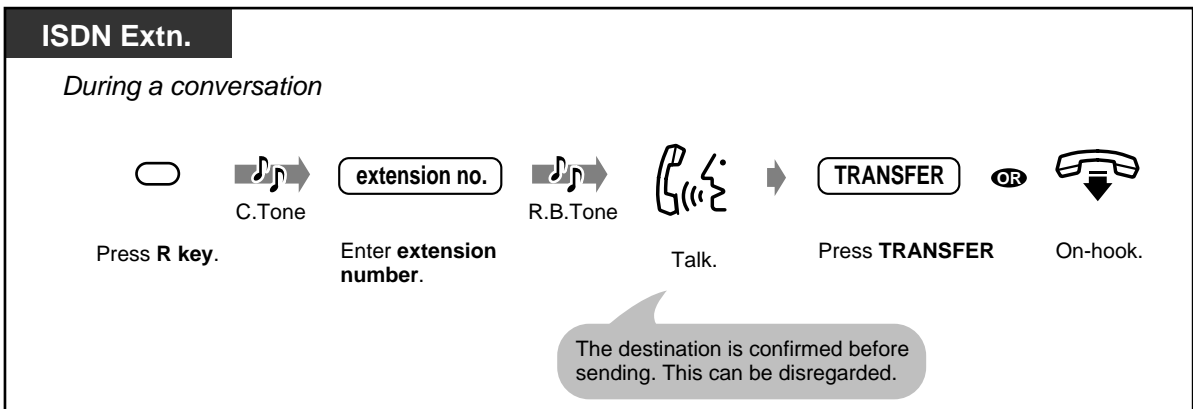
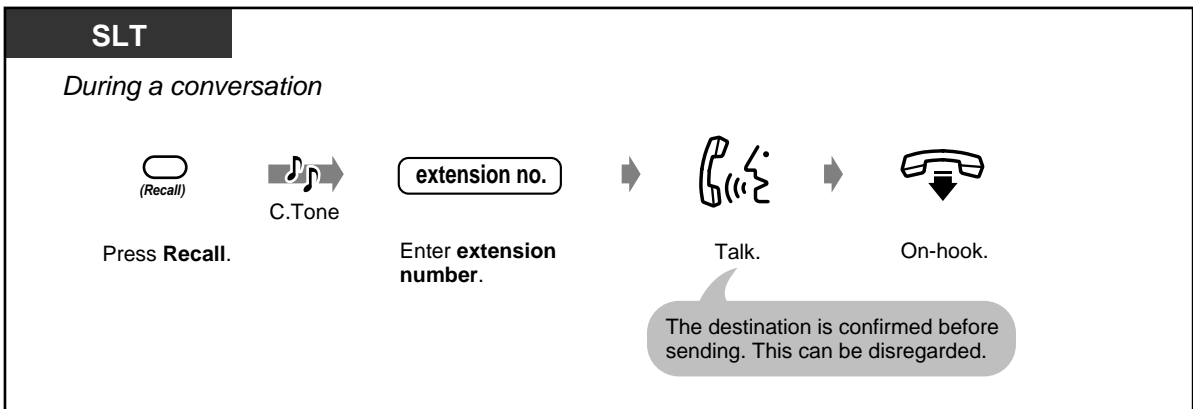
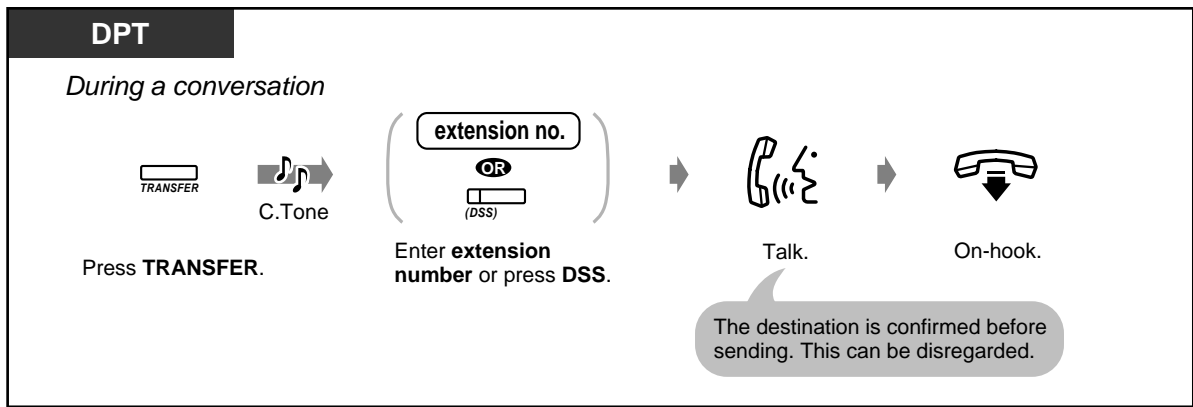

◆◆ Transferring to an external party

Some extensions may be restricted from performing this function.

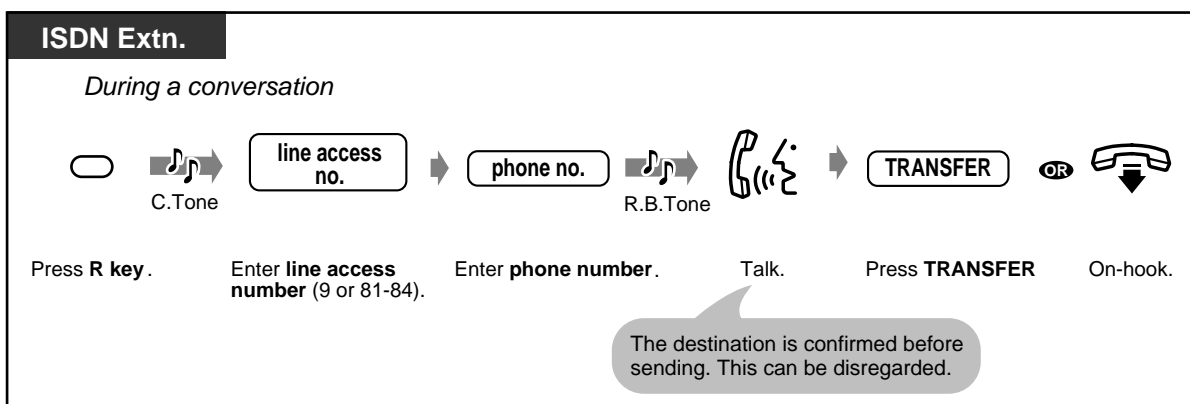
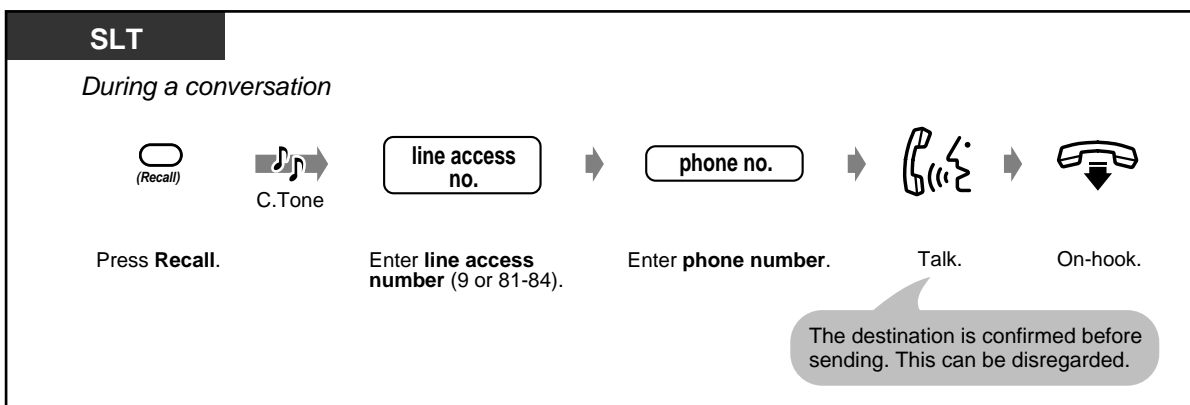
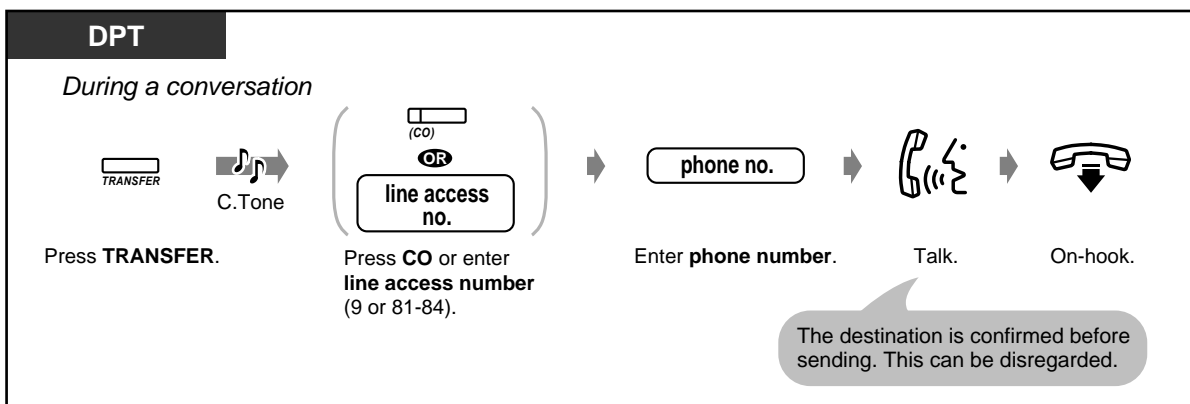

- **If you misdial**, press the R (FLASH) button (digital proprietary telephone only), and re-enter the number.
- **To return to the held call before the destination answers**, press the TRANSFER button, corresponding CO, INTERCOM button, or the Recall (SLT only).
- **To return to the conversation after completing the transfer to an external party**, press the corresponding CO button.
- **If you hear an alert tone**, the destination extension did not answer the call. Answer the call.
- **If you transfer a call with the DSS button or One-Touch Dialling with Auto Hold button**, you do not have to press the Transfer button (One-Touch Transfer).





- 4.1.3 Customising the Buttons
Create or re-arrange a DSS and One-Touch Dialling with Auto Hold button.

2.4.7 Answering a Call Waiting

During a conversation, a call waiting tone or voice announcement through the speaker or the handset occurs when an outside call is received or another extension is letting you know another call is waiting. To activate this feature, refer to 2.8.3 Receiving a Call Waiting (Call Waiting/Off-Hook Call Announcement [OHCA]/Whisper OHCA). (Default: No tone) You can answer the second call by disconnecting the current call or placing it on hold.

◆ To talk to the new party

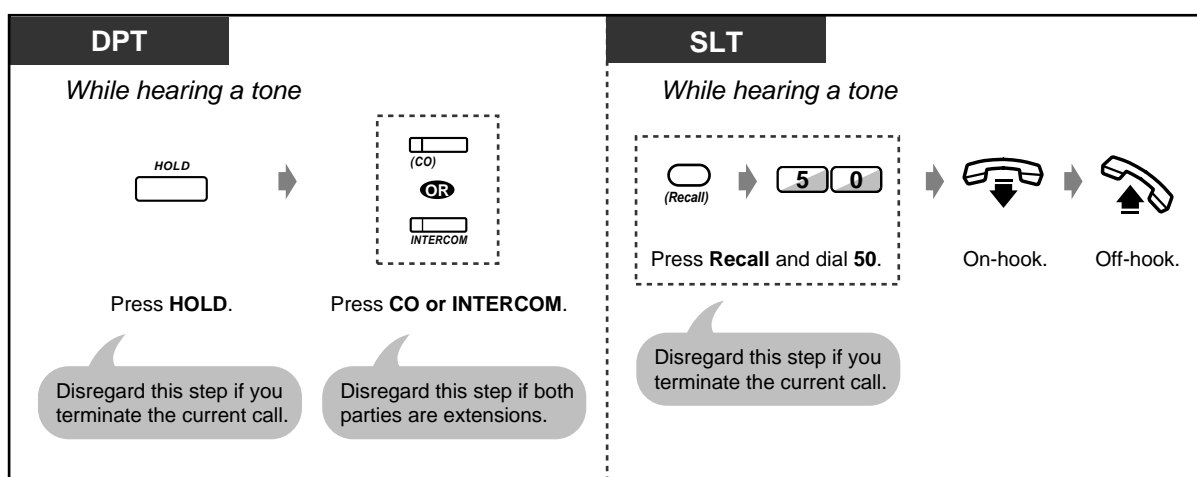

- Depending on the other party's telephone, the "Off-Hook Call Announcement (OHCA)" and the "Whisper OHCA" functions can be applied. You can talk to the other party through the speaker and the microphone (OHCA) or you only receive a call announcement through the handset (Whisper OHCA), while they are having another conversation using the handset.
- The calling extension's name or number is displayed for 5 seconds in 10 second intervals before answering a call.
- As far as it is an intercom, Intelligent Call Handling 1:1 or 1:N call, ISDN extension users can receive a call when (1) both channels of ISDN extension port are used for conversation, and (2) there is no held call at the ISDN extension port.
The user can answer the call by disconnecting the current call or placing it on hold. However, when answering the call by placing the current call on hold, the user cannot transfer nor make a conference involving the held call. When there is a call on wait, no new call can be made by placing the current call on hold.
For any further operating information, refer to the instruction manual of your ISDN extension.



Customising Your Phone

- 4.1.2 Initial Settings—**Call Waiting Tone Type Selection**

Determine the tone depending on the second party, either an outside call or an extension.

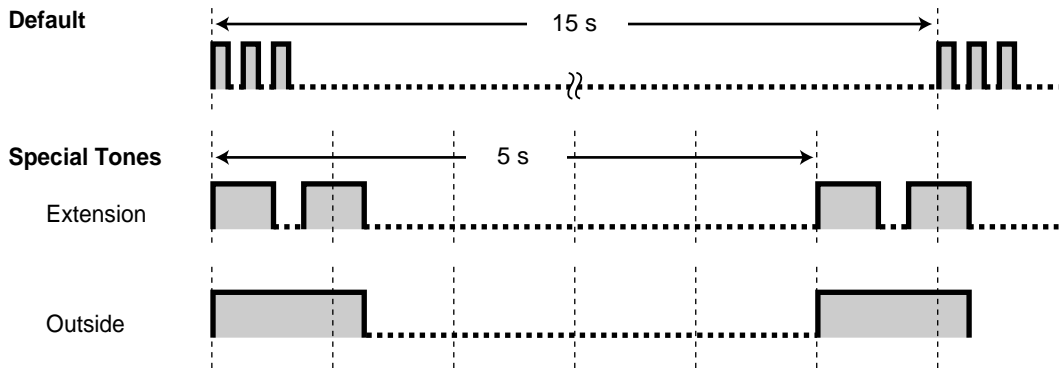

2.4.8 Three-party Conversation

- Adding a third party during a conversation
- Leaving a conference

◆◆ Adding a third party during a conversation (Conference)

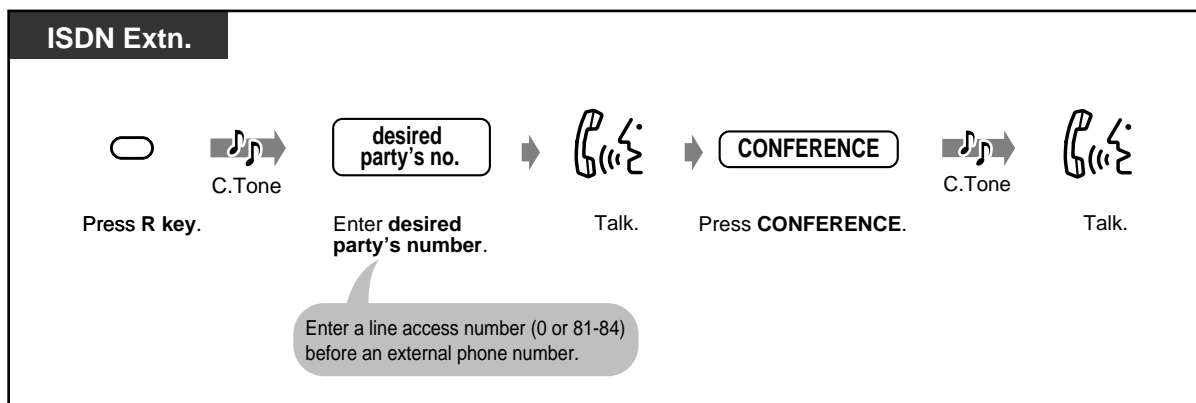
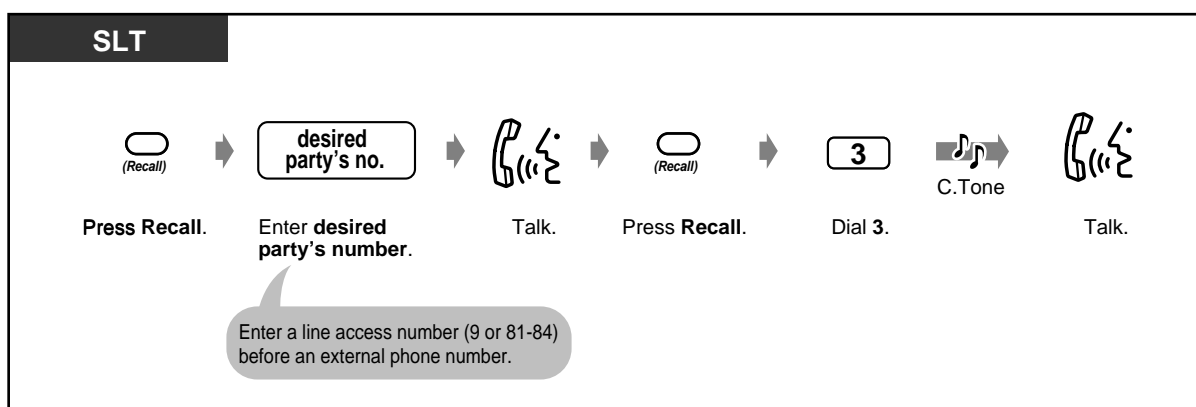
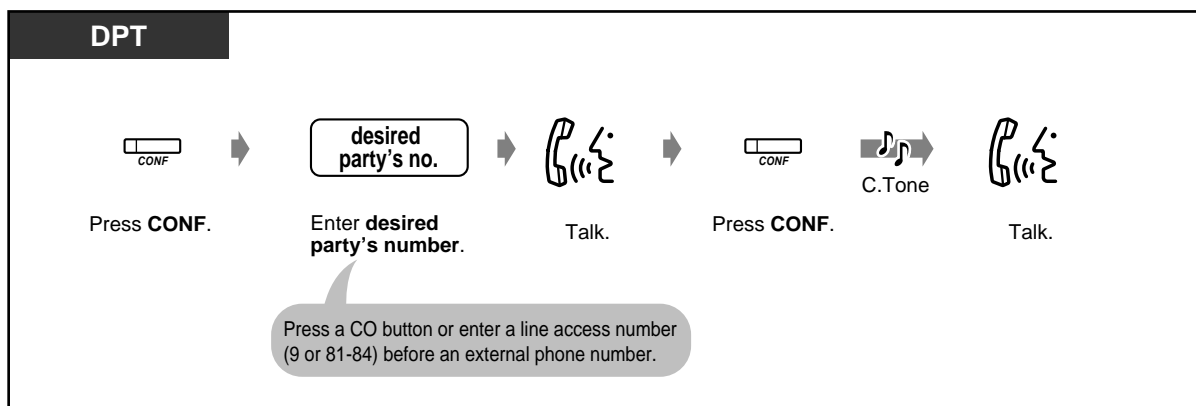

◆ **To talk to one party by disconnecting the other when one of these parties is an outside call**

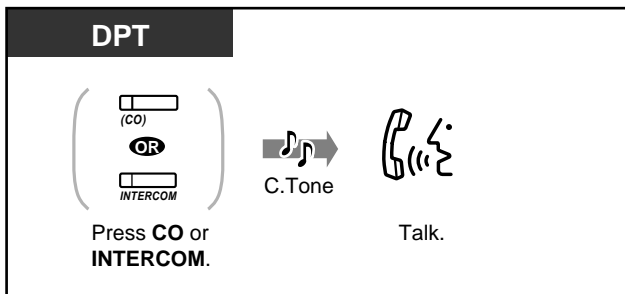

◆◆ **Leaving a conference**

The other two parties can continue their conversation.

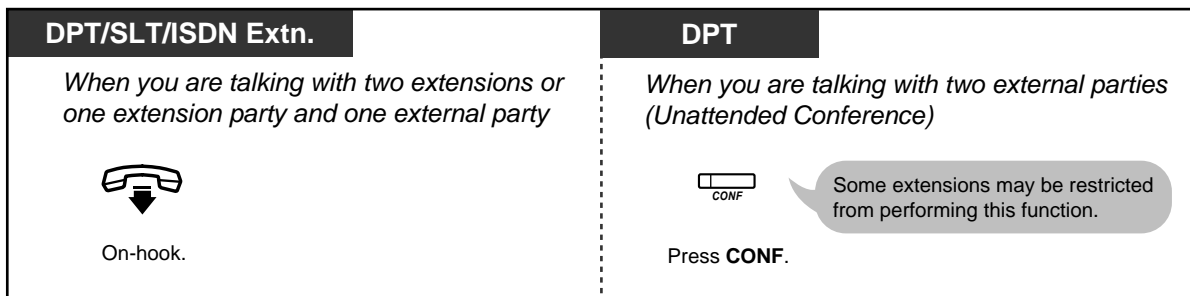

◆ **To return**

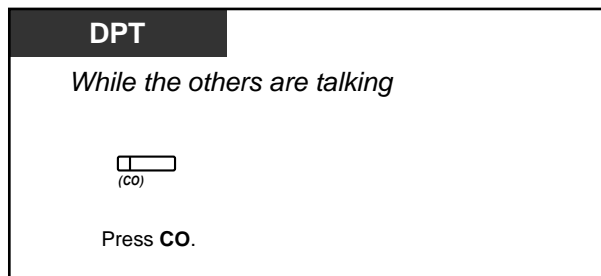

Customising Your Phone

- 4.1.3 Customising the Buttons
Create or re-arrange a Conference button.

2.4.9 Saving a Number (Notebook Function)

You can store a desired outside phone number in memory during a conversation or while on-hook. You can dial the stored number easily.



◆ To store

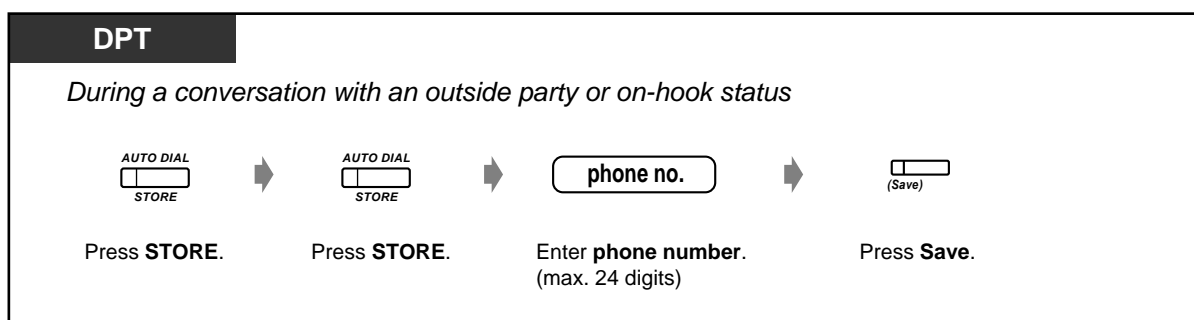

◆ To dial



◆ To dial automatically (Saved Number Redial)

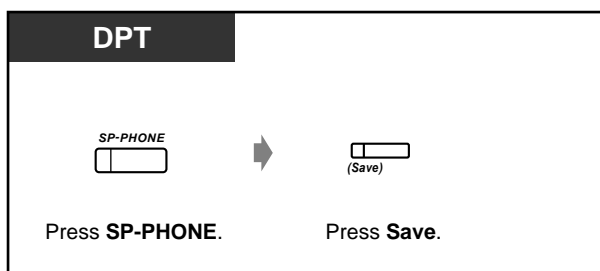

- You do not have to store a line access number before the phone number. An outside line is automatically accessed.
- "*" and "#" can also be stored as a digit.



Customising Your Phone

- 4.1.3 Customising the Buttons
Create or re-arrange a SAVE button.

2.4.10 Mute

You can disable the microphone or the handset to consult privately with others in the room while listening to the other party on the phone through the speaker or the handset.



There are 2 types of mute as follows:

Handset Mute:

During a conversation using the handset. This function is available for the KX-T7400 series telephone users only.

Microphone Mute:

During a conversation using the microphone.

◆ **To set/cancel**

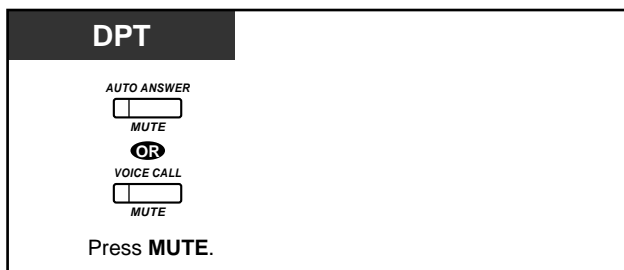

- The AUTO ANSWER/MUTE or VOICE CALL/MUTE button light shows the current status as follows:

Flashing red: Mute

Off: Normal

2.4.11 Letting Other People Listen to the Conversation (Off-Hook Monitor)

You can let other people in the room listen to the conversation through the speaker while continuing the conversation using the handset.



◆ To set/cancel

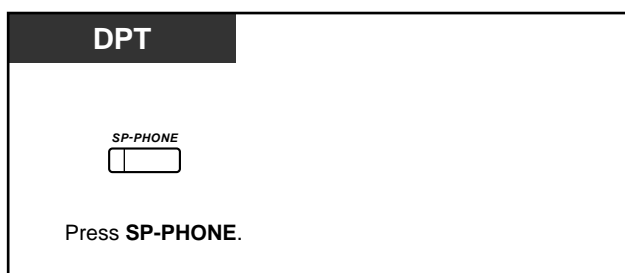

- This feature is only available during a conversation using the handset.
- The SP-PHONE button light shows the current status as follows:
 - On:** The voice is heard through the speaker.
 - Off:** The voice is heard through the handset.

2.5 Using ISDN Additional Services

2.5.1 Transferring a Call from ISDN Line to ISDN Line (ISDN Call Transfer)

You can transfer your calls to an ISDN line without occupying the CO lines.

ISDN Call Hold

You have to let the central office hold a call from an ISDN line as the first step to use the ISDN Call Transfer service or the ISDN Conference service. ISDN Call Hold enables you to hold a call, and to make a call to other external party using only one channel of ISDN (BRI) line.

◆ To transfer

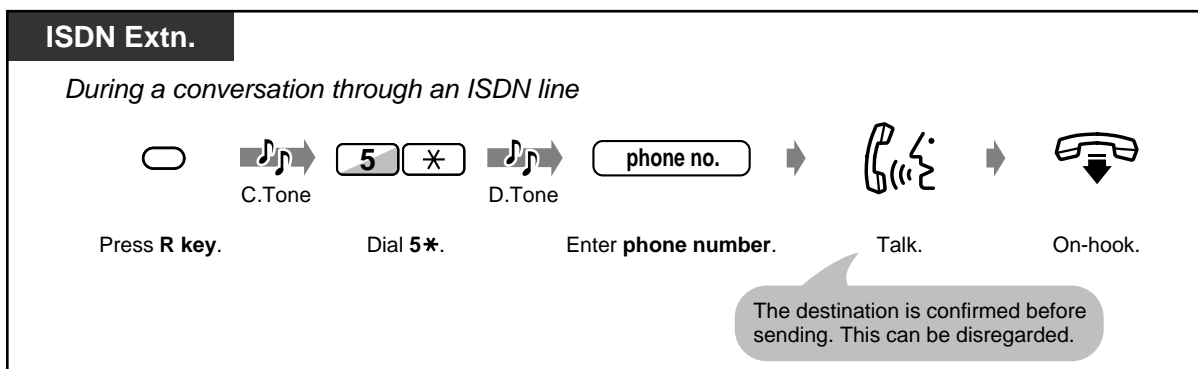
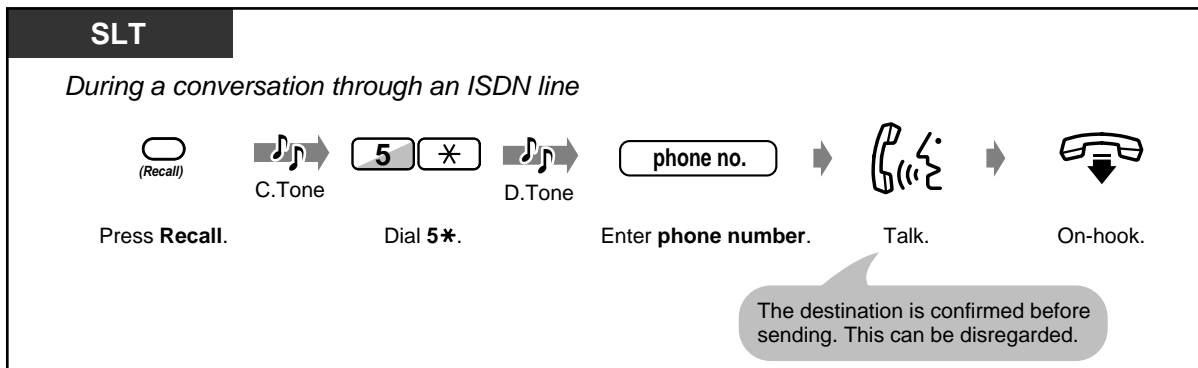
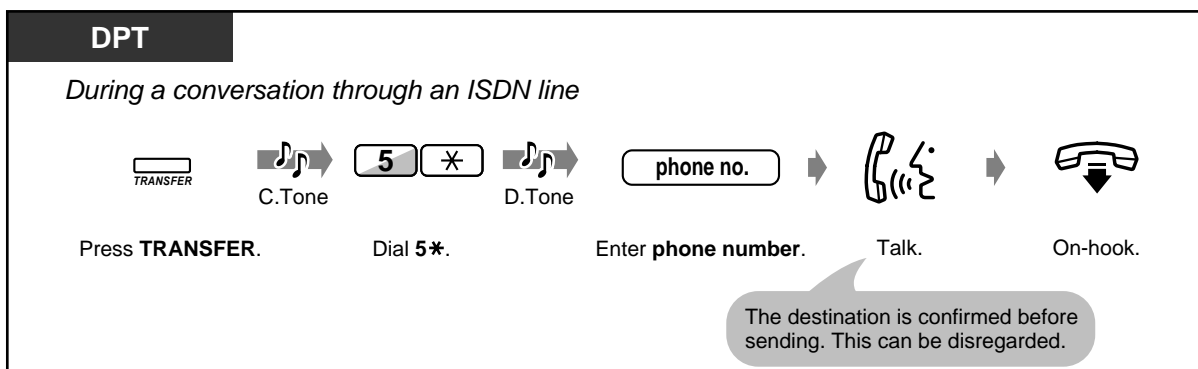



- The availability of this feature is depending on the contract with your telephone company.
- System programming is required. Consult your dealer.
- It is impossible to seize any other CO line during ISDN Call Hold.
- After completing the ISDN Call Transferring service, the CO line will be released. You cannot return to the held call.
- **If you go on-hook except for while hearing ringback tone or during a conversation with the third party**, ISDN Call Hold will be canceled and the system will hold the call.
- **To return to the conversation before the destination answers**, press **TRANSFER** (DPT), **Recall** (SLT), or **R key** (ISDN Extn.).
- It is possible to make a call by using **One-Touch Dialling**. If the dialled number starts with **0, 81, 82, or 83**, these numbers will be disregarded automatically, even in the case that it is not a line access number.
- **If your extension has been restricted**, you might not be able to transfer a call to an external party. *Restricted* will be displayed, and you will hear reorder tone.
- Automatic Route Selection (ARS) will not be applied to the call dialled after **5***.
- The number dialled after **5*** will not be recorded to Station Message Detailed Recording (SMDR). The charge fee will be counted inclusively as the original call you made or you receive.

◆ **If the destination is busy or you misdial**

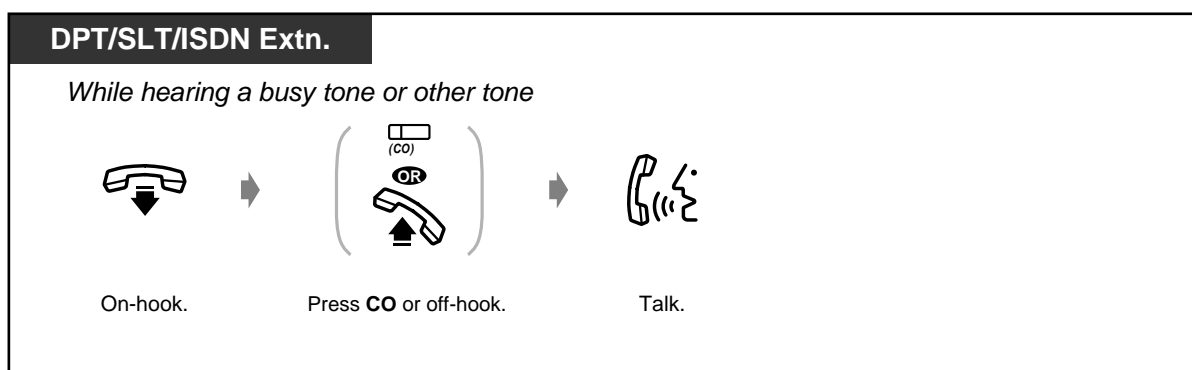

◆ **To split the calls**

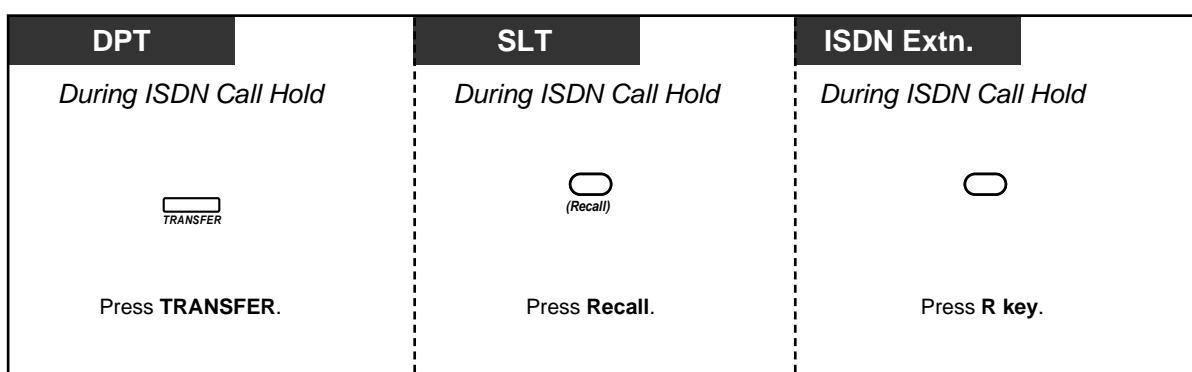



- "1st Party" will be displayed during the conversation with original party.
- "2nd Party" will be displayed during the conversation with new party.

2.5.2 Multi-party Conversation through ISDN Line (ISDN Conference)

You can add one or more parties to your conversation using only one channel of ISDN line.

ISDN Call Hold

You have to let the central office hold a call from an ISDN line as the first step of the ISDN Conference feature or the ISDN Call Transfer feature. ISDN Call Hold enables you to hold a call, and to make a call to other external party using only one channel of ISDN (BRI) line.

◆ To add a party

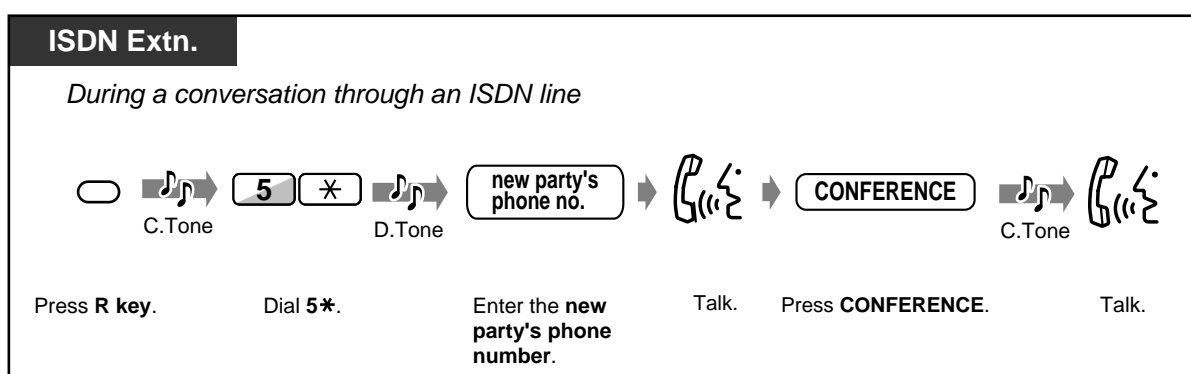
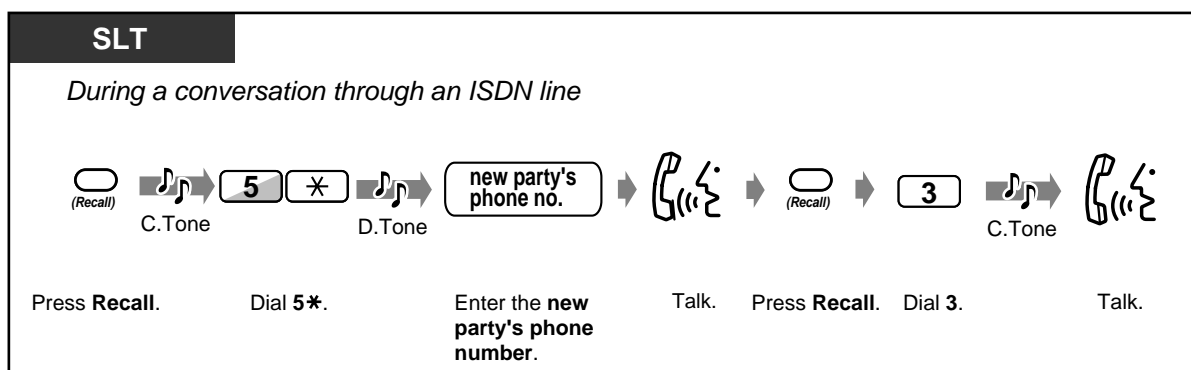
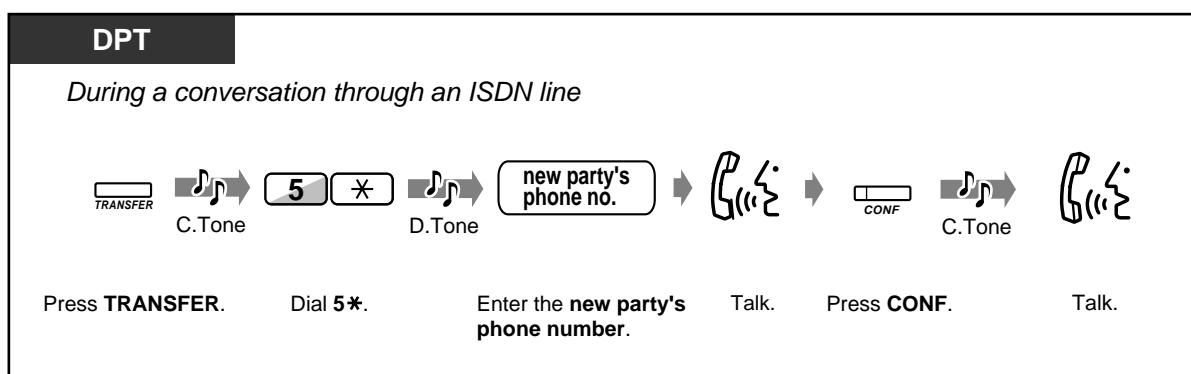



- The availability of this feature is depending on the contract with your telephone company.
- System programming is required. Consult your dealer.
- If **CONF** (more-than-three-party conversion) is selected in system programming, you can add more parties by proceeding the same steps above. The maximum number of the parties depends on your telephone company. Other CONF features, such as dropping or isolating a specific party, are not supported.
- If **3PTY** (three-party conversation) is selected in system programming, you cannot activate ISDN Call Hold during ISDN Conference.
- If you go off-hook during conference, the line is disconnected.

2.5.3 Forwarding Your Calls without Occupying Your CO Line (ISDN Call Forwarding)

You can forward your calls to outside party without occupying the CO lines of your system. This is only available for Intelligent Call Handling 1:1 calls.

◆ **To set**

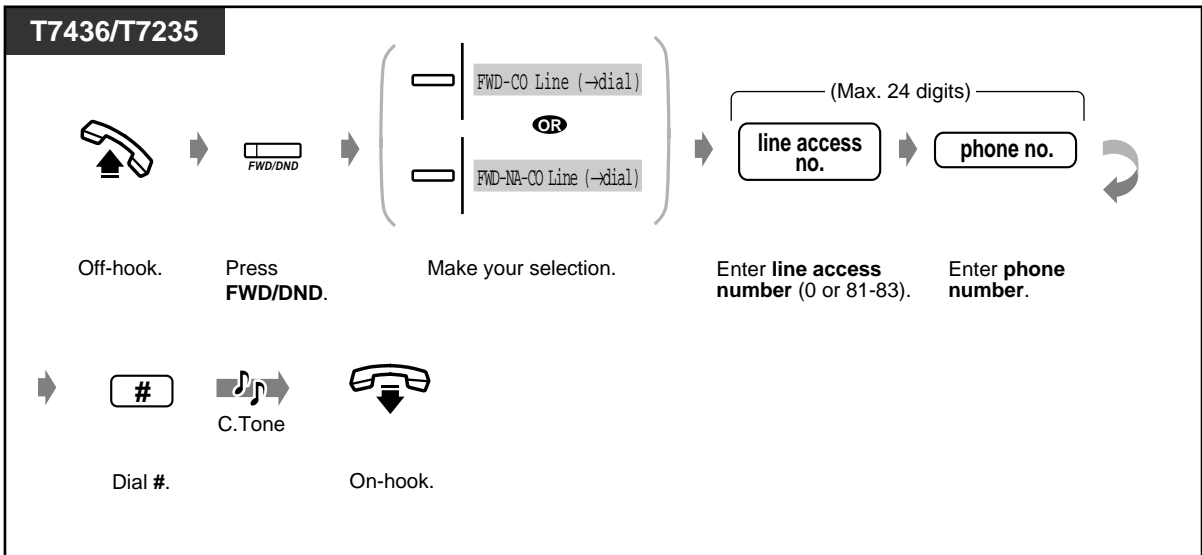
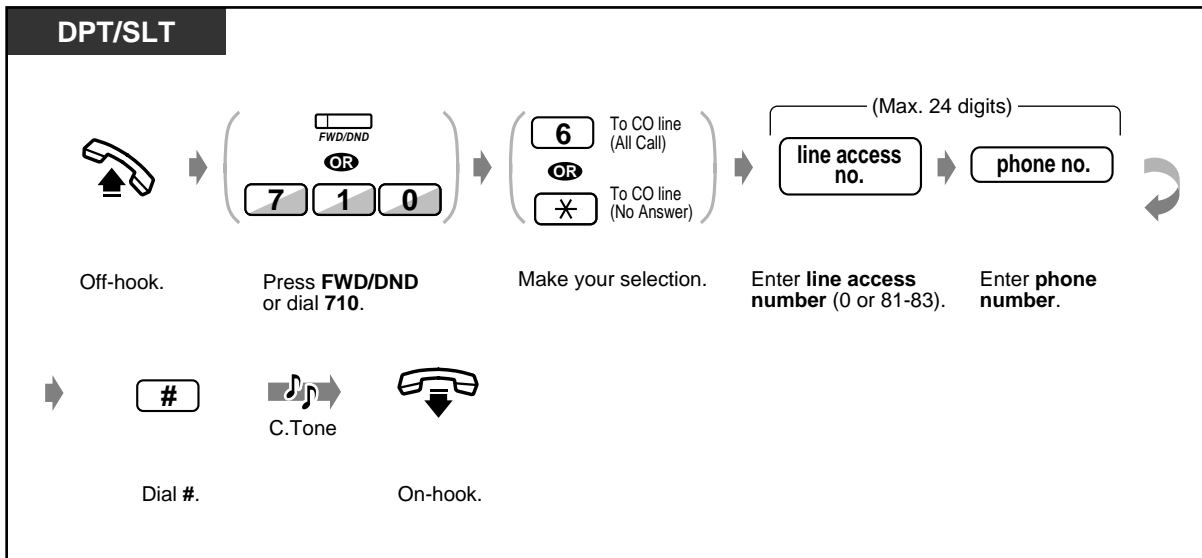

◆ **To cancel**

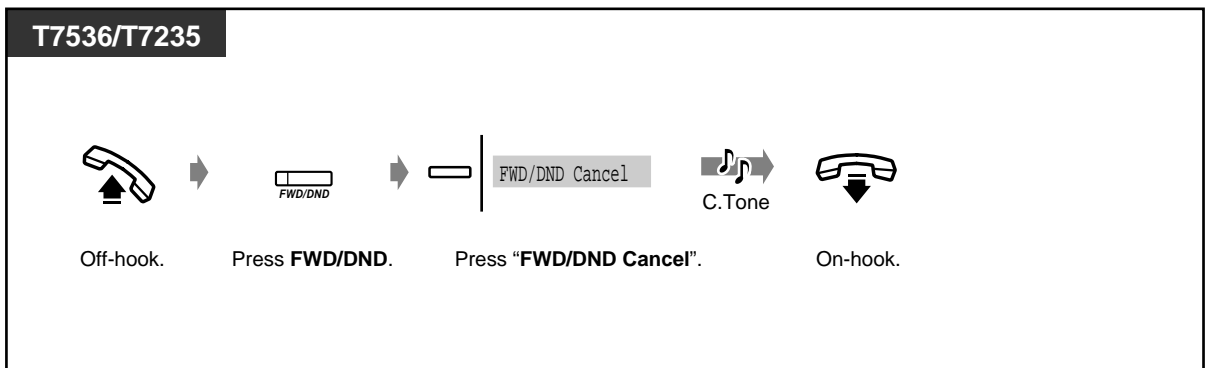
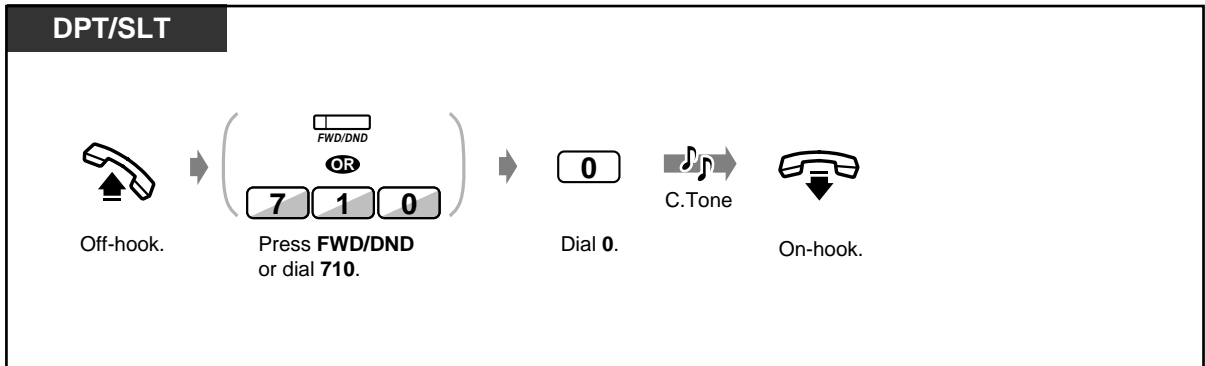

- The availability of this feature is depending on the contract with your telephone company.
- System programming is required (default: disable). Consult your dealer.
- If this feature is enabled, ISDN Call Forwarding is operated prior to the usual Call Forwarding to Outside feature.
- If the network rejects the activation of ISDN Call Forwarding, the incoming call will be disconnected.

2.6 Before Leaving Your Desk

2.6.1 Built-in Voice Message

- Recording, replaying, or deleting Outgoing Messages
- Setting or canceling the Built-in Voice Message function
- Leaving, replaying, or deleting voice messages

This function is only available if an optional card KX-TD61291 is installed in the main unit KX-TD612. Installing this optional card enables you to use these features.

- Internal/External (Intelligent Call Handling 1:1) callers forwarded to your message box can leave their messages in it.
- External callers guided by company outgoing messages can leave their messages in the company (operator) message box. (Refer to 3.2.3 Recording Company Greeting Outgoing Messages.)
- Replay or delete the recorded messages from your extension. A password is necessary for remote replaying or deleting through CO lines.
- **The Direct Message function:**
Allows you to leave a voice message in other extension's personal voice message box, even if the extension has not been set to forward an incoming call to its personal message box, or has not recorded any OGM.

Extension/Company OGM:

Used for the greeting message or guidance when you cannot answer the incoming calls. (Refer to 3.2.3 Recording Company Greeting Outgoing Messages)

Timed Reminder OGM:

Often used as a wake-up call which is played when answering the Timed Reminder alarm. Each extension can record 1 Timed Reminder OGM. (Refer to 2.8.1 Setting the Alarm (Timed Reminder)) You can also play back the recorded message for confirmation.

Call Log

You can refer the call log. Up to 128 call information can be logged. This is owned jointly with the Call Log – Incoming. As for the call information of the Built-in Voice Message, the call information will be logged per calling even when the several calls from the same telephone number. However, the oldest call information will be overwritten by the 129th call regardless of the ordinary call log or that of the Built-in Voice Message. (Refer to 2.10.1 Calling Using the Call Log (Incoming Call Log) [KX-T7433, KX-T7436, KX-T7230, KX-T7235 only])

Note

- Be sure to assign the Intelligent Call Handling table beforehand. Otherwise, outside caller cannot access the company message box. (Refer to 4.2.3 System Speed Dialling and Intelligent Call Handling Number Set (001)) Consult your dealer for detailed assignment.
- When the call information of the Built-in Voice Message is overwritten, the voice message itself is deleted at the same time.
- If you set the Voice Mail feature, the functions of the Built-in Voice Message (BV) will be disabled except for the following.
 - (1) **Company Greeting OGM for DISA feature**
 - (2) **Recording, replaying, or deleting Company Greeting OGM**



- Only the operator is possible to replay/delete the voice messages stored in the company message box. (Default: Operator=Jack 1-1)
- Only 1 call can have access to 1 voice message resource. When someone is recording a message or OGM with the same resource, your access will be rejected and you will hear a reorder tone/warning tone (when using SOFT key on digital proprietary telephone).
- The LED indicator of the MESSAGE button is lit red, if there are any voice messages not yet heard.
- If a call fails to have access to the voice message box, with an internal call, the extension will ring, with an external call, the extension assigned in system programming will ring. Ask your manager.
- You can choose the total recording time for the Built-in Voice Message feature (including OGM such as OGM for Built-in Voice Message, UCD message and Timed Reminder message) out of 60 minutes/30 minutes/20 minutes. (Default : 30 minutes) Ask your dealer.
- When the rest of recording time becomes less than 5 minutes, Voice Msg Full will be displayed, and you will hear dial tone 6 when going off-hook.



- The callback of Automatic Callback Busy (Camp-On) and Hold Recall cannot be forwarded.

◆◆ Recording, replaying, or deleting Outgoing Messages

◆ To record the extension Outgoing Message (OGM)/Timed Reminder OGM

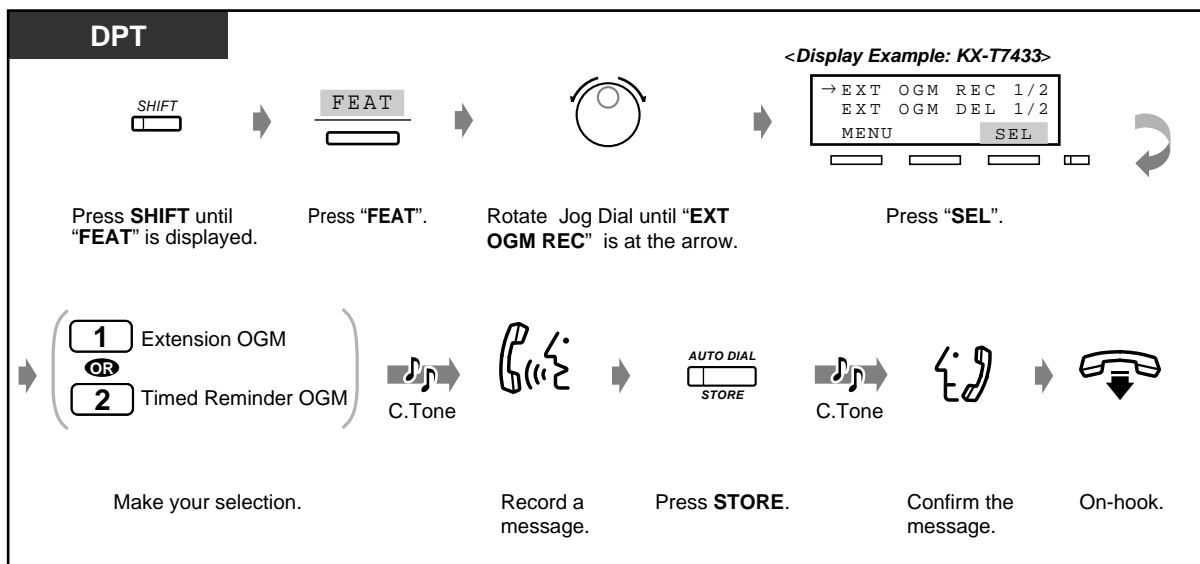

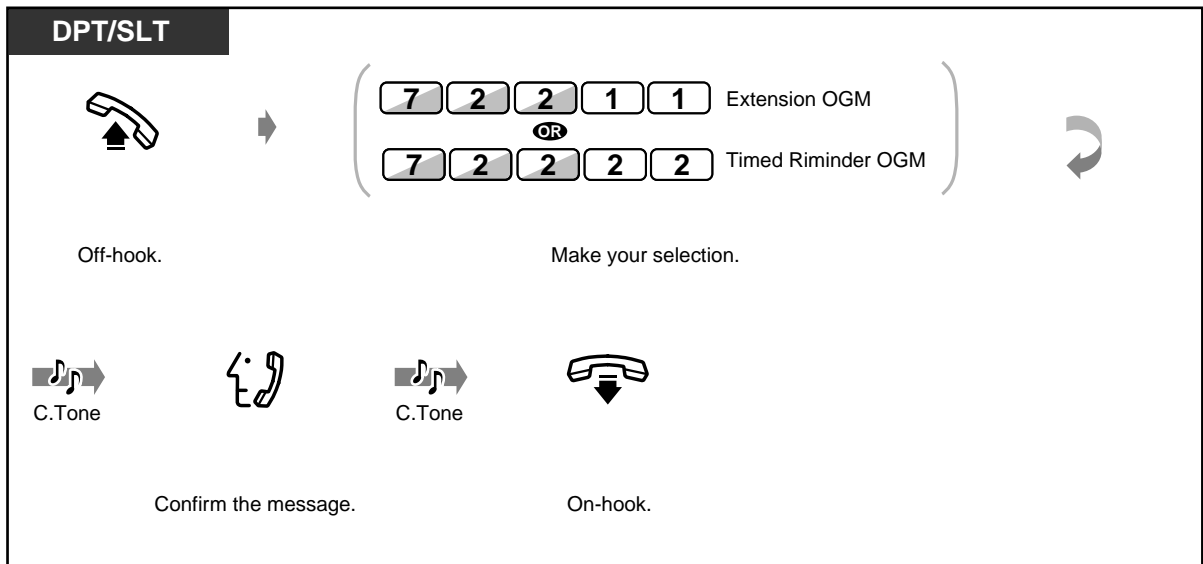

◆ **To delete OGM/Timed Reminder OGM**

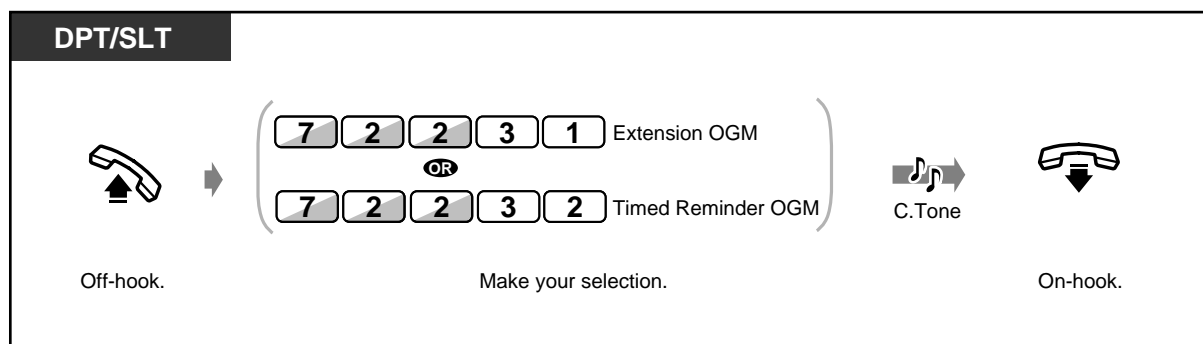
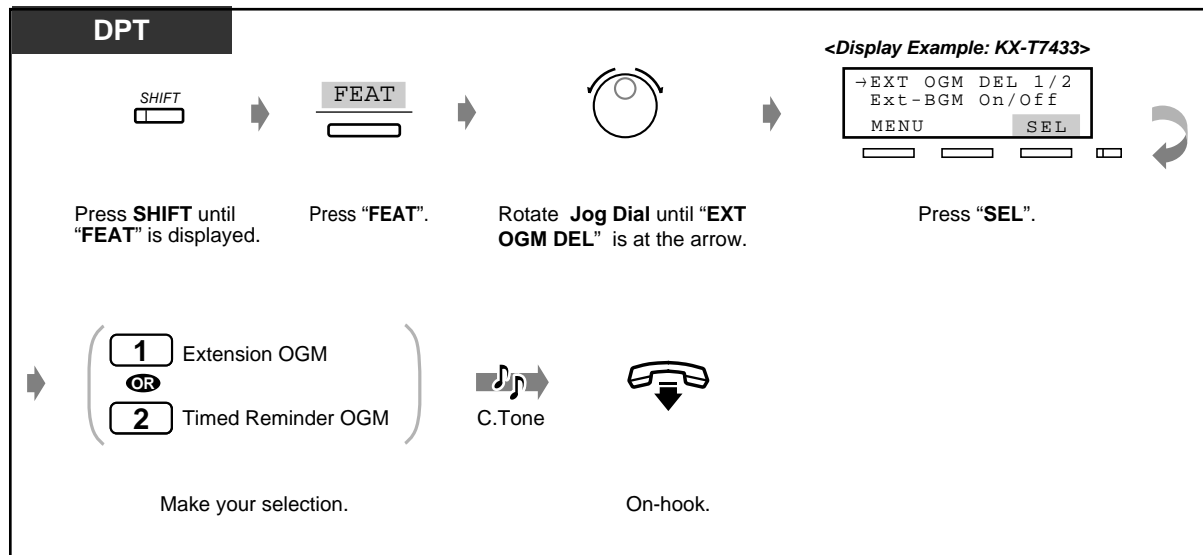



- You can record or delete an OGM only when no one else is using this feature such as replaying/recording/deleting a voice message or an OGM. If you try to record an OGM when someone else is using this feature, you will hear a reorder tone, and OGM BUSY will be indicated on the display (for Digital Proprietary Telephone user only).

◆◆ Setting or canceling the Built-in Voice Message function

◆ To set the voice message function

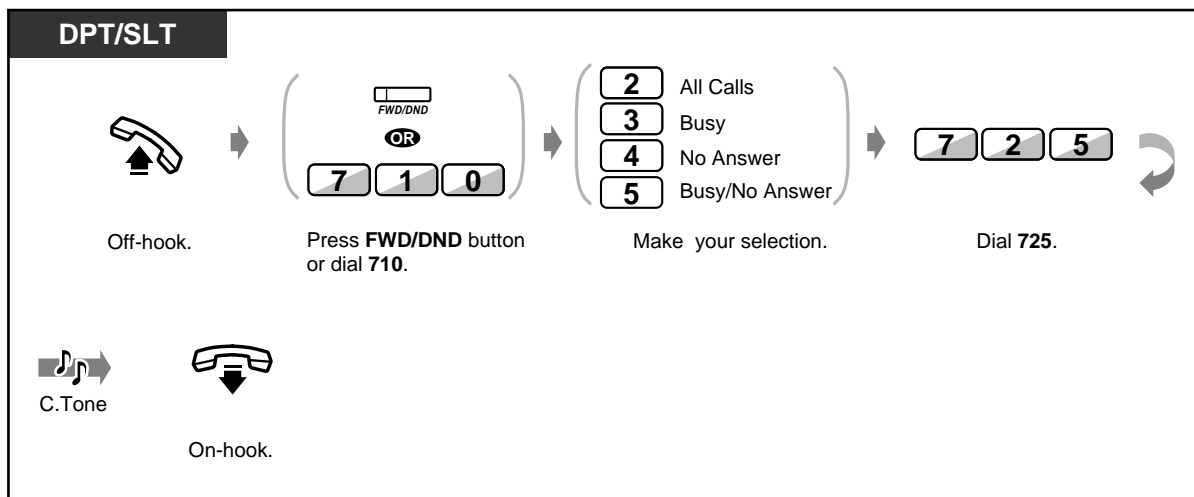

- If an OGM is not stored for your personal message box, an incoming call cannot be forwarded. Your extension will ring.
- If you set this feature, dial tone 2 will sound when you go off-hook.

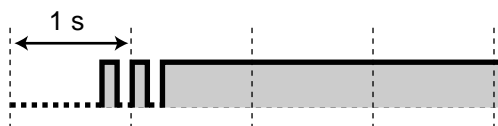

- This feature cancels other types of Call Forwarding, Do Not Disturb (DND) and Do Not Disturb (DND) for Intelligent Call Handling 1:1 Call.

◆ To cancel the voice message function

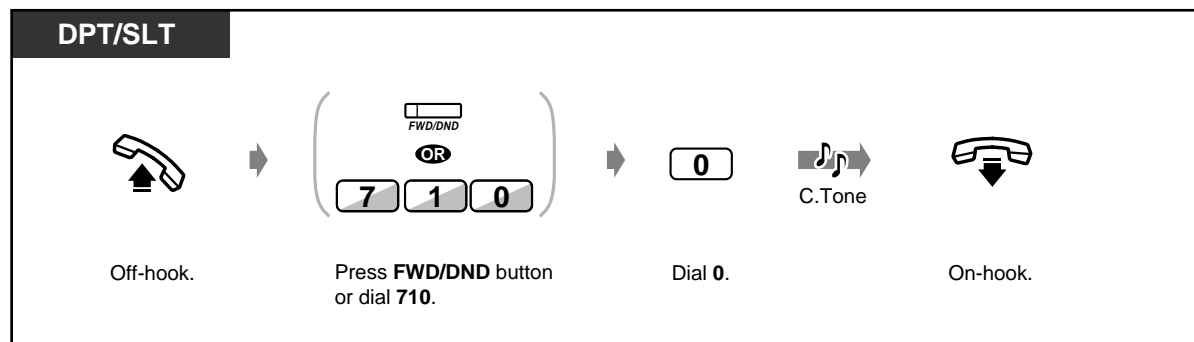

◆◆ **Leaving, replaying, or deleting voice messages**

◆ **To leave a message using the Direct Message function**

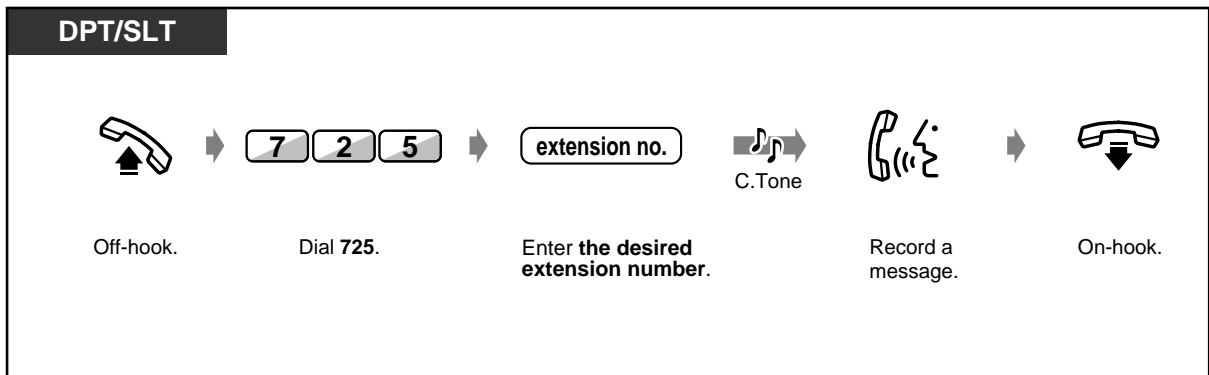

- "NOW RECORDING" will be displayed when recording a message (DPT only).
- You can end the recording by pressing the STORE button. In this case, "REC Complete" will be displayed (DPT only).

◆ **To replay the message which is not yet heard**



- If you go off-hook, dial tone 5 will be heard.



- If you press the MESSAGE button while on-hook, "Voice Message" will be displayed (for DPT with display user only).

◆ **To replay the message**

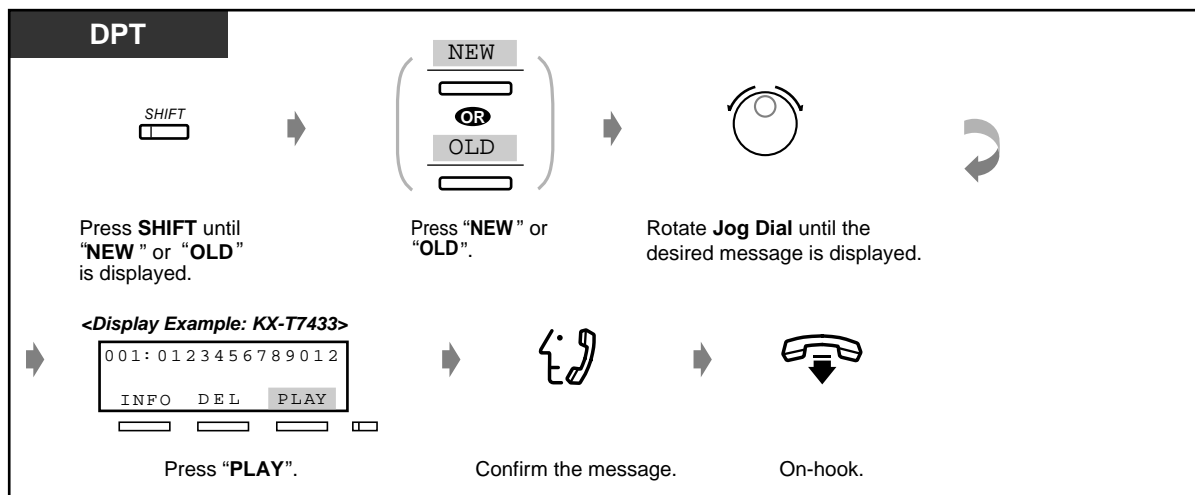

- You can stop replaying a message by pressing the "MENU" key during the replay.

◆ **To replay all messages**

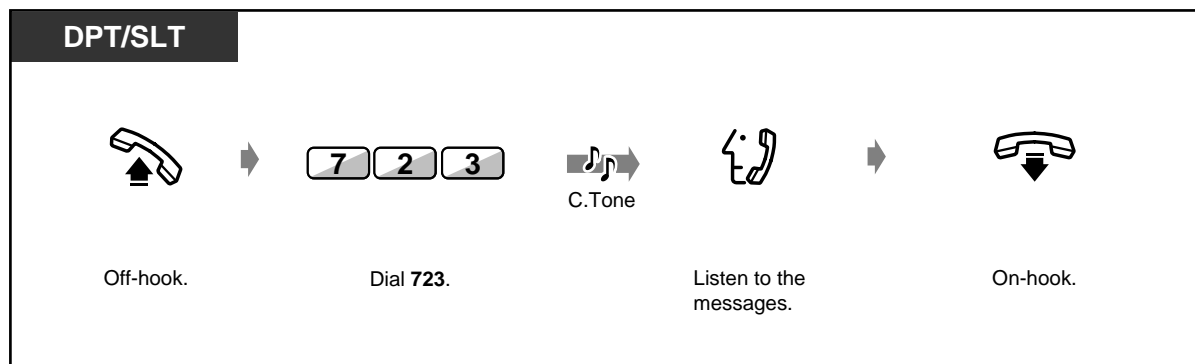

- If you press the MESSAGE button while on-hook, "Voice Message" will be displayed (for DPT with display user only).
- In call log function, if the call log entry of the voice message is overwritten, the voice message itself is deleted at the same time.
- Pressing the PLAY key during replay enables you to replay the same message again.



Customising Your Phone

- 4.1.3 Customising the Buttons
Create or re-arrange a MESSAGE button.

◆ **To replay/delete the messages from the outside**

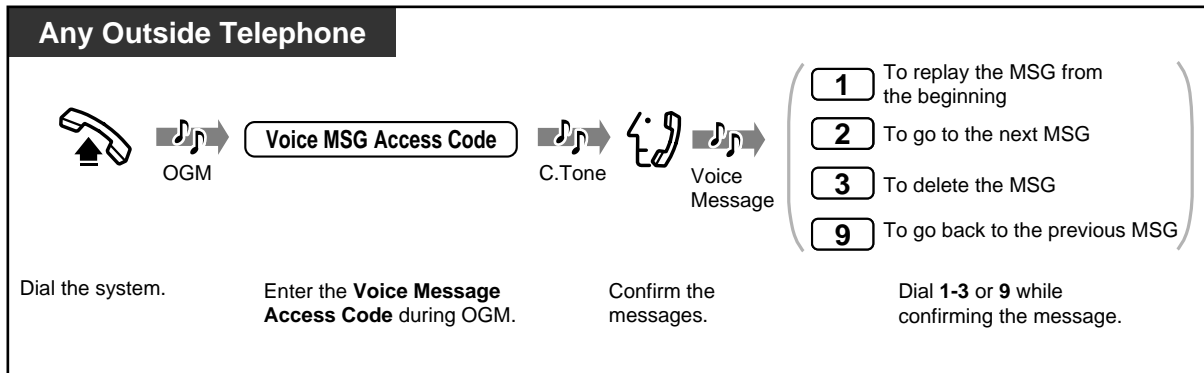

- You can enter a Voice Message Access code while you are hearing OGM for company message box or one for personal message box.
- If you enter a wrong Voice Message Access code, the line will be disconnected immediately.
- If a voice message is not recorded, the line will be disconnected automatically.
- When the replay ends, the line is disconnected automatically.
- Even though you delete a voice message from the outside, the call log entry cannot be deleted.
- If you did not enter a Voice Message Access code while hearing an OGM and the rest of recording time of the BV resource is 0, after the OGM was replayed to the end an outside calls rings at the extension in the order of priority described below:
Operator 1 > Operator 2 > Manager > Jack 1-1

◆ **To delete a message**

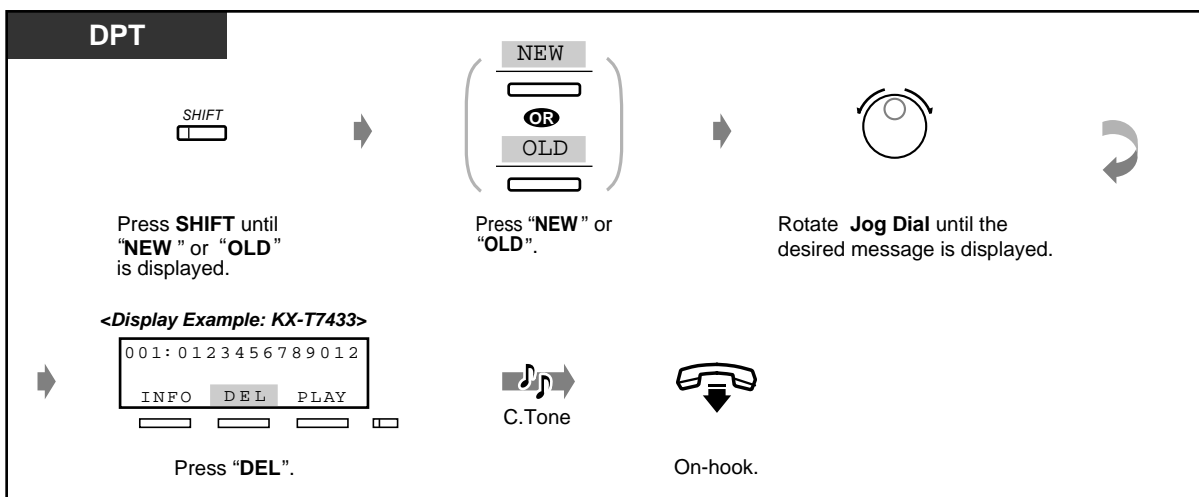

- Pressing the "DEL" key during replay stops the replay and deletes the message.
- Voice messages recorded from an analogue CO line will be stored without entries into the call log. Therefore, these messages can only be deleted when all messages of a personal message box are deleted at once (using deletion code — [default] 724), or are deleted one by one from the outside.

◆ *To delete all messages of a personal message box at once*

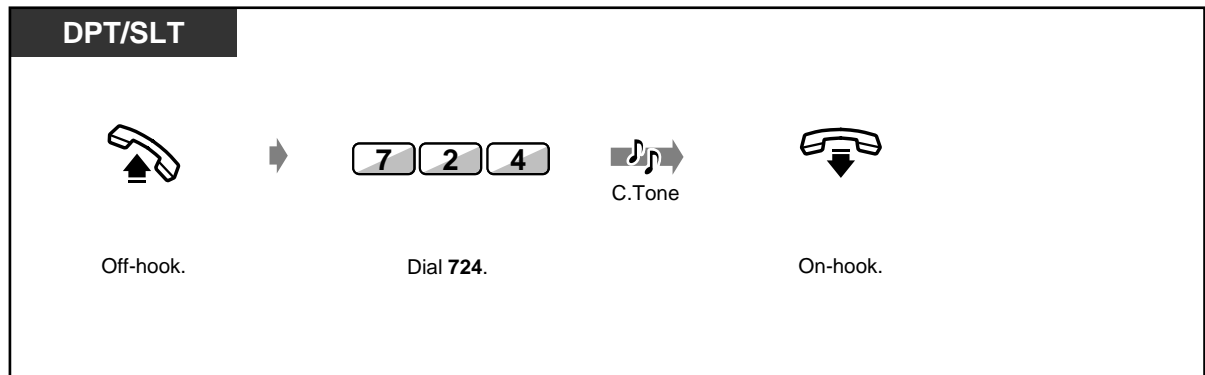

2.6.2 Forwarding Your Calls (Call Forwarding)

- Setting or cancelling the Call Forwarding features
- Call forward to outside line ("Call Forwarding — to CO Line, All Calls" and "Call Forwarding — to CO Line, No Answer") in accordance with pre-selected CLIP and DDI/MSN numbers

You can have your incoming calls forwarded to a specific destination. An internal destination may be an extension or a hunting group.

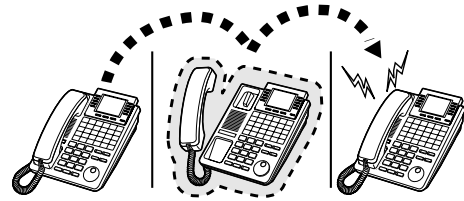

All Calls:

All calls are forwarded to another internal destination.

Busy:

All calls are forwarded to another internal destination when your extension is busy.

No Answer:

All calls are forwarded to another internal destination when you do not answer the call.

Busy/No Answer (BSY N/A):

All calls are forwarded to another internal destination when you do not answer or when your extension is busy.

To Outside Line (CO Line), All Calls:

All calls are forwarded to an external party. You can also restrict calls to forward. Each extension can assign calls from specific caller's number (CLIP) or calls to your specific DDI/MSN number to apply this forwarding function. Some extensions may be restricted.

To Outside Line (CO Line), No Answer:

Calls to your extension will be forwarded to an external destination when you do not answer the call in a pre-assigned time. You can also restrict calls to forward. Each extension can assign calls from specific caller's number (CLIP) or calls to your specific DDI/MSN number to apply this forwarding function.

Follow Me (From):

If you forget to set "All Calls" to be forwarded before you leave your desk, you can set the same functions from the destination extension.

By ISDN Line:

All calls are forwarded to an external party by ISDN line in one of the following conditions

- Unconditionally (Call Forwarding unconditional [CFU])
- When you do not answer (Call Forwarding No Replay [CFNR])
- When you extension is busy (Call Forwarding Busy [CFB])

Some extensions may be restricted.



- You can set your mailbox (VPS) or mobile telephone as the forwarding destination.

◆◆ **Setting or cancelling the Call Forwarding features**

◆ **To set (except "Call Forwarding by ISDN Line")**

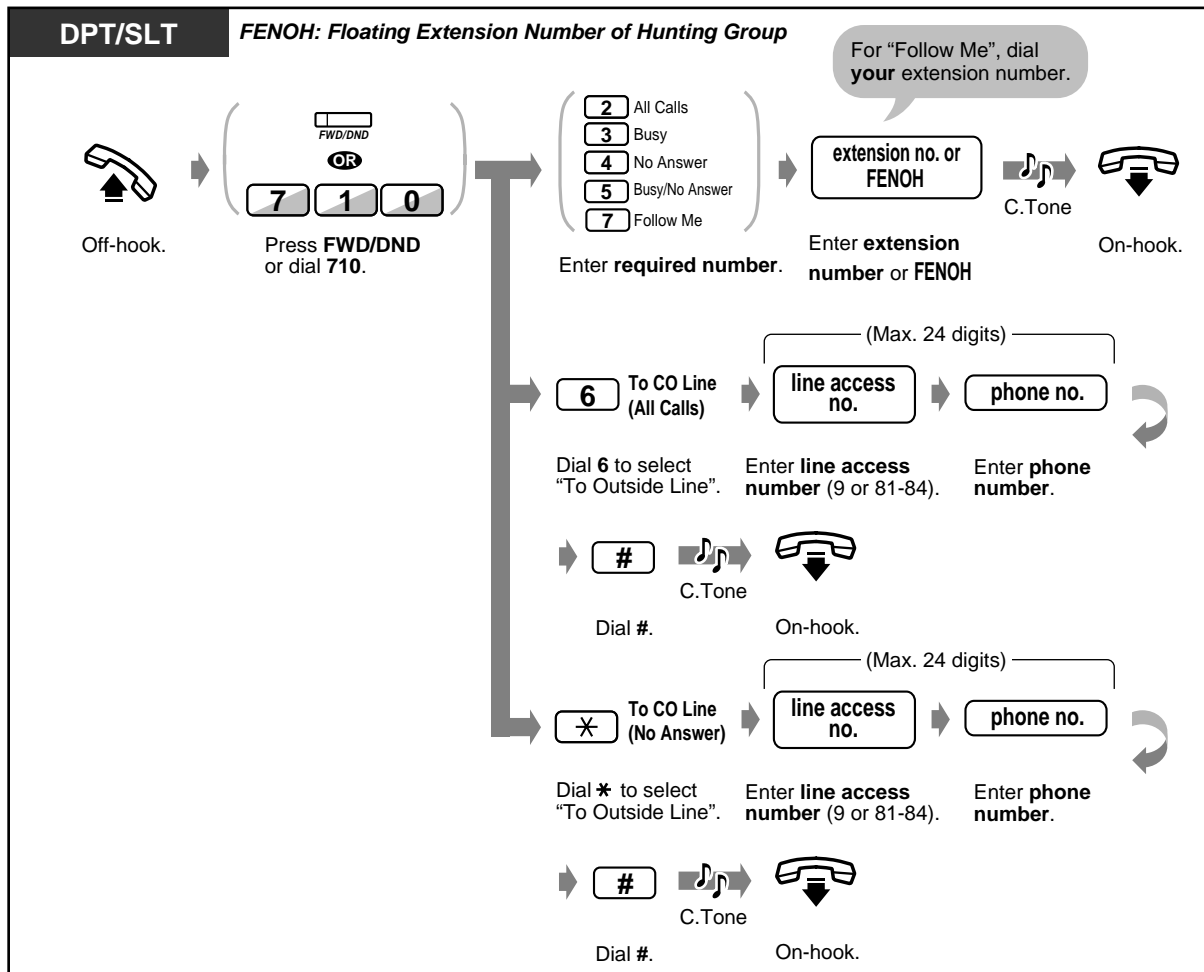

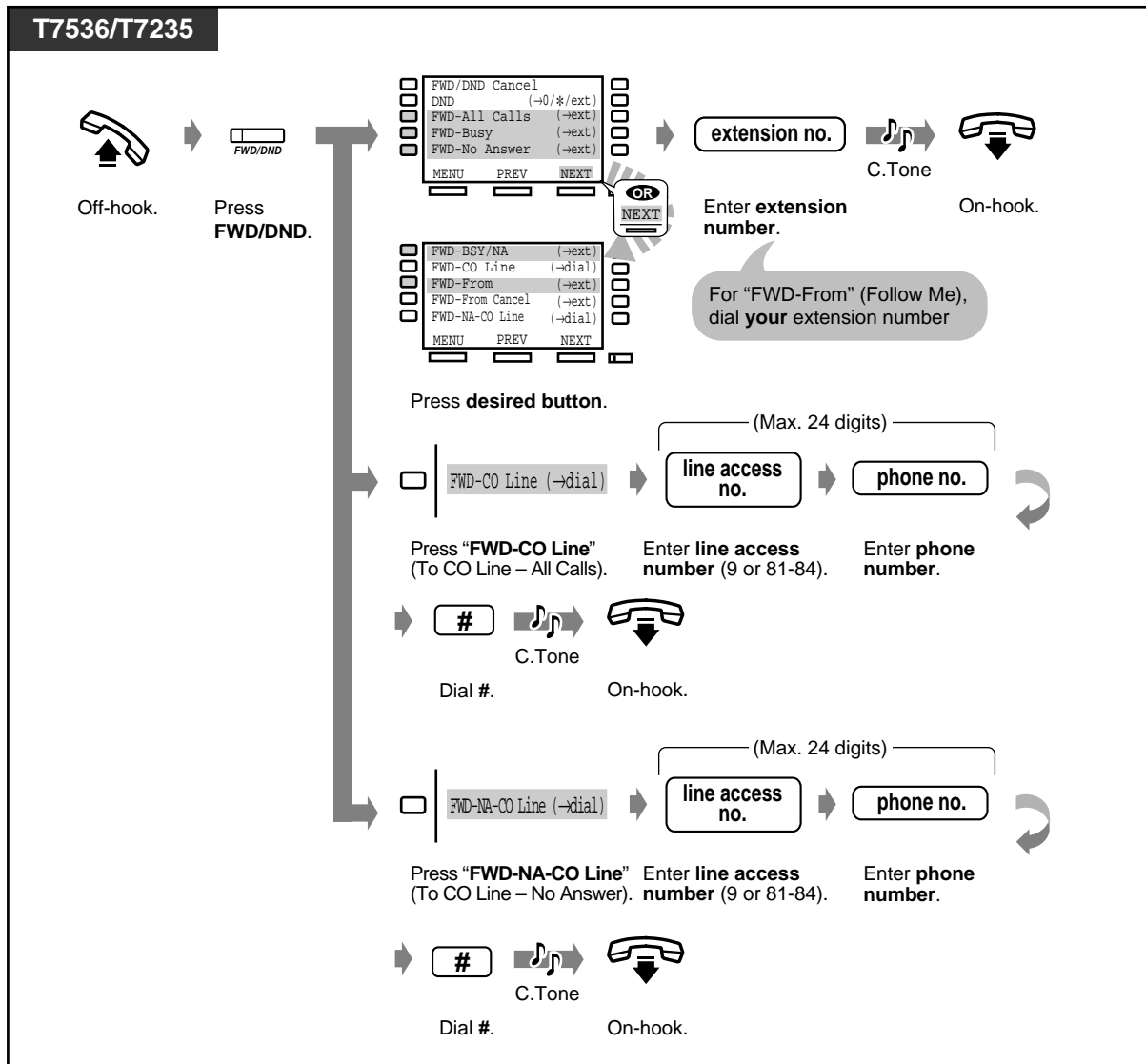

◆ To cancel (except "Call Forwarding by ISDN Line")

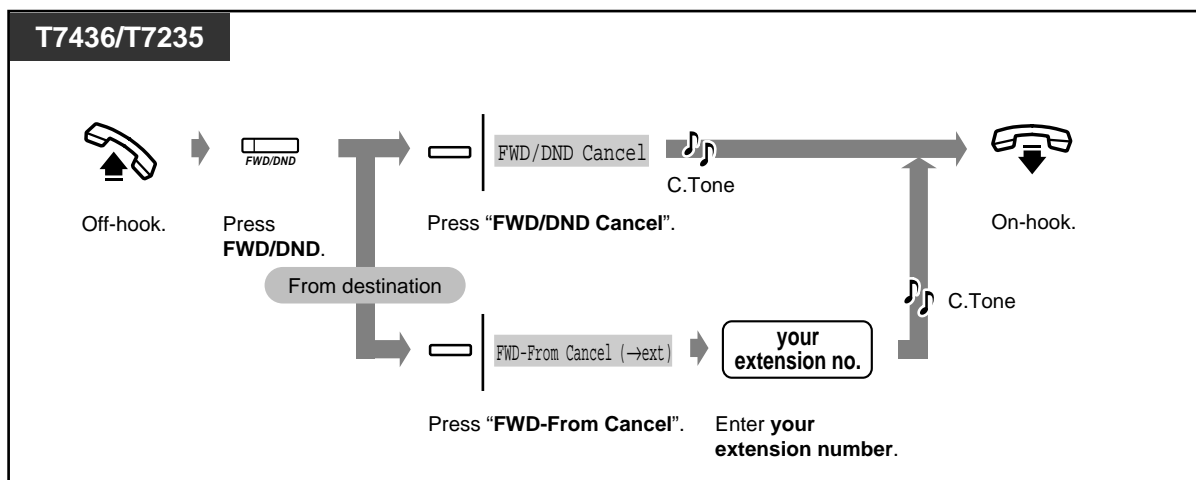
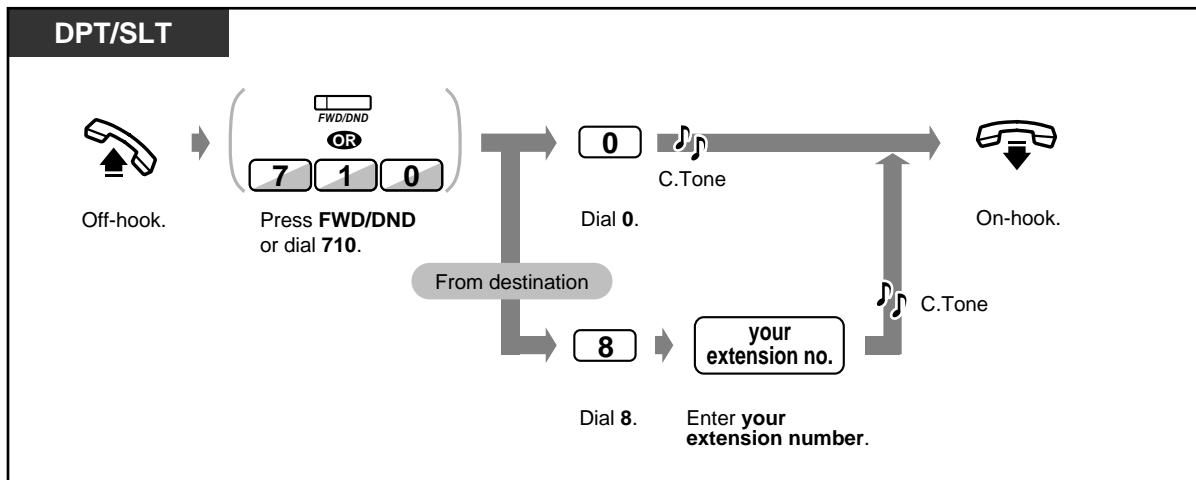

◆ To set "Call Forwarding by ISDN Line"

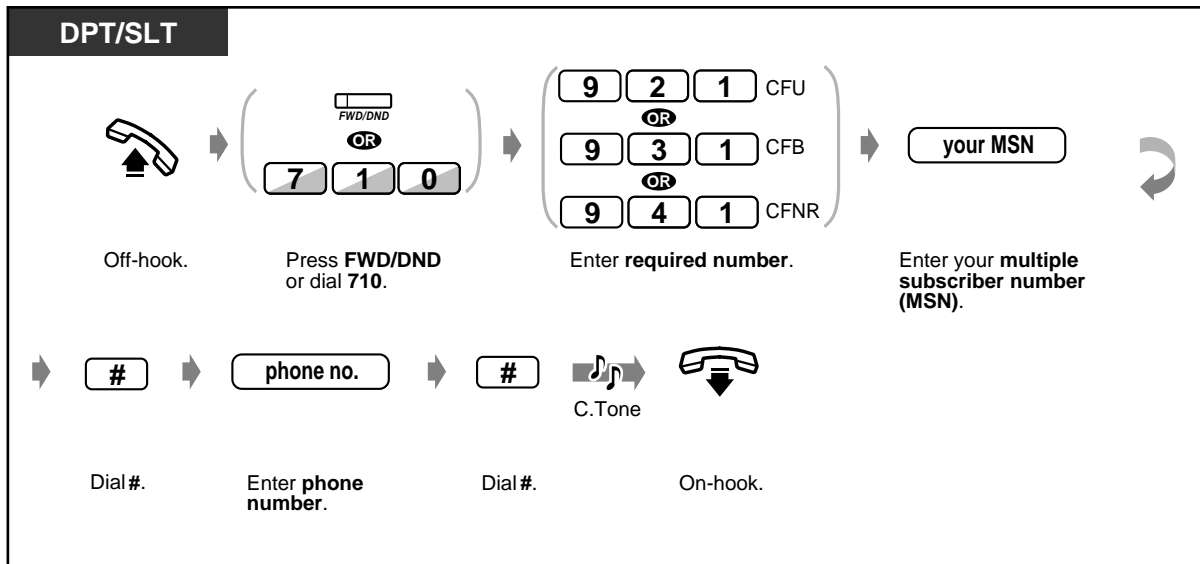

◆ To cancel "Call Forwarding by ISDN Line"

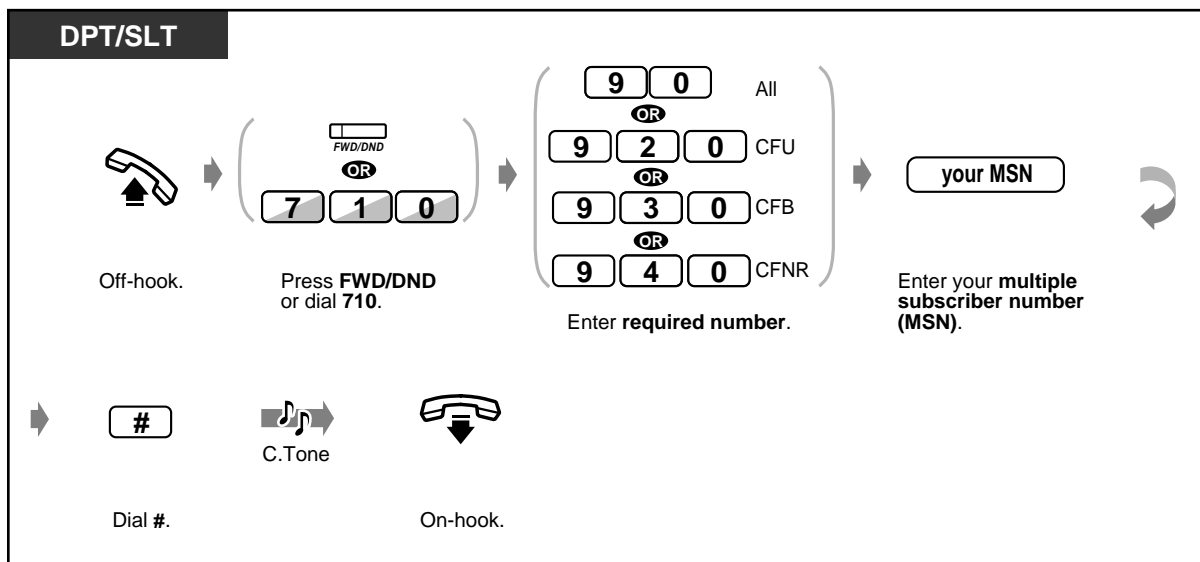



- Each call can be forwarded up to 4 times. The fifth time will be disregarded.

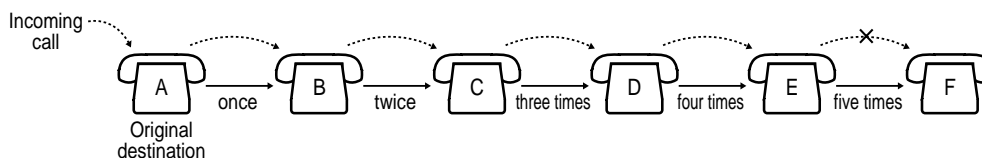

- The calls can be forwarded to the built-in voice message box. To ensure calls are directed to the desired extension, forwarding to another extension's personal message box is not possible.

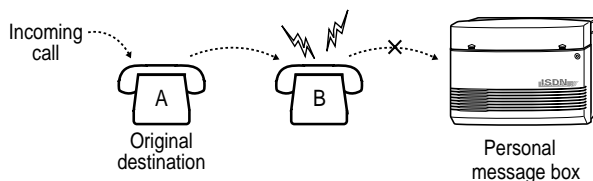

- Call forwarding to the forwarding extension is not possible.

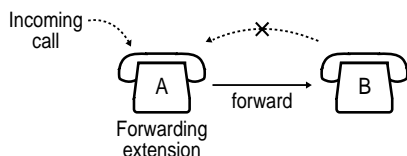

- The extension which is set as the destination can call the original extension.
- The FWD/DND button light flashes red when the Call Forwarding feature is set.
- The Call Forwarding to CO Line (All Calls) can be set or cancelled from outside by Direct Inward System Access (DISA) function. Also, it is possible through DISA to store/delete CLIP and DDI/MSN numbers that are allowed to forward and to activate/cancel them. Refer to 2.2.8 To Access Another Party Directly from Outside (Direct Inward System Access [DISA]).
- **Boss-secretary function**
The extension which has been set as the destination can call the forwarding extension. Also, any extension in the hunting group which has been set as the forwarded destination can call the forwarding extension.

<Example>

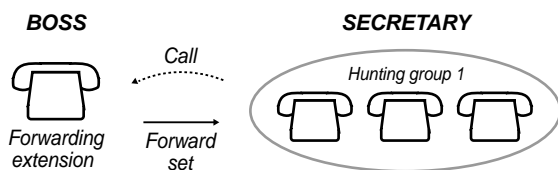

- Some ISDN operators do not support one or more of setting and cancelling Call Forwarding by ISDN Line functions.



Customising Your Phone

- 4.1.3 Customising the Buttons
Create or re-arrange a FWD/DND button.

◆◆ **Call forward to outside line ("Call Forwarding to CO Line, All Calls" and "Call Forwarding to CO Line, No Answer") in accordance with pre-selected CLIP and DDIIMSN numbers**

◆ **To store a pre-selected CLIP or DDIIMSN number**

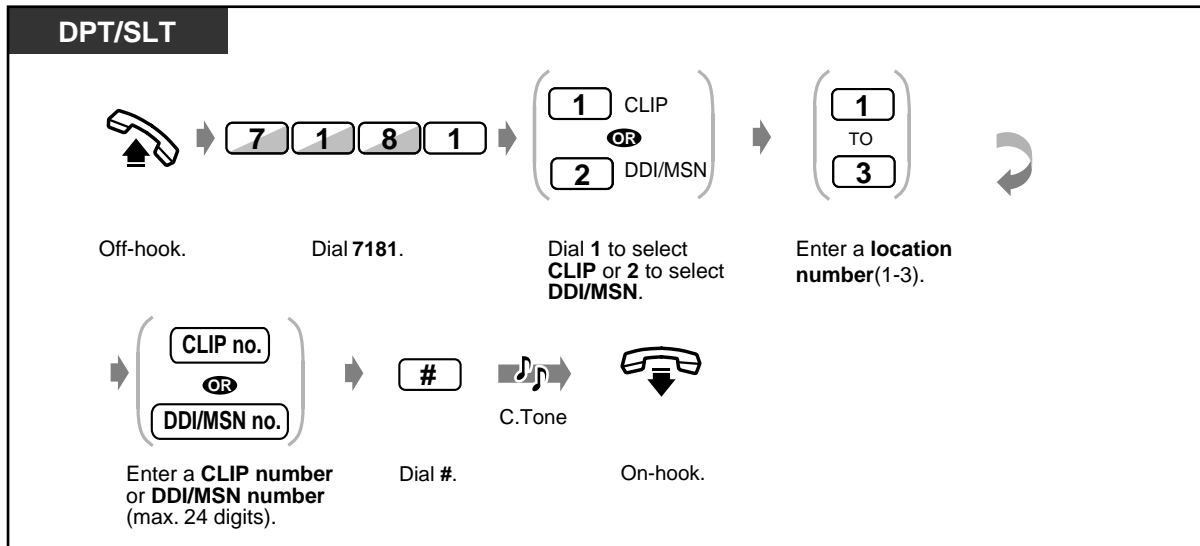

◆ **To delete a pre-selected CLIP or DDIIMSN number**

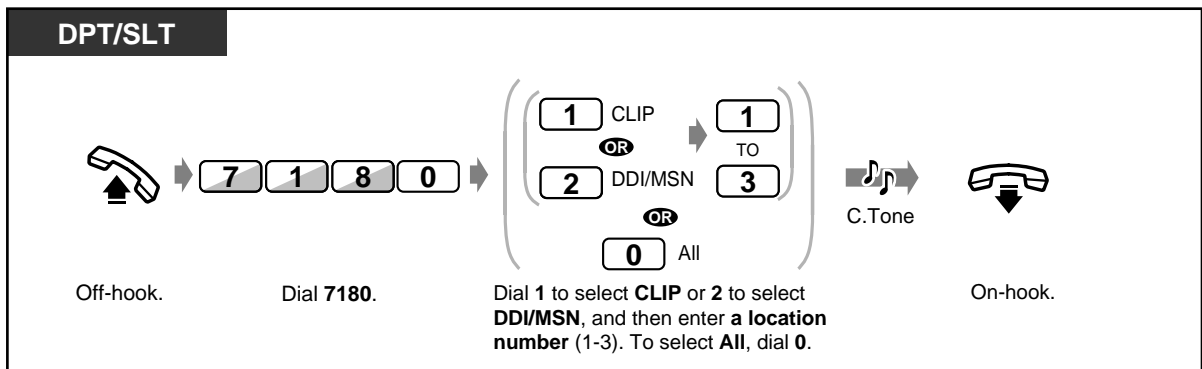

◆ **To confirm a pre-selected CLIP or DDIIMSN number**

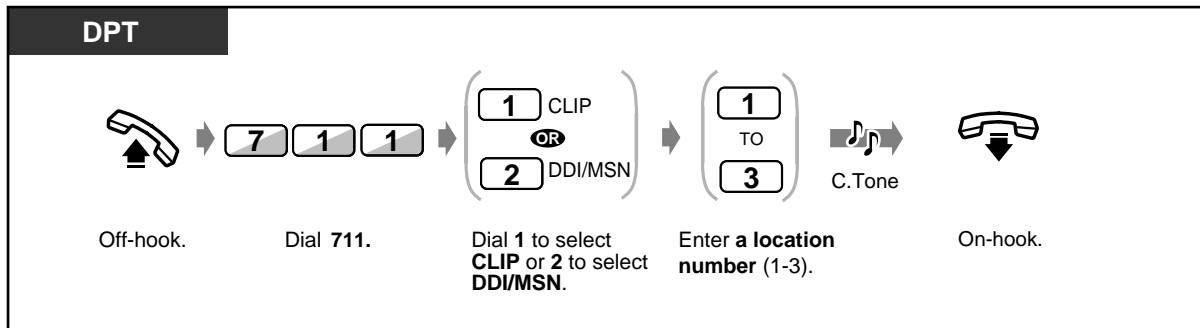

◆ **To activate a pre-selected CLIP or DDI/MSN number**

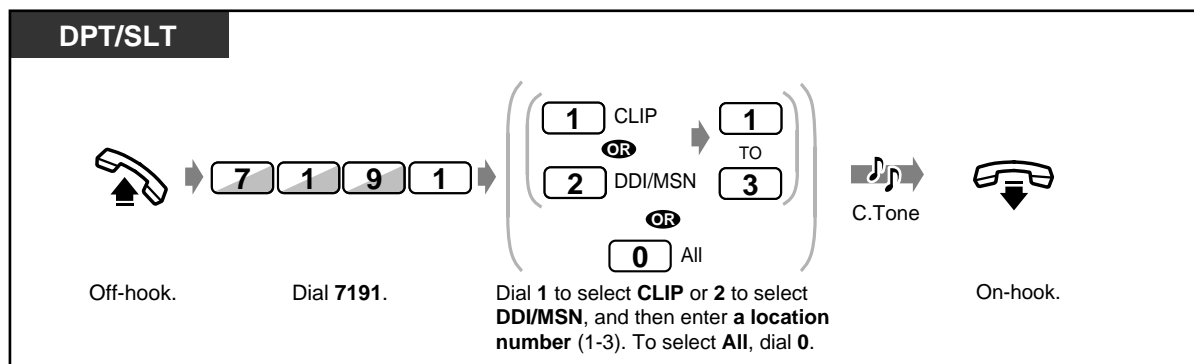

◆ **To cancel an activation of a pre-selected CLIP or DDI/MSN number**

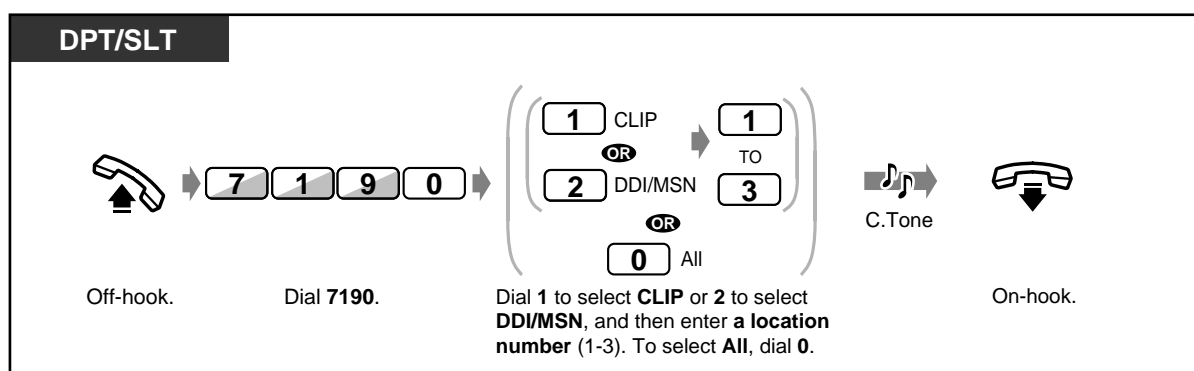

- Up to 3 telephone numbers for each CLIP and DDI/MSN number can be stored per extension.
- You can store a CLIP and DDI/MSN number at any location (1-3) in any order. There is no order of priority among 3 locations.
- Even though a CLIP or DDI/MSN number is stored, this feature will not be enabled unless you activate them.
- This feature is automatically disabled on deleting stored CLIP or DDI/MSN numbers.
- The Call Forwarding to CO Line (All Calls) can be set or cancelled from outside by Direct Inward System Access (DISA) function. Also, it is possible through DISA to store/delete CLIP and DDI/MSN numbers that are allowed to forward and to activate/cancel them. Refer to 2.2.8 To Access Another Party Directly from Outside (Direct Inward System Access [DISA]).
- Call forward to outside line in accordance with pre-selected CLIP and DDI/MSN numbers is not available when receiving a call from an analogue CO line. Even when a stored CLIP or DDI/MSN number is activated, call forwarding to CO line (All Calls/No Answer) will function according only to the setting as described in "Setting or cancelling the Call Forwarding features" above.

2.6.3 Forwarding Calls from a Hunting Group

Pre-assigned extension users can forward calls arriving at any hunting group or calls arriving just at your own hunting group. The destination can be another hunting group or a specific extension. Some extensions may be restricted.

Hunting Group

A hunting group is a group of extensions organised in such a way that if the first destination is busy, the next destination is hunted until an idle destination is found. The order (hunting type) is assigned in a system programming. Consult your manager.

Extension Group (for your reference)

An extension group is used for group paging and group pickup features. An extension can belong to several extension groups.

◆ **To set**

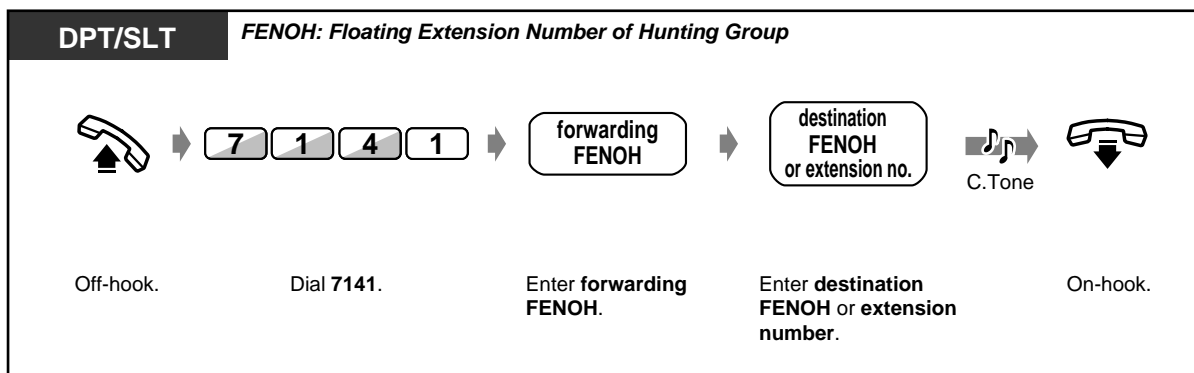

◆ **To cancel**

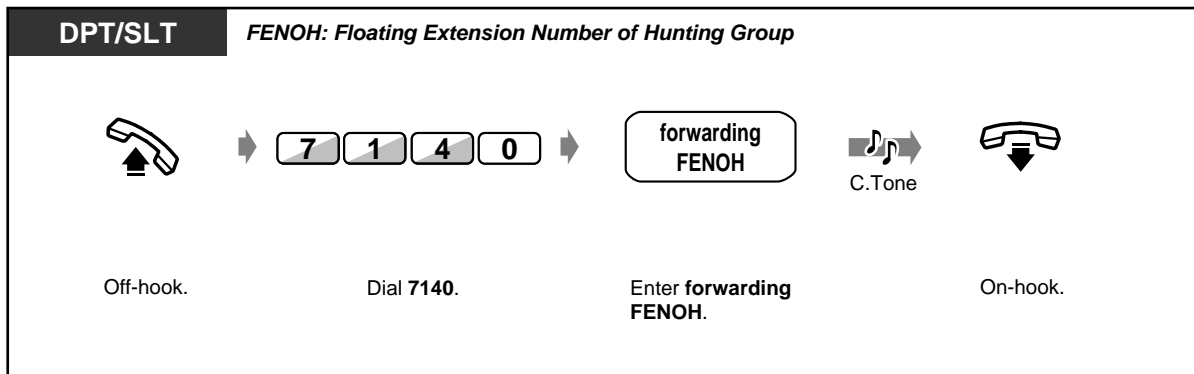



- You can set or cancel this feature by simply pressing the Call Forwarding from Hunting Group button. If set, the button light turns red.
- Each call can be forwarded up to 4 times. The fifth time will be disregarded.

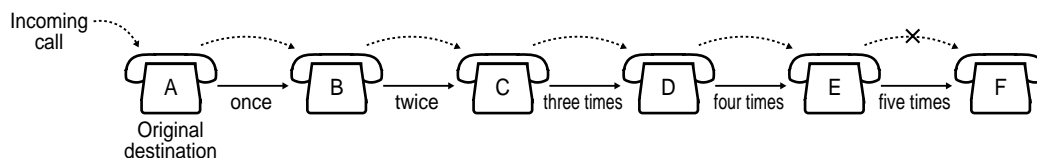

- **Boss-secretary function**
The destination extension can call the forwarding group.

<Example>

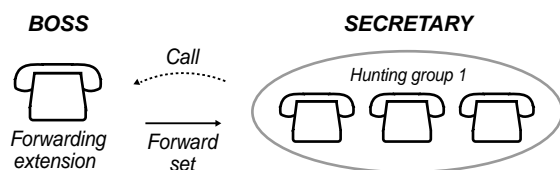

- The "Forwarding Calls from a Hunting Group" button toggles this feature, and shows the current status as follows:
off: Forwarding off
Red on: Forwarding on



Customising Your Phone

- 4.1.3 Customising the Buttons
Create or re-arrange a Call Forwarding from Hunting Group button.

2.6.4 Showing an Absent Message on the Caller's Telephone Display (Absent Message Capability)

You can show the reason for your absence, if the calling extension uses a Panasonic digital proprietary telephone with a display. This way the caller will know when you will be available. You can choose 1 of 9 messages.

Message no.	Default Message
1	Will Return Soon
2	Gone Home
3	At Ext %%% (Extension number)
4	Back at %:% (Hour:Minute)
5	Out Until %/% (Date)
6	In a Meeting
7	
8	
9	



- Enter the desired value in the "%" space.
You must make your message in all of the "%"s using 0 to 9, #, or *.
- The messages can be changed. Consult your dealer.

◆ To Set

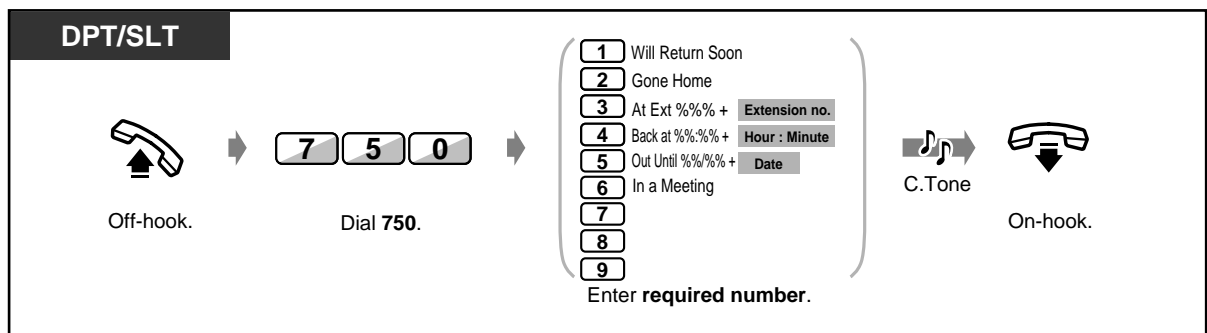

T7431

Press **MODE** until "Feature Access" is displayed.

Rotate **Jog Dial** until "ABST MSG On" is displayed.

Press **SELECT**.

Enter **required number**.

C.Tone

On-hook.

T7433

Press **SHIFT** until "FEAT" is displayed.

Press "FEAT".

Rotate **Jog Dial** until "ABST MSG On" is at the arrow.

Press "SEL".

Enter **required number**.

C.Tone

On-hook.

T7436/T7235

Press "Features".

Rotate **Jog Dial** or press "NEXT" until the following is displayed.

Press "Absent MSG On (1-9)".

Enter **required number**.

C.Tone

On-hook.

◆ **To cancel**

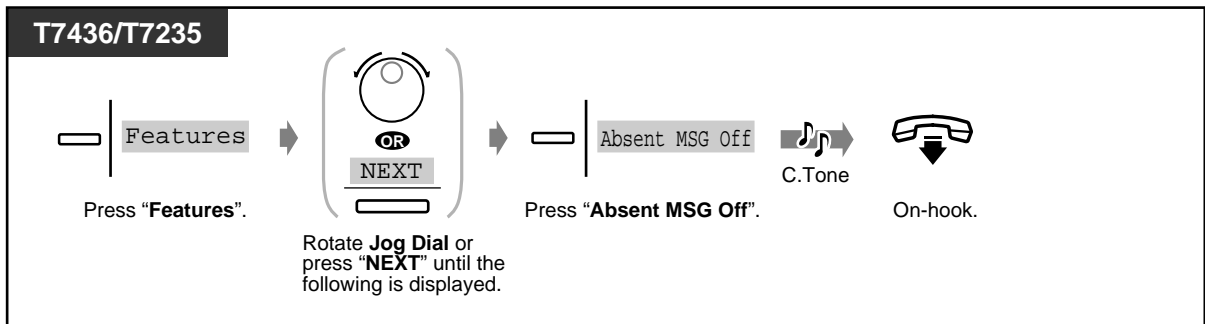
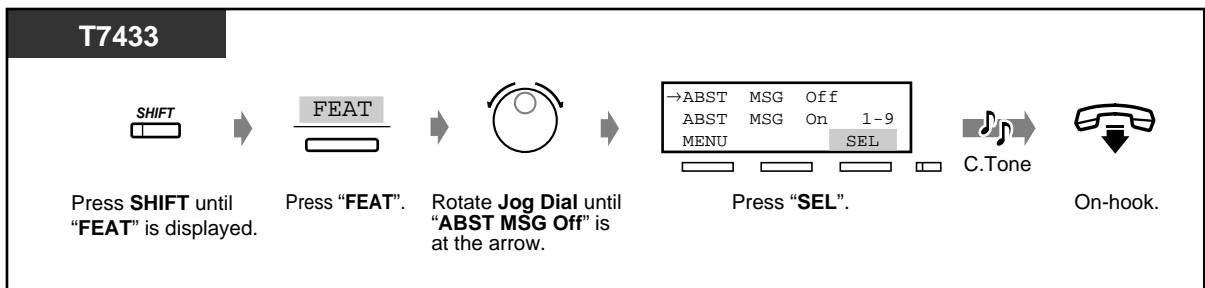
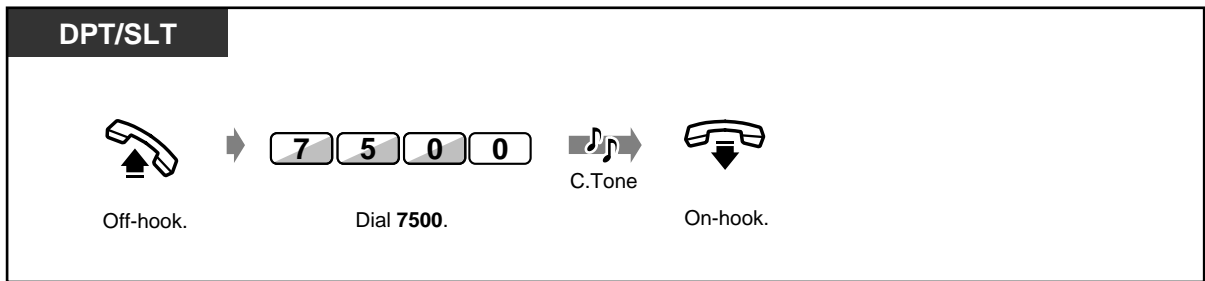

- **To confirm the message**, go off-hook. It will be displayed. However, if "Voice Msg Full" is displayed because the total recording time of your Built-in Voice Message resource becomes less than 5 minutes, none of the absent messages will be displayed on the calling extension when going off-hook, even if you have set an absent message.

2.6.6 Leaving a Hunting Group (Log-In/Log-Out)

You can set your status in a hunting group. Set Log-Out when you leave the office so that incoming calls will temporarily skip your extension in the hunting type. When you return, set Log-In so that calls will reach your extension. (Default: Log-In)

Hunting Group

A hunting group is a group of extensions organised in such a way that if the first destination is busy, the next destination is hunted until an idle destination is found. The order (hunting type) is assigned in a system programming. Consult your manager.

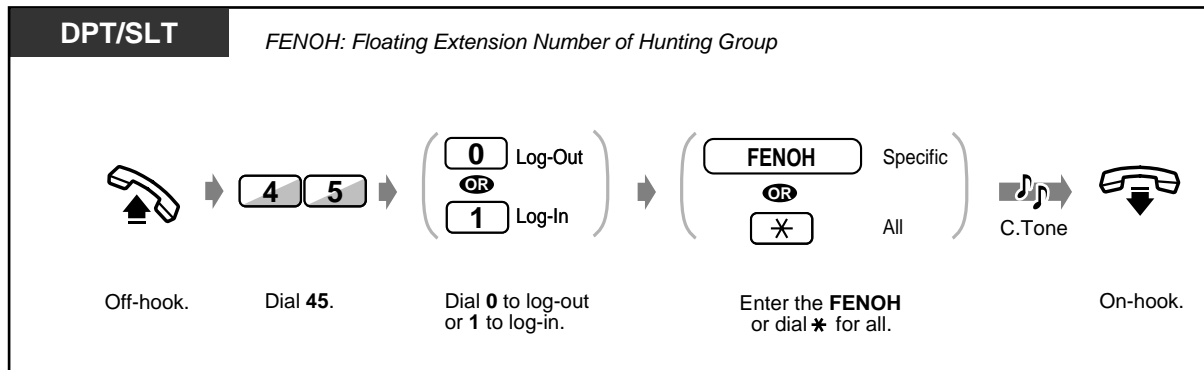
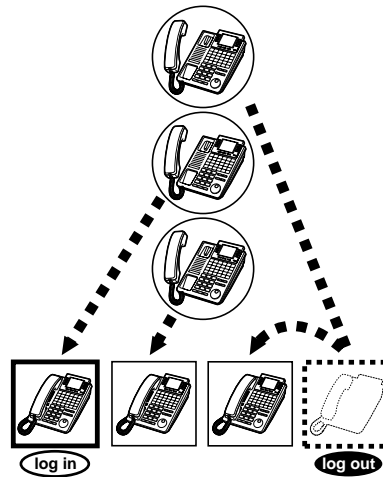

- The Log-In/Log-Out button alternates the setting between Log-In and Log-Out modes. The button light shows the current status as follows:
 - Off:** Log-In mode
 - Red on:** Log-Out/Other use
 - Flashing red:** a call waiting



Customising Your Phone

4.1.3 Customising the Buttons

Create or re-arrange a Log-In/Log-Out button.

2.7 Making/Answering an Announcement

2.7.1 Paging

You can make a voice announcement to several people at the same time. Your message is sent over the digital proprietary telephone speakers and/or external speaker. The paged person can answer your paging from any telephone.

Extension Group

An extension group is used for group paging and group pickup features. An extension can belong to several extension groups.

There are 3 types as shown below:

All:

Paging through both the telephone speakers and external speaker.

External:

Paging through the external speaker.

Group:

Paging to a particular extension group or all groups (all extensions) through the telephone speakers.

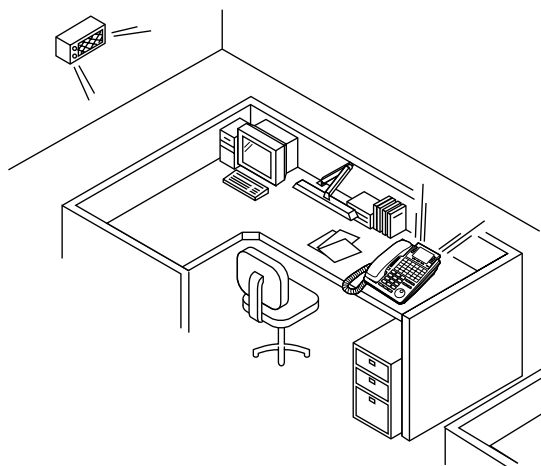

◆ All

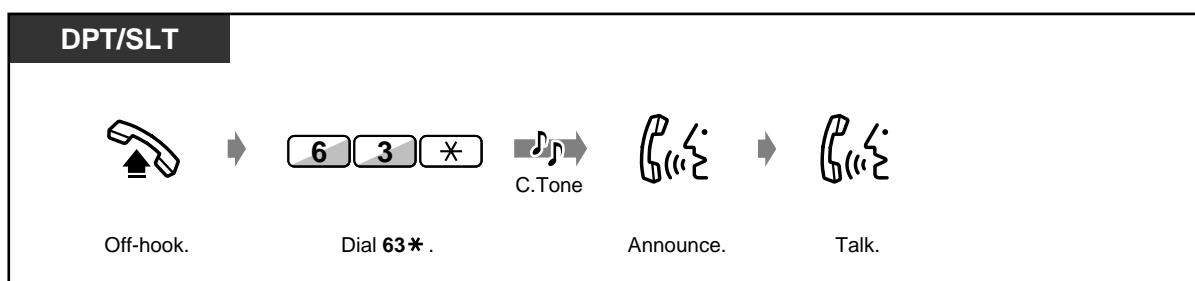

◆ External

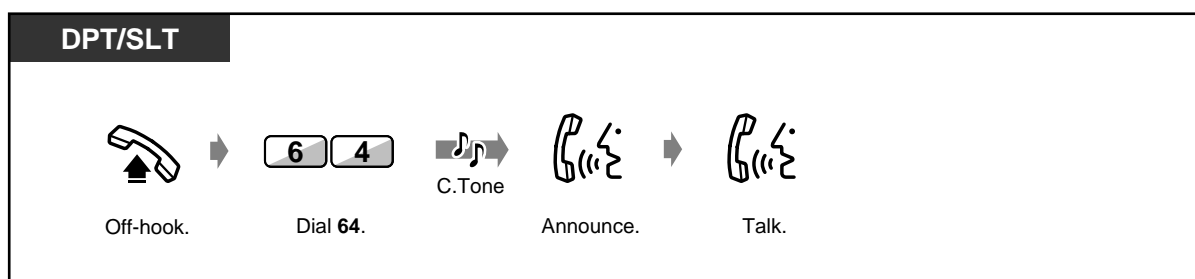

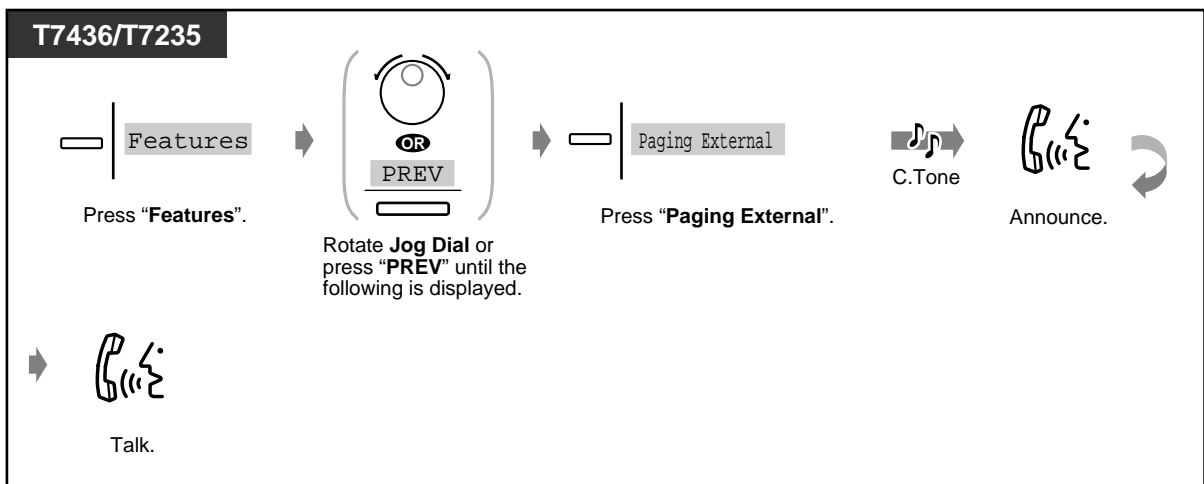
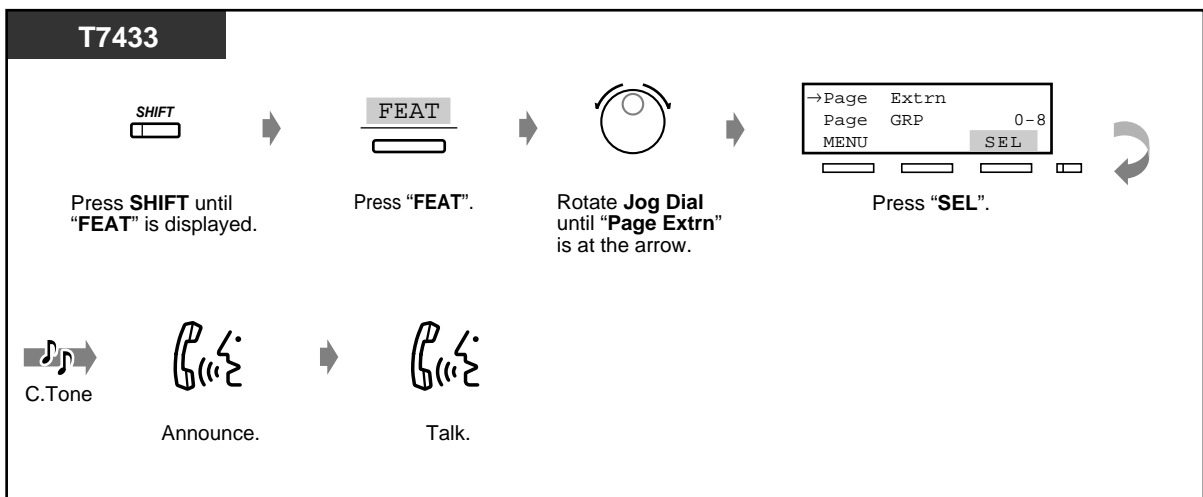
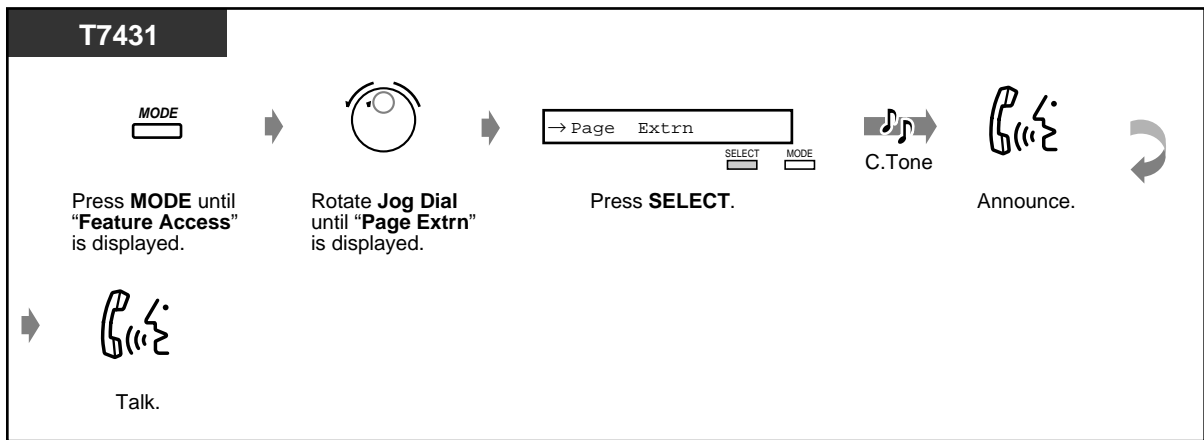

◆ **Group**

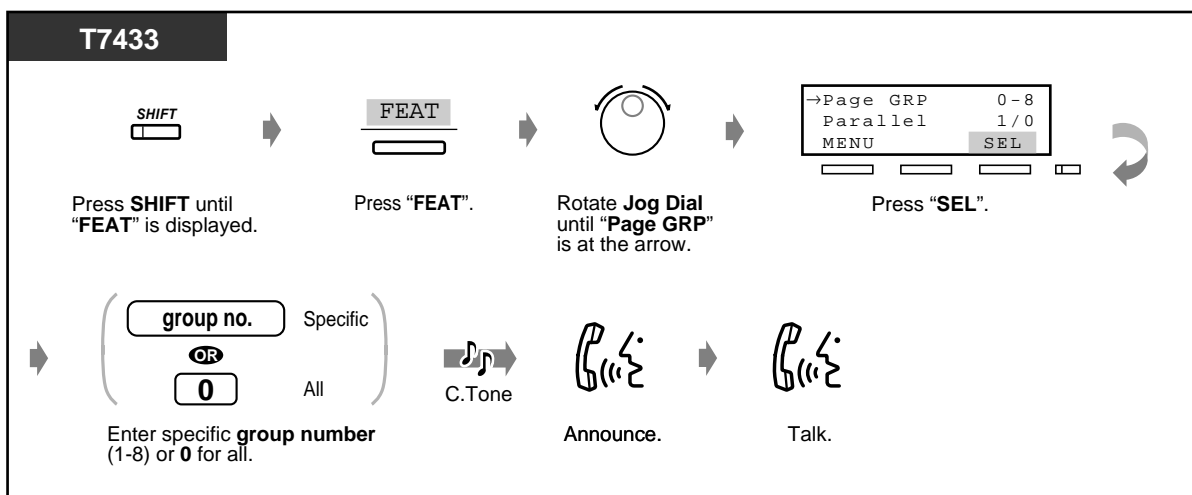
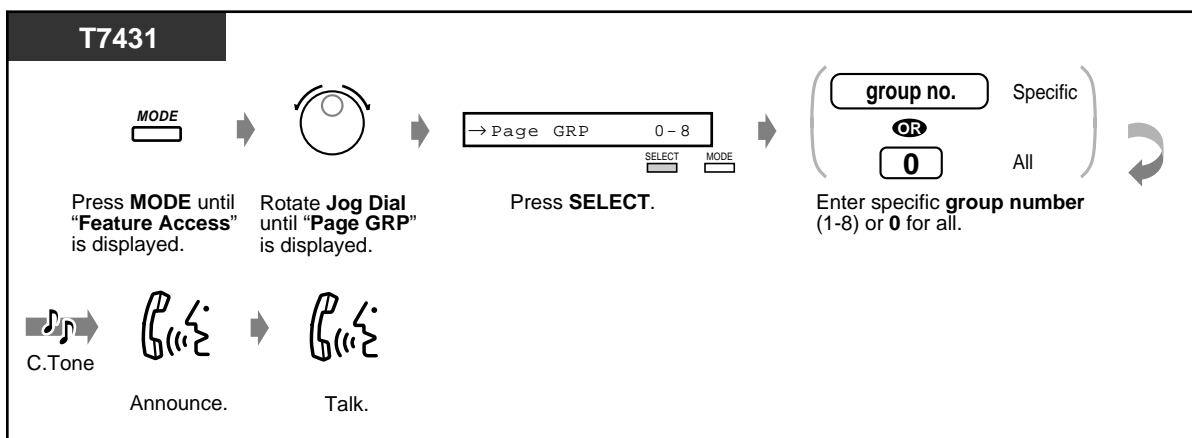
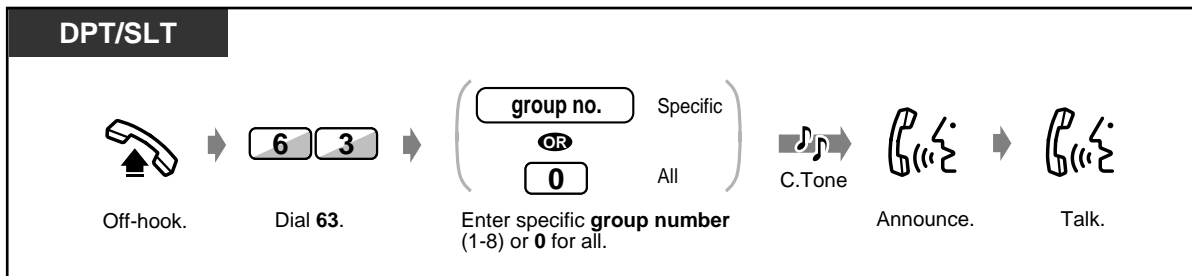

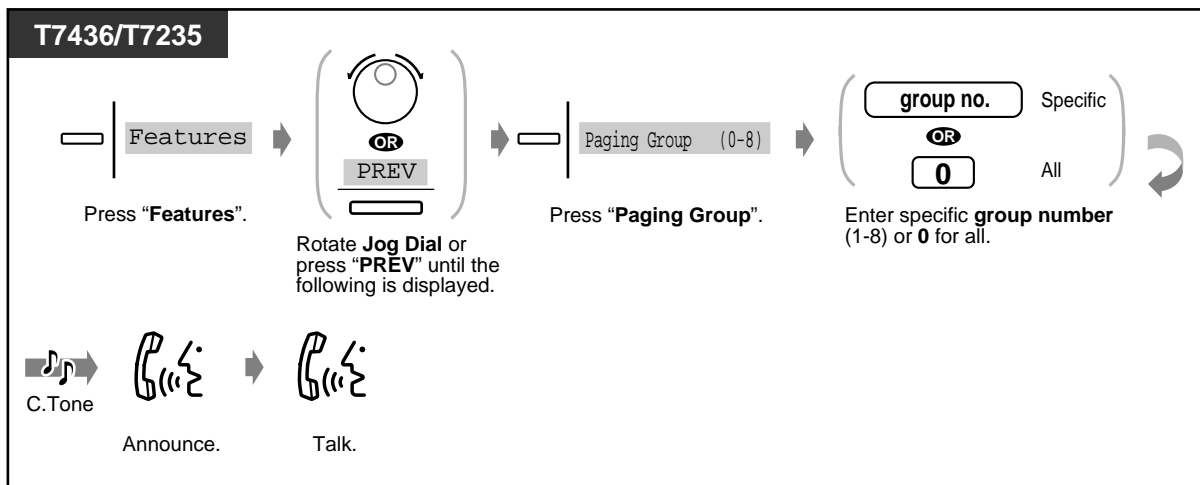

- A ringing, busy, or a single line telephone cannot receive a paged announcement.
- The digital proprietary telephone user can deny a paged announcement. For more details, refer to 2.8.4 Denying the Paged Announcement (Paging — DENY).

2.7.2 Paging a Person and Transferring a Call

◆ Through a speaker and telephones

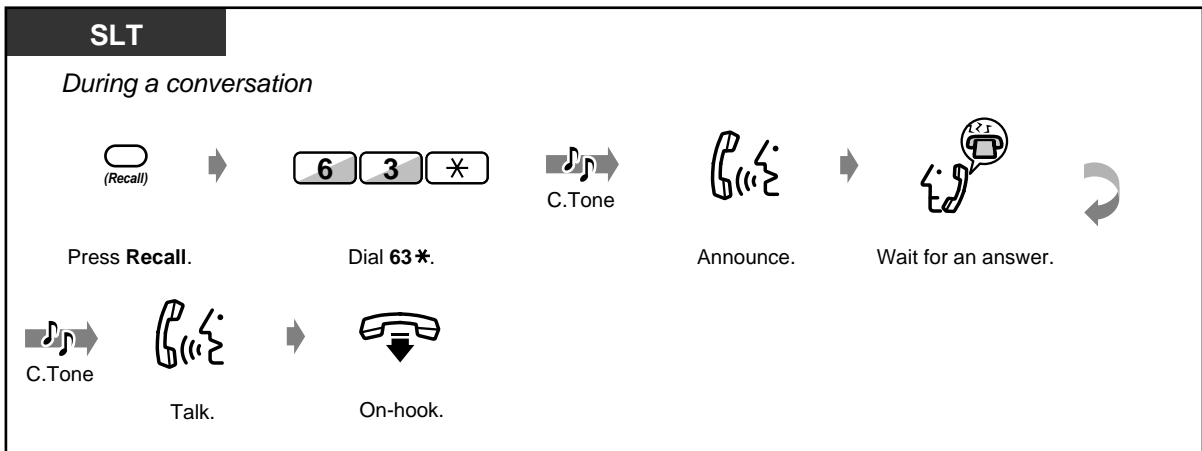
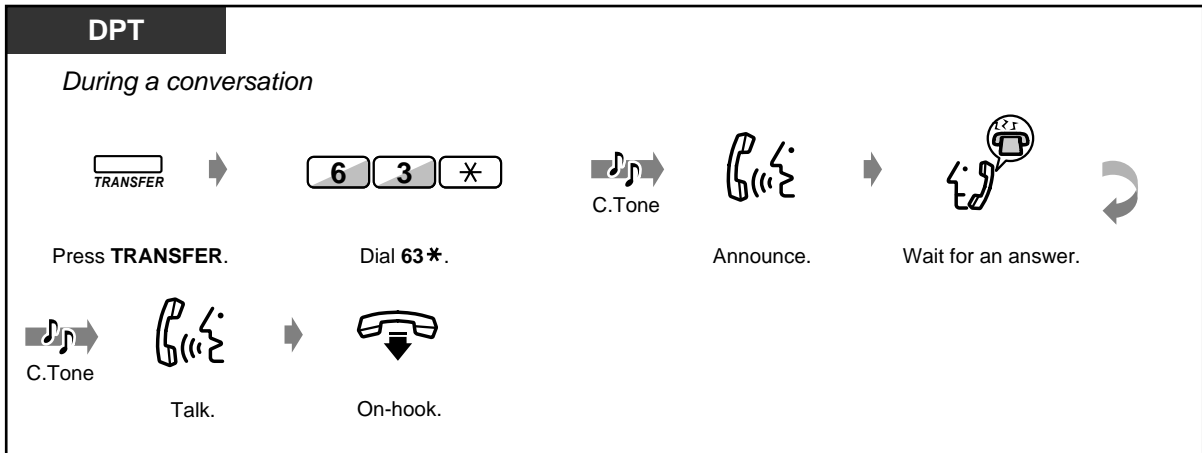

◆ Through a speaker

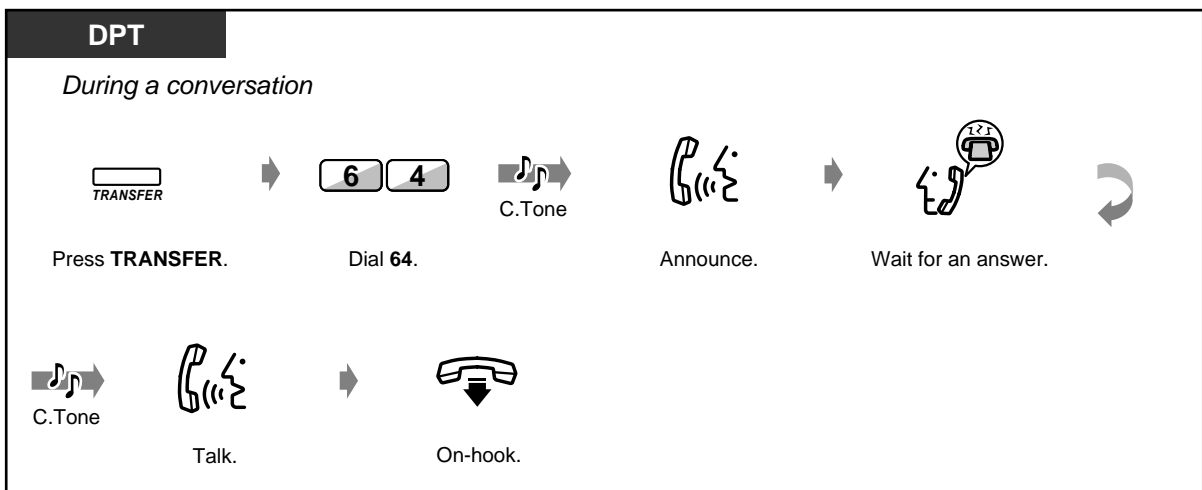

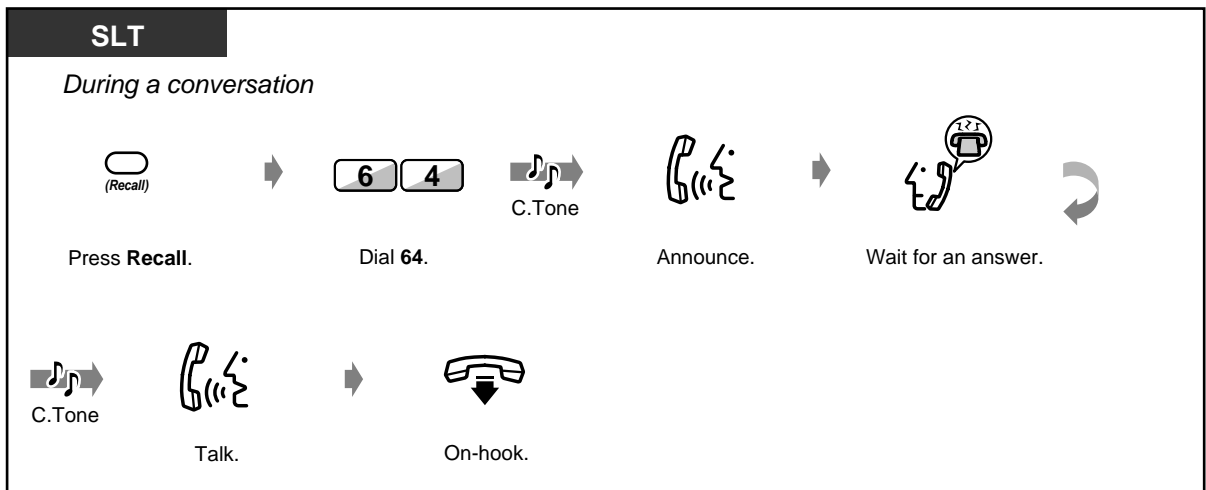

◆ **Through the telephones of a particular extension group**

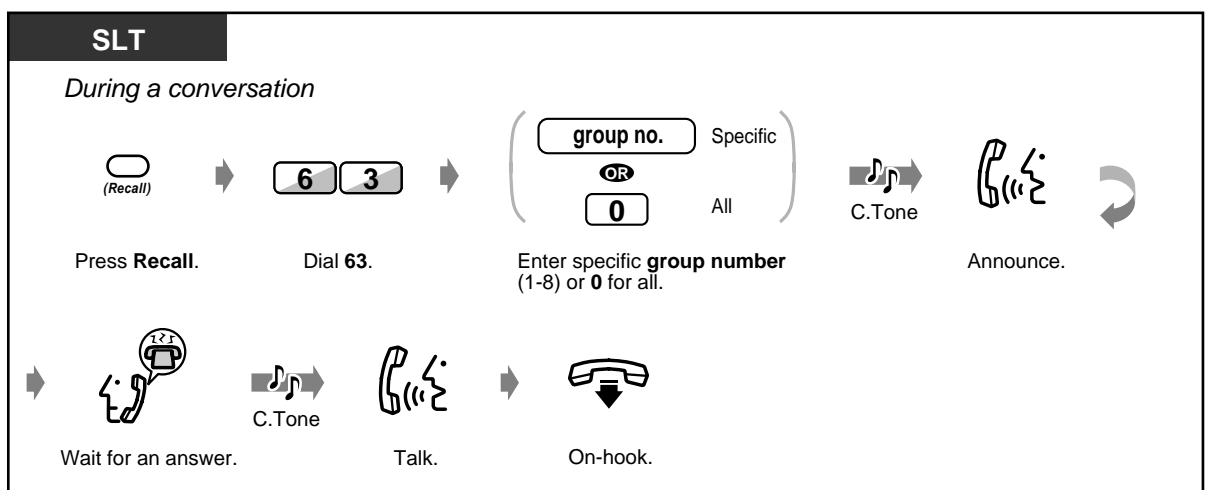
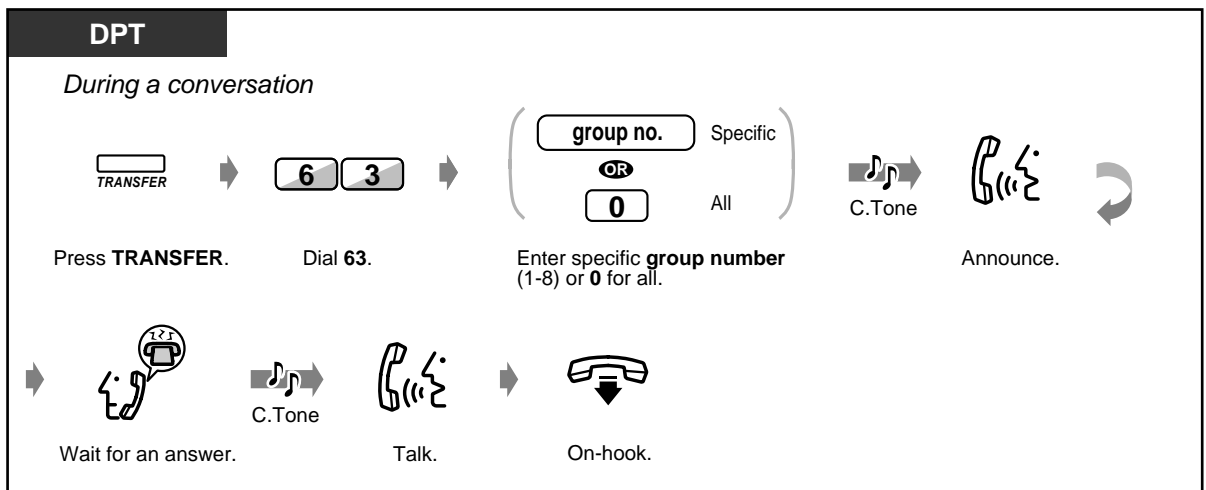

2.7.3 Answering a Paged Announcement

◆ Through a speaker

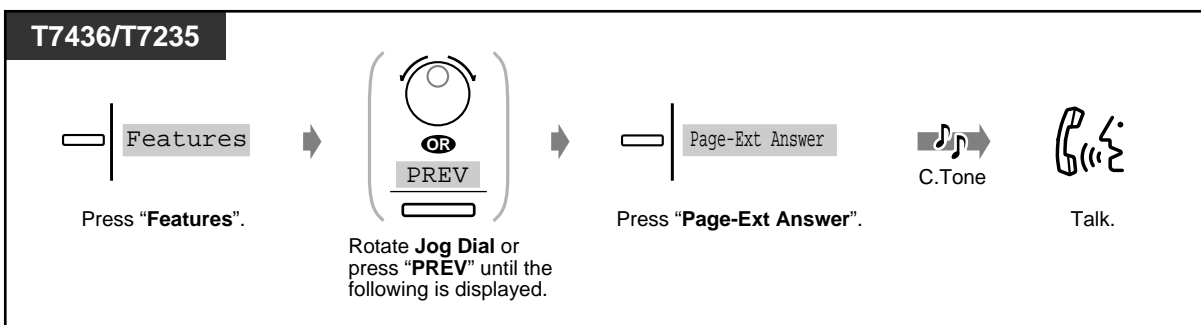
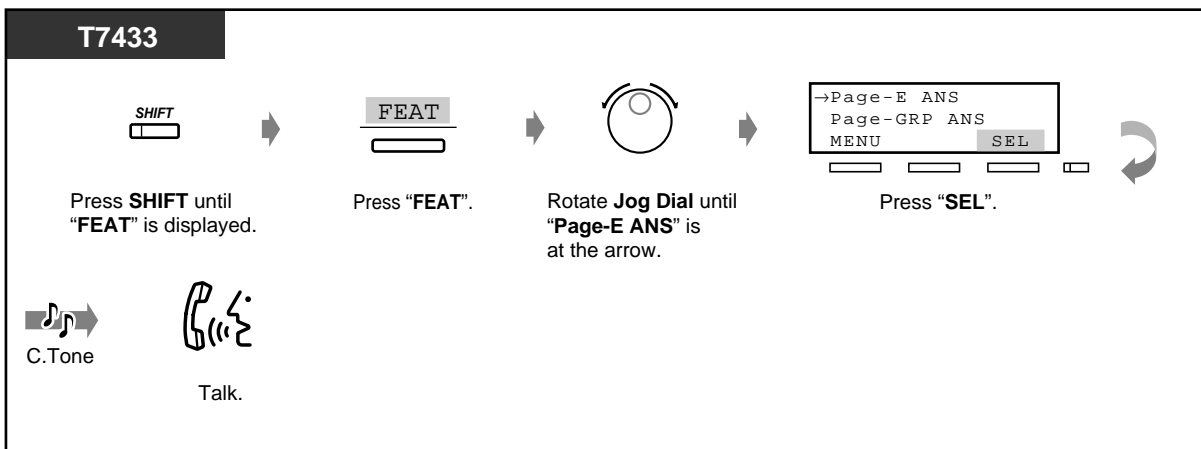
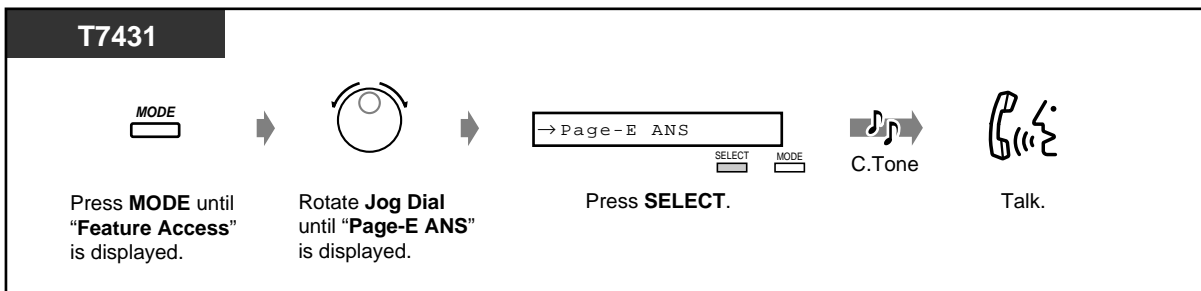
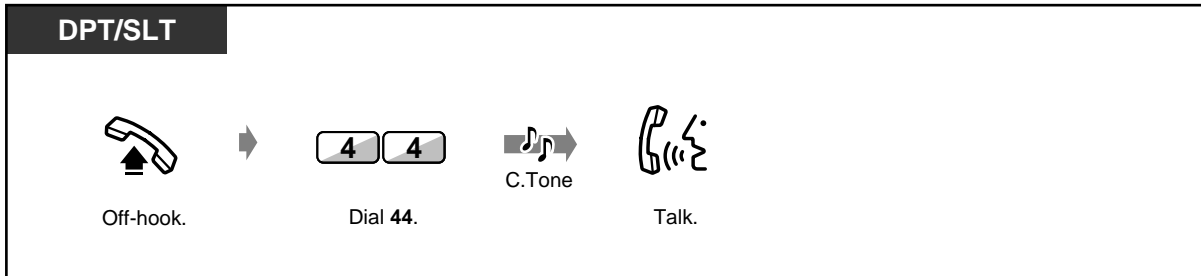

◆ **Through the telephones**

DPT/SLT

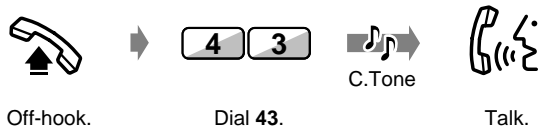

Off-hook. Dial 43. C.Tone Talk.

T7431

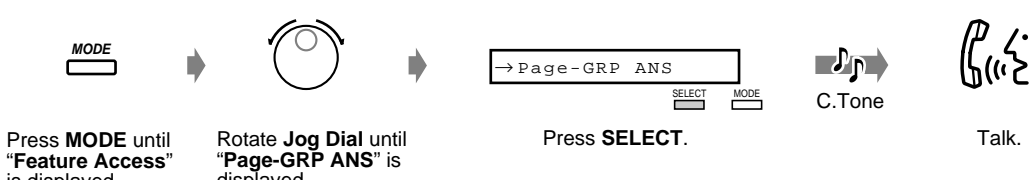

Press **MODE** until "Feature Access" is displayed. Rotate **Jog Dial** until "Page-GRP ANS" is displayed. Press **SELECT**. C.Tone Talk.

T7433

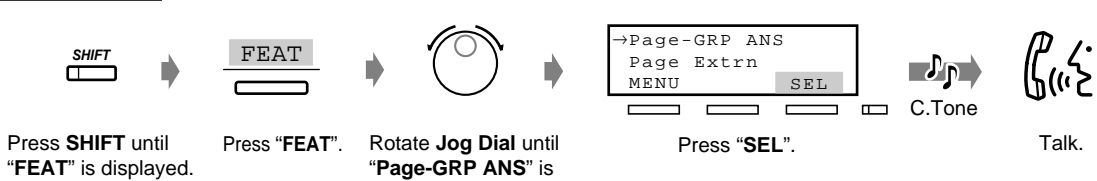

Press **SHIFT** until "FEAT" is displayed. Press "FEAT". Rotate **Jog Dial** until "Page-GRP ANS" is at the arrow. Press "SEL". C.Tone Talk.

T7436/T7235

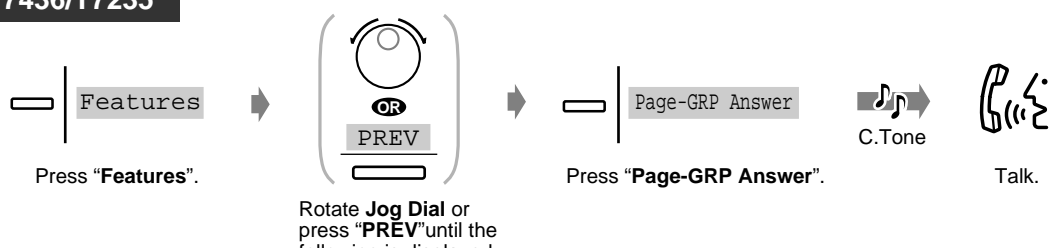

Press "Features". Rotate **Jog Dial** or press "PREV" until the following is displayed. Press "Page-GRP Answer". C.Tone Talk.

2.8 Setting the Telephone According to Your Needs

2.8.1 Setting the Alarm (Timed Reminder)

You can receive a ringing alarm at your telephone to remind you of a meeting, appointment or as a wake-up call. The setting can be for either one time or daily (every day until cancelled) at a pre-set time. You can record Timed Reminder outgoing messages (OGM). Refer to 2.6.1 Built-in Voice Message.

◆ **To set**

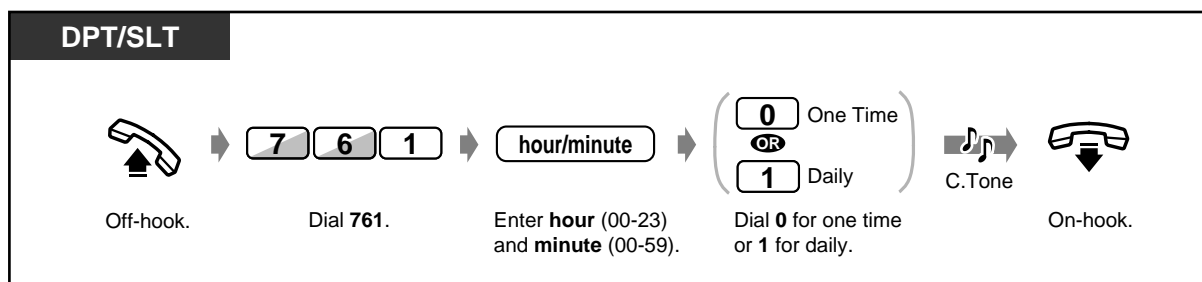

◆ **To cancel**

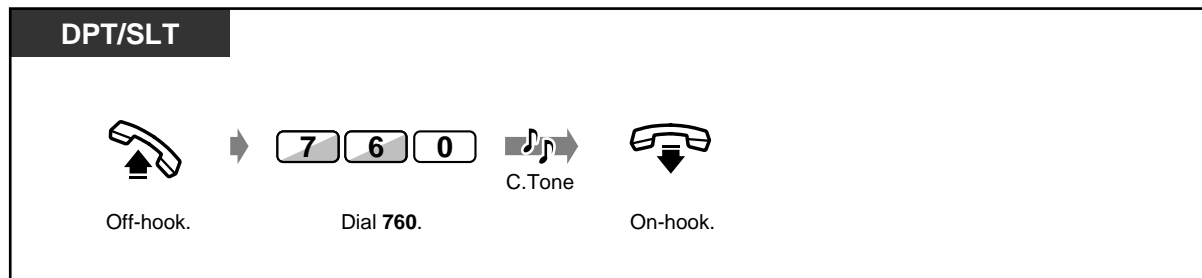

◆ **To view the setting**

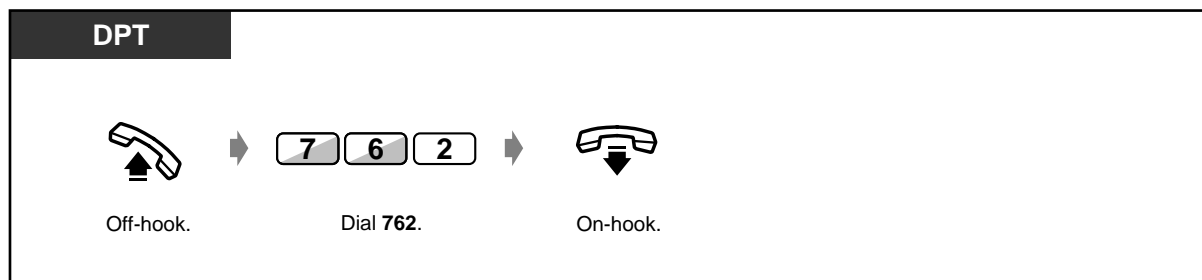

◆ **To stop or answer the ringing**

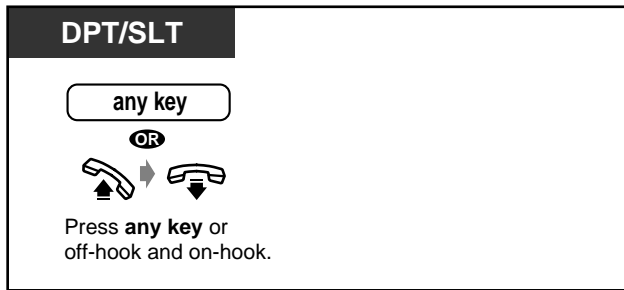

- **If you are having a telephone conversation during the pre-set time**, the ringing will start after going on-hook.
- If you go off-hook to answer, you can hear the recorded message. (Timed Reminder OGM)
- If you set this function without recording an OGM, you will hear dial tone 3 at a pre-set time, if you go off-hook to answer the ringing.



When the daily alarm is set, the display shows "×" in the corner.

Alarm 10:10*

2.8.2 Refusing Incoming Calls (Do Not Disturb [DND])

— Refusing all calls

— Refusing direct outside calls

◆◆ Refusing all calls

You may set this feature during a meeting or when you are busy. Outside calls can be forwarded to a backup station (pre-assigned extension or the operator).

◆ To set

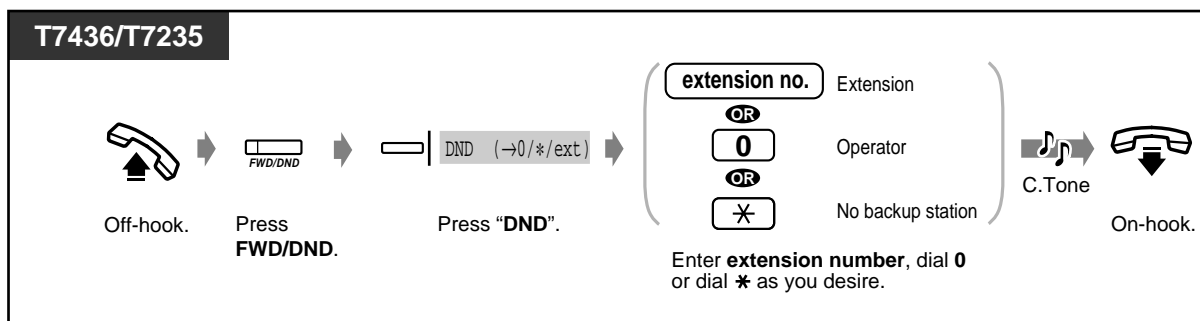
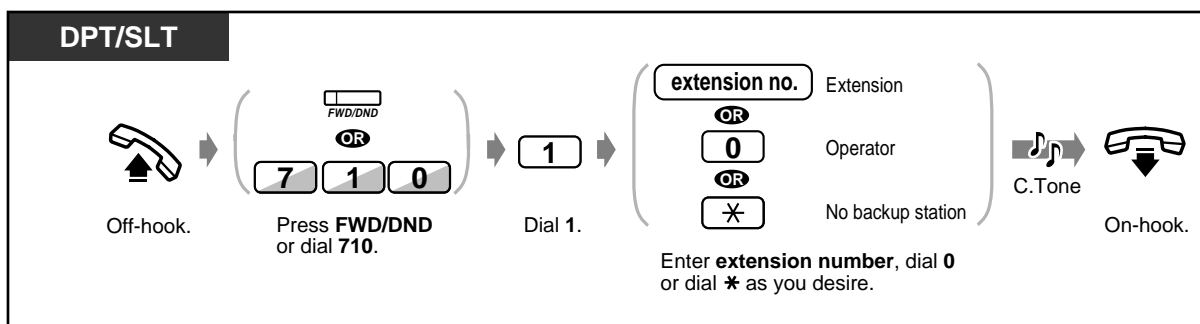

◆ To cancel

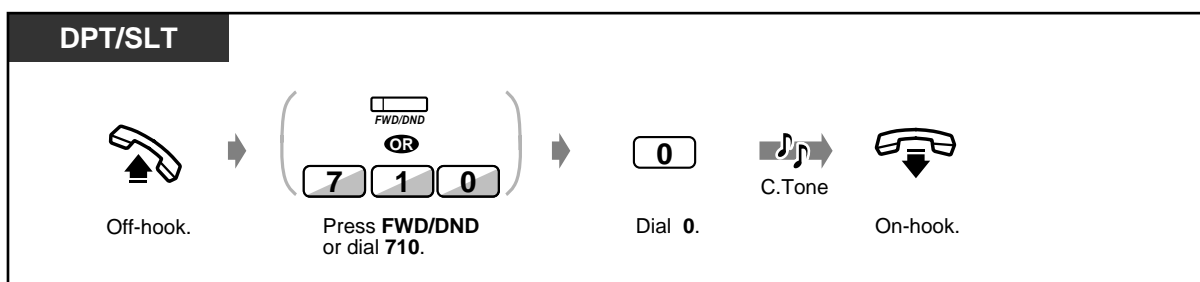

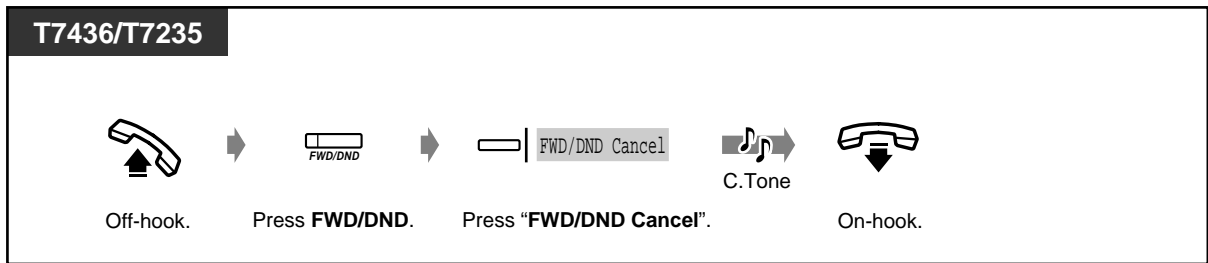

◆◆ **Refusing direct outside calls (DND for Intelligent Call Handling 1:1 Call)**

You can set your extension to refuse direct outside calls and have them forwarded to the operator. The operator cannot set this feature.

◆ **To set/cancel**

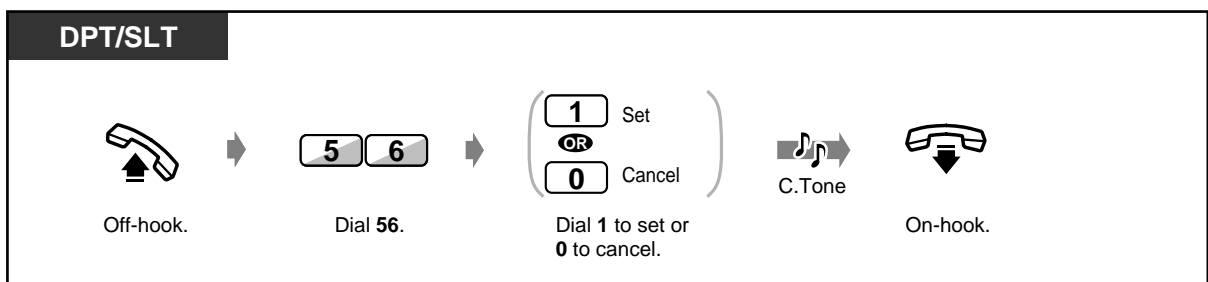

- If an incoming call through Direct Inward System Access (DISA) comes in to an extension that has set DND (Outside calls are forwarded to a pre-assigned extension), the call will be directed to the Operator.
- A flashing CO button tells you an outside call is received. You can answer the call by pressing the CO button.
- The following button lights turn red when the DND feature is set.
Your FWD/DND button.
The DSS button on other extensions where your extension number has been assigned.
- The following features cannot be set at the same time.
Forwarding your calls (Call Forwarding)
Refusing all calls (Do Not Disturb [DND])
Refusing direct outside calls (DND for Intelligent Call Handling 1:1 Call)
The most recent feature set overrides the previous setting.
- You can set or cancel the DND for Intelligent Call Handling 1:1 Call feature by simply pressing the DND for Intelligent Call Handling 1:1 Call button. If set, the button light turns red.

Customising Your Phone

- 4.1.3 Customising the Buttons
Create or re-arrange a FWD/DND button.

2.8.3 Receiving a Call Waiting (Call Waiting/Off-Hook Call Announcement [OHCA]/Whisper OHCA)

During a conversation, you can be informed a call waiting with a tone or voice announcement through your speaker or handset (default: No tone).

Call waiting tone:

a waiting tone through the handset. You can change the tone (refer to 4.1.2 Initial Settings).

OHCA:

a voice announcement through the speaker without pre-information (KX-T7436 and KX-T7235 telephone users only).

Whisper OHCA:

a voice announcement through the handset without pre-information (KX-T7400 series telephone users only).

◆ To set/cancel

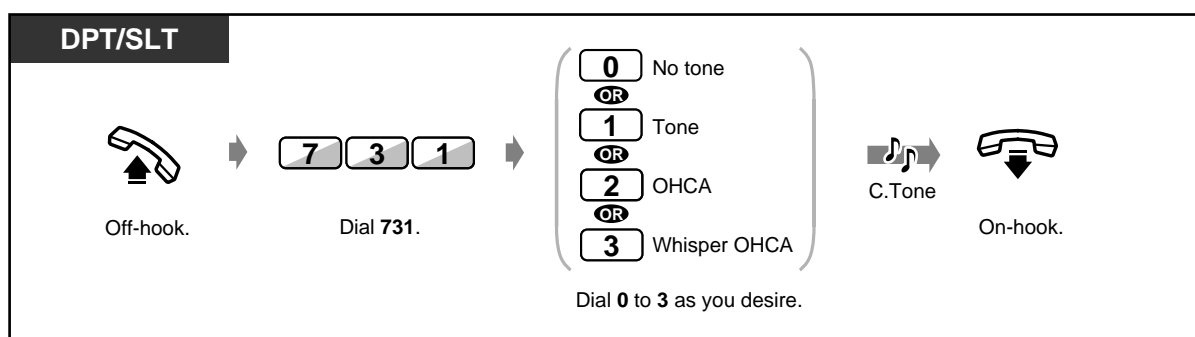

- You can set or cancel the Call Waiting features by simply pressing the Call Waiting button. Pressing this button changes the features as follows:



If the Call Waiting tone, OHCA or Whisper OHCA is selected, the button light turns red.

- To answer a Call Waiting, refer to 2.4.7 Answering a Call Waiting.



Customising Your Phone

- 4.1.3 Customising the Buttons
Create or re-arrange a Call Waiting button.

2.8.4 Denying the Paged Announcement (Paging — DENY)

You can refuse any paged announcement sent through your speaker.

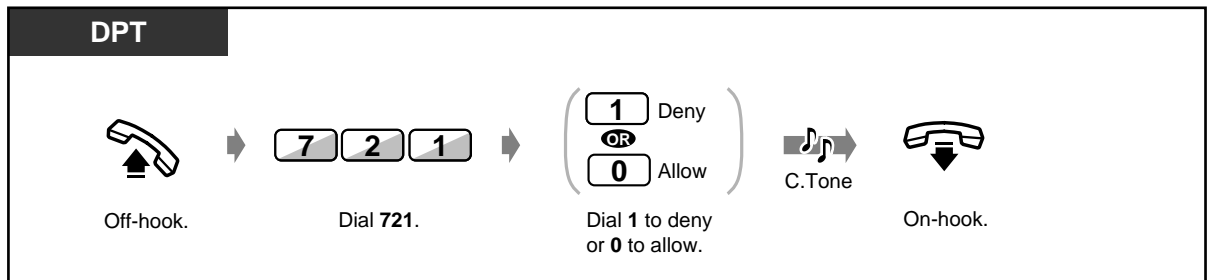

- You can deny or allow this feature by simply pressing the Paging Deny button. If denied, the button light turns red.



Customising Your Phone

- 4.1.3 Customising the Buttons
Create or re-arrange a Paging Deny button.

2.8.5 Automatic Selection of Calling/Connected Line Identification Presentation (CLIP/COLP)

— Presenting CLIP/COLP assigned per a group of System Speed Dialling and Intelligent Call Handling number

— Presenting CLIP/COLP assigned per a ISDN (BRI) port

Automatically selects the pre-assigned CLIP/COLP number on the opposite party's display. You can assign 2 CLIP numbers and 2 COLP numbers per a group of CLIP/COLP assignment table, or per an ISDN port. One number is for business and other is for private.

CLIP :

When making a call, you can let the other party see your pre-assigned identification number.

COLP :

When receiving a call, you can let the party calling you see your pre-assigned identification number.

The selection of CLIP/COLP per an ISDN port is prior to the selection of CLIP/COLP per a group of System Speed Dialling and Intelligent Call Handling number.

◆◆ Presenting CLIP/COLP assigned per a group of System Speed Dialling and Intelligent Call Handling number

You can present your CLIP or your COLP for the parties that phone numbers are stored in System Speed Dialling and Intelligent Call Handling (SSD and ICH) table. There are up to 7 CLIP/COLP group numbers (0-6) that are based on 100-segment of SSD and ICH table. For example, when making a call to Ms. A, that phone number is stored at SSD and ICH table 000, you can present one of the CLIP numbers (business or private) assigned in group number 0. When receiving a call with your DDI/MSN number stored at SSD and ICH table 500, one of the COLP numbers assigned in group 5 will be presented.

Directory

SSD and ICH number		Group no.		Your CLIP no.	Your COLP no.
SSD and ICH	000 — 099	0	Business	-----	-----
			Private		
SSD and ICH	100 — 199	1	Business	-----	-----
			Private		
SSD and ICH	200 — 299	2	Business	-----	-----
			Private		
SSD and ICH	300 — 399	3	Business	-----	-----
			Private		
SSD and ICH	400 — 499	4	Business	-----	-----
			Private		
DDI/MSN and ICH	500 — 599	5	Business	Not applicable	-----
			Private		
DDI/MSN and ICH	600 — 699	6	Business	Not applicable	-----
			Private		

◆ To select CLIP/COLP

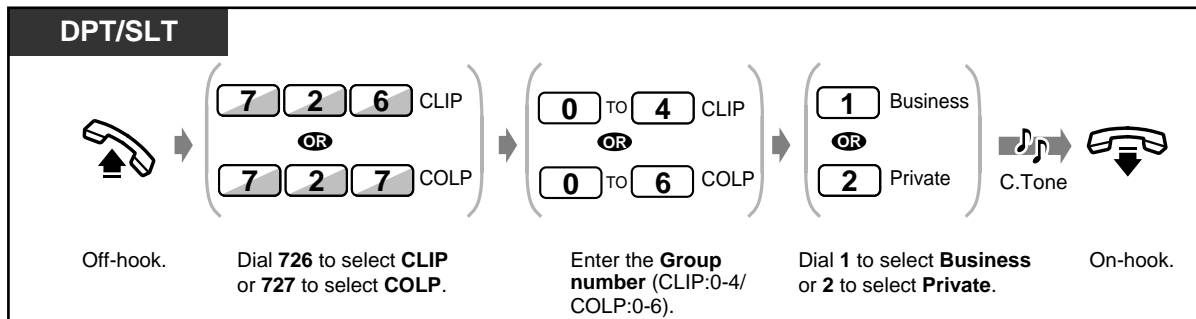

- The number displayed on the opposite party's telephone is assigned by system programming. Please ask your manager about this number.
- If you make an outside call without using SSD feature, the first CLIP assigned at Group 0 will be displayed on the opposite party's telephone.

◆◆ Presenting CLIP/COLP assigned per an ISDN (BRI) port

You can present your CLIP or your COLP for the parties on a port basis. You can assign 2 CLIP and 2 COLP numbers for each port.

Directory

Port no.		Your CLIP no.	Your COLP no.
1	Business		
	Private		
2	Business		
	Private		
3	Business		
	Private		

◆ To select CLIP/COLP

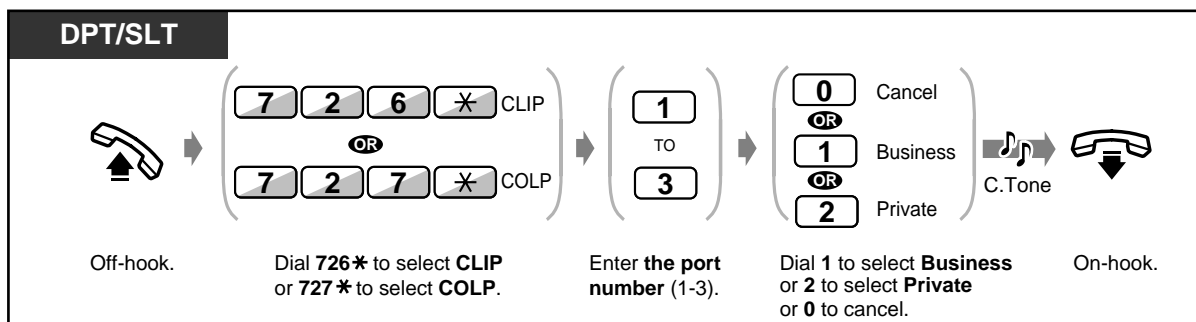



- The number displayed on the opposite party's telephone is assigned by system programming. Please ask your manager about this number.
- If DDI/MSN number not in your contract has been assigned as CLIP/COLP, the number might not be displayed properly.
- Some of the extension may be restricted. Consult your manager.
- CLIP/COLP per an ISDN port is prior to the CLIP/COLP per a group of SSD and ICH number. If CLIP/COLP per an ISDN port is cancelled, the selection of CLIP/COLP per a group of SSD and ICH number is used (default: cancelled).

2.8.6 Preventing Your Number Being Displayed on the Called Party's Telephone (Calling Line Identification Restriction [CLIR])

When making an outside call, you can prevent the other party from seeing your identification number. You can change the setting at any time for a particular call. Availability of this feature depends on the ISDN service of your telephone company.

◆ To set/cancel

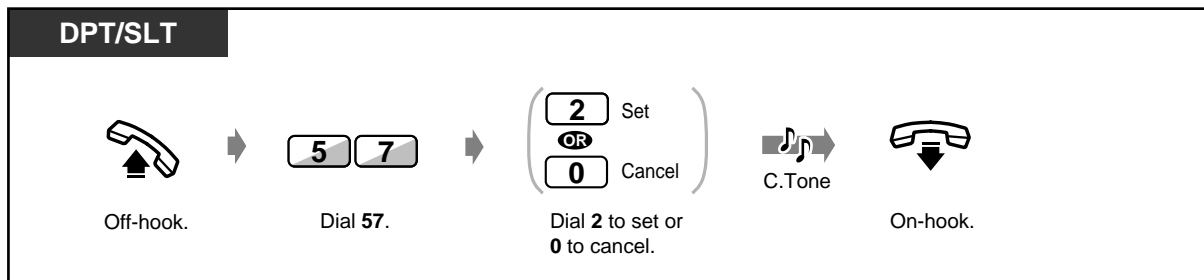

◆ To change the setting at any time for a particular call

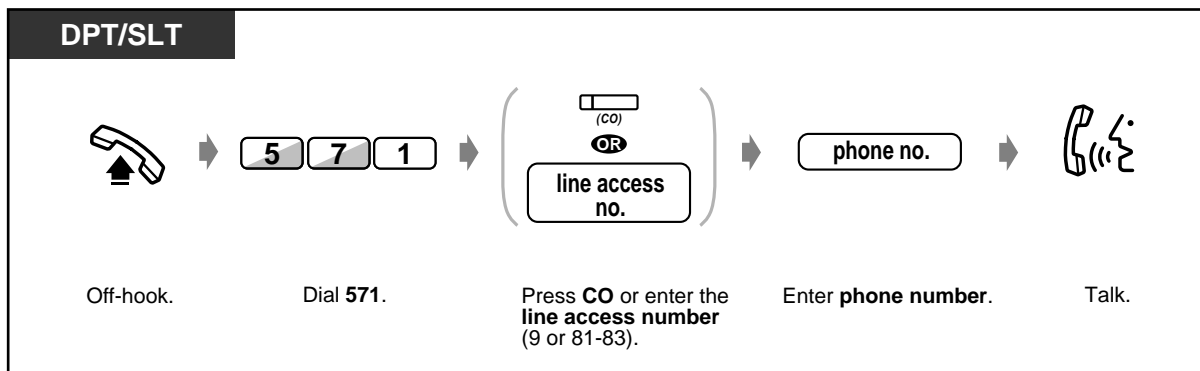

- You can set or cancel this feature by simply pressing the CLIR button. If set, the button light turns red.



Customising Your Phone

- 4.1.3 Customising the Buttons
Create or rearrange a Calling Line Identification Restriction (CLIR) button.

2.8.7 Preventing Your Number Being Displayed on the Calling Party's Telephone (Connected Line Identification Restriction [COLR])

When receiving an outside call, you can prevent the party calling you from seeing your identification number. Availability of this feature depends on the ISDN service of your telephone company.

◆ To set/cancel

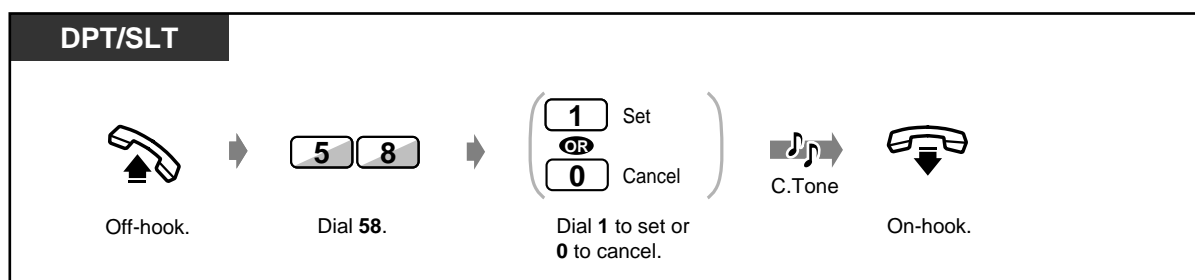

- You can set or cancel this feature by simply pressing the COLR button. If set, the button light turns red.



Customising Your Phone

- 4.1.3 Customising the Buttons
Create or re-arrange a Connected Line Identification Restriction (COLR) button.

2.8.8 Denying Other People the Possibility of Picking up Your Calls (Call Pickup Deny)

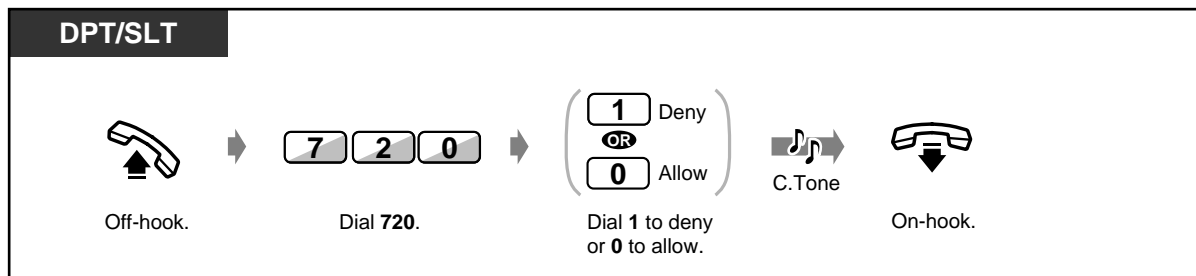

- You can deny or allow this feature by simply pressing the Call Pickup Deny button. If it is denied, the button light turns red.



Customising Your Phone

- 4.1.3 Customising the Buttons
Create or re-arrange a Call Pickup Deny button.

2.8.9 Denying Other People the Possibility of Joining Your Conversation (Executive Busy Override Deny)

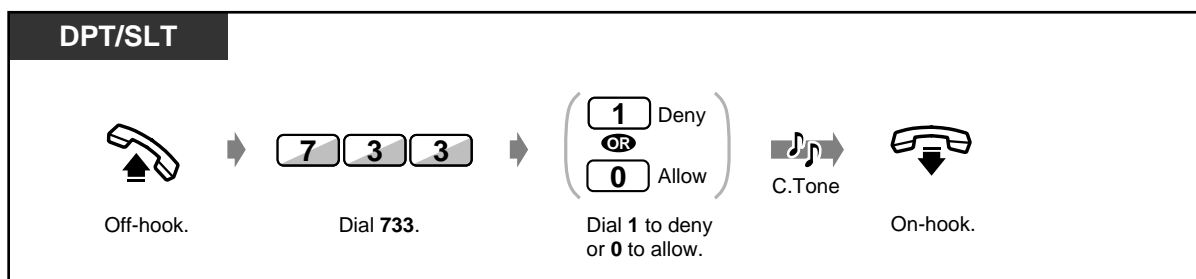

- You can deny or allow this feature by simply pressing the Executive Busy Override Deny button. If denied, the button light turns red.



Customising Your Phone

- 4.1.3 Customising the Buttons
Create or re-arrange a Executive Busy Override Deny button.

2.8.10 Turning on the Background Music

You can listen to background music through your telephone speaker while on-hook. An external music source, such as a radio, must be connected.



◆ To set/cancel

DPT
<i>While on-hook</i>
<input type="checkbox"/> BGM
<input type="checkbox"/>
OR
<i>HOLD</i>
<input type="checkbox"/>
Press " BGM " or HOLD .

2.8.11 Day/Night Service

Automatic Night Service:

Your system will change the Day/Night mode at the pre-programmed time each day.

Manual Night Service:

You can change the Day/Night mode at any time.

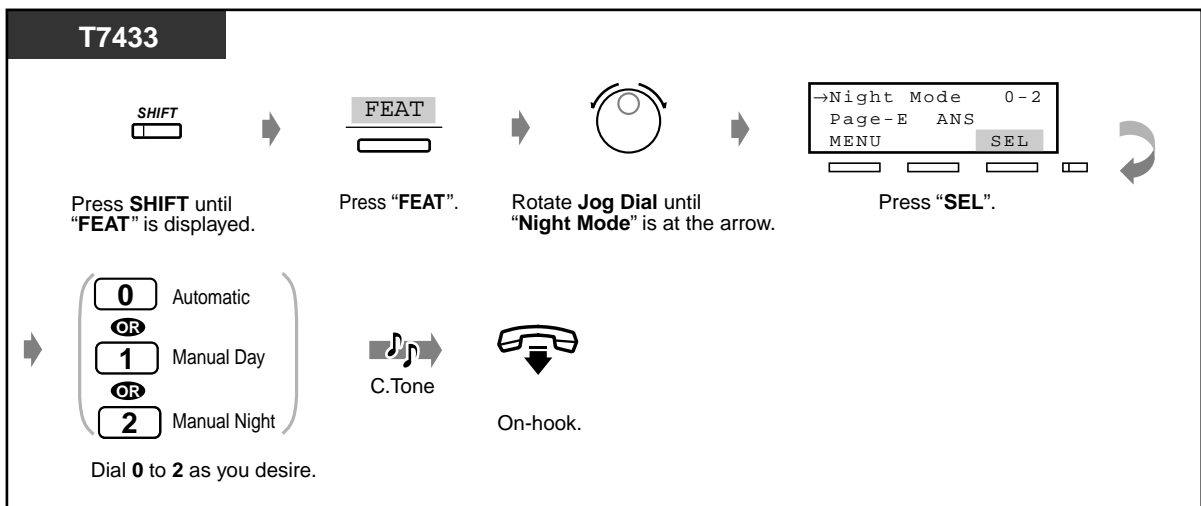
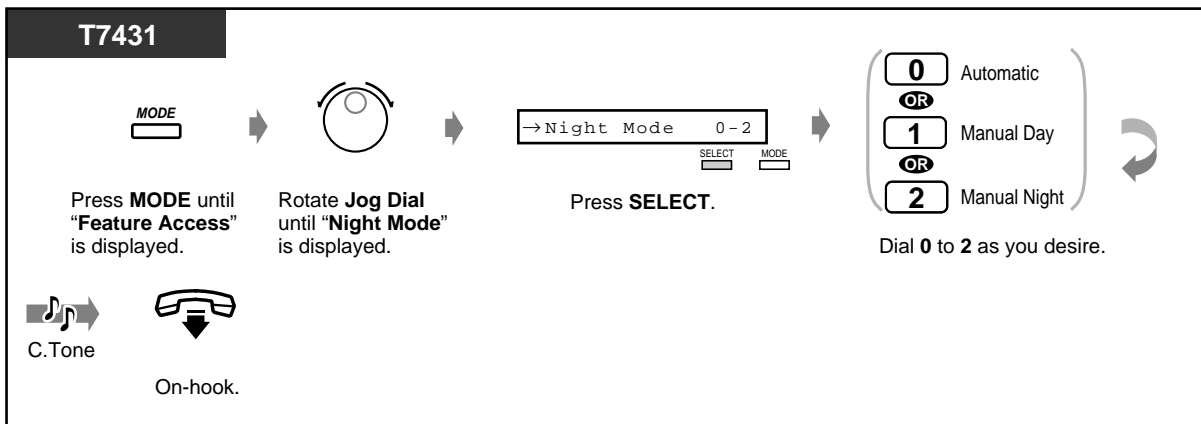
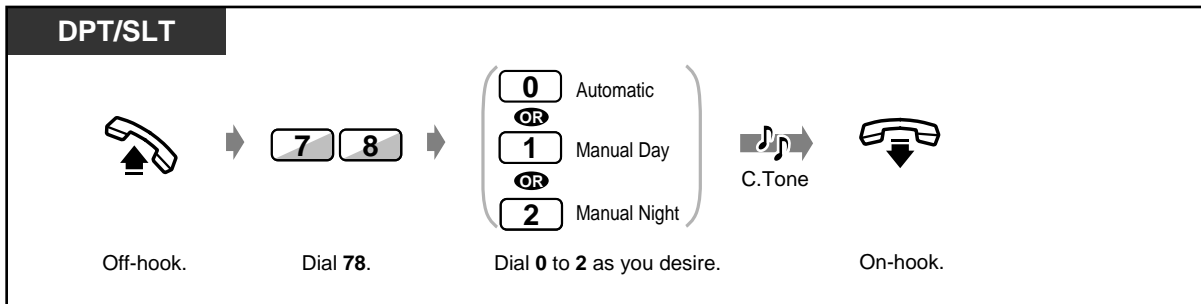

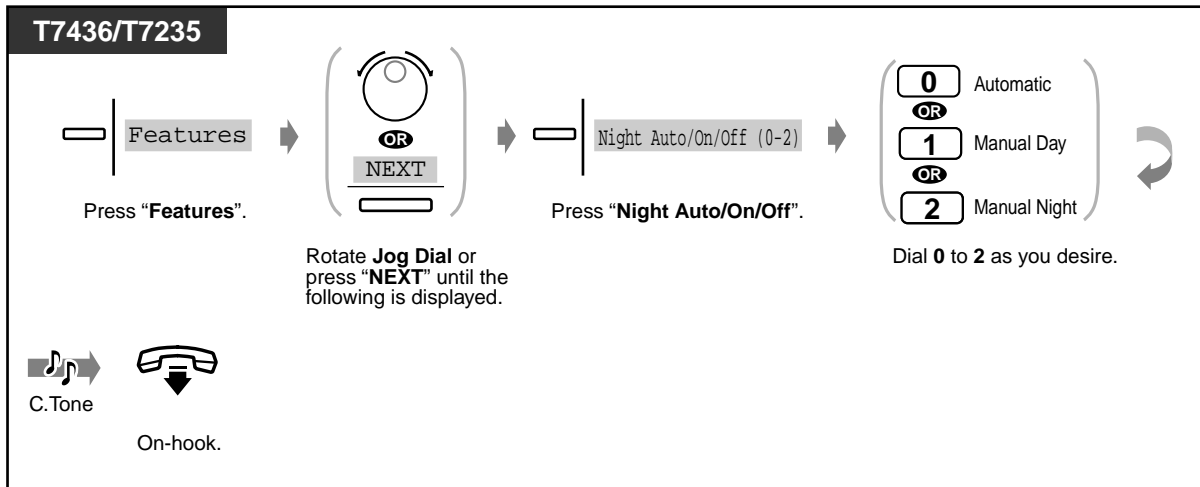

- The Night button alternates the setting between Day and Night modes. If pressed, it also changes automatic mode to manual mode, but not vice versa.
- **To confirm the current mode**, press the # key while on-hook.
- The Night button light shows the current status as follows:
Off: Day mode
Red: Night mode
- Pre-assigned extension user can also change the mode.
- This feature can be disabled by Class of Service programming. (However, the feature cannot be disabled for the operator.)



Customising Your Phone

- 4.1.3 Customising the Buttons
 Create or re-arrange a Night button.

2.8.12 Checking the Day/Night Service Status

You can see if the system is in the Day Mode (business hours) or the Night Mode (after business hours).

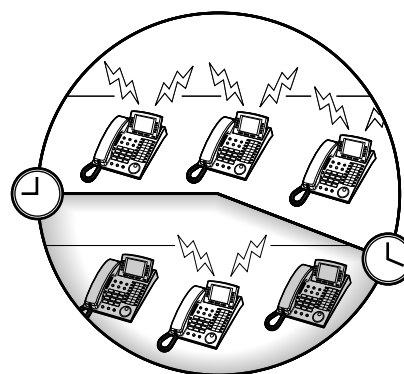
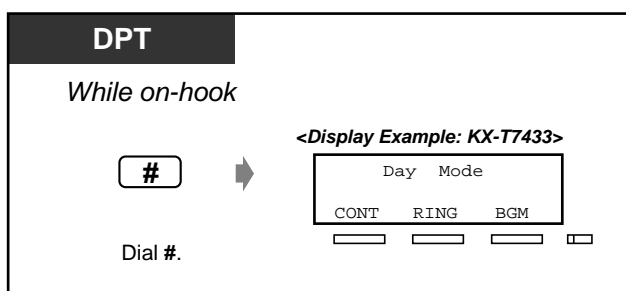

- Any extension user can check the status.
- The Night button light shows the current status as follows:

Off: Day mode

Red: Night mode



Customising Your Phone

- 4.1.3 Customising the Buttons
Create or re-arrange a Night button.

2.8.13 Setting the Parallel Connected Telephone Ringer (Paralleled Telephone)

A digital proprietary telephone user can choose whether the single line telephone connected in parallel will ring or not, when an incoming call is received.

(Default: No ring)

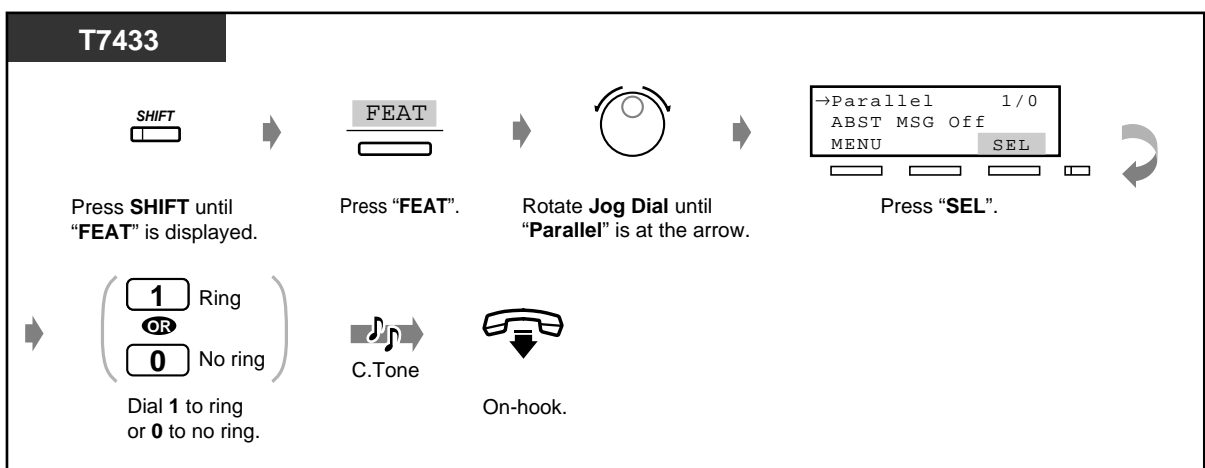
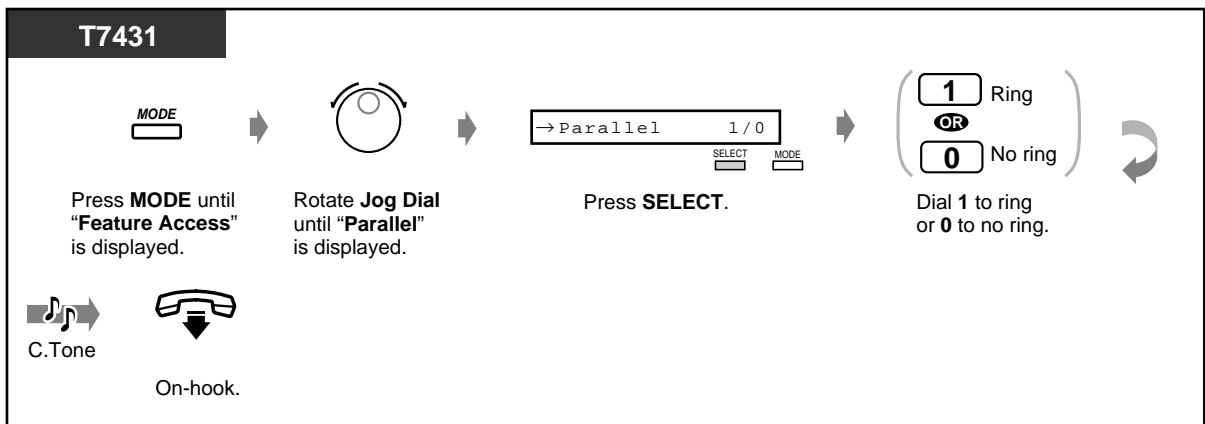
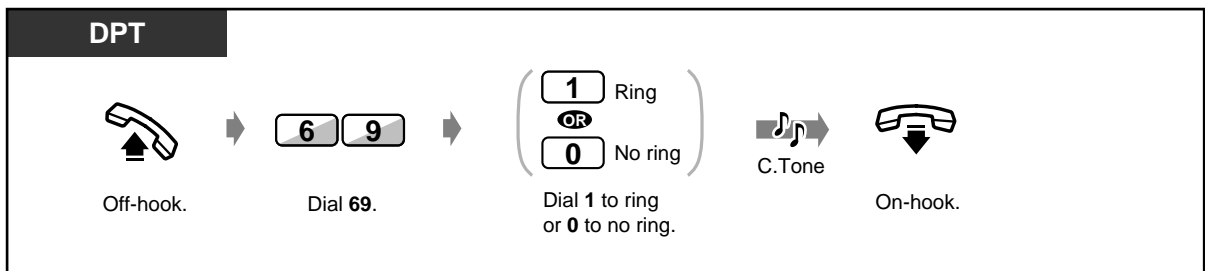

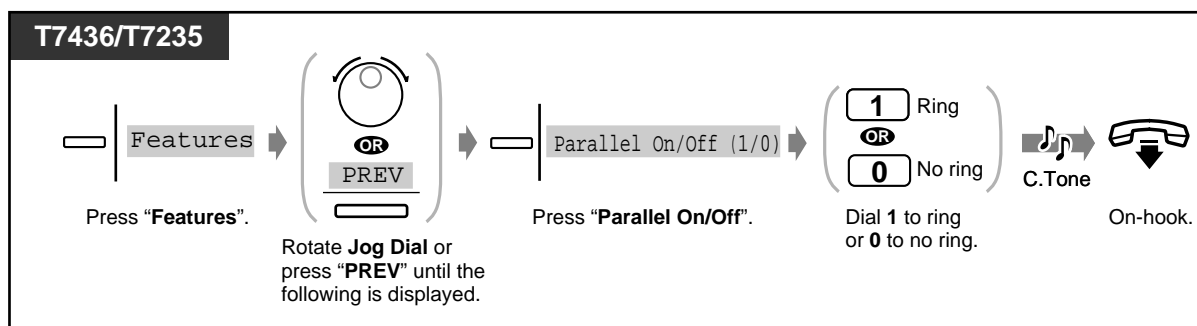

- You can select "Ring" or "No ring" by simply pressing the Paralleled Telephone Connection button. If "Ring" is selected, the button light turns red.
- **Even if "No ring" is selected**, the call can be answered with the single line telephone by lifting the handset.
- If you go off-hook while your paralleled telephone is in use, the call will switch over to your telephone, and vice versa.
- If "Ring" is set, the single line telephone will ring when the Timed Reminder reaches the set time.



Customising Your Phone

- 4.1.3 Customising the Buttons
Create or re-arrange a Paralleled Telephone Connection button.

2.8.14 Clearing the Feature Settings at Your Extension (Station Programme Clear)

You can clear the following features which have been set on your phone. If you change desks, and notice settings which a previous owner left on the line, you can clear these features.

- Calling to a Pre-set Party by Going Off-Hook (Pickup Dialling): The stored number will be cleared.
- Reserving a Busy Line (Automatic Callback Busy)
- Leaving a Message Waiting Indication (Message Waiting): All messages will be removed.
- Forwarding Your Calls (Call Forwarding)
- Showing an Absent Message on the Caller's Telephone Display (Absent Message Capability)
- Leaving a Hunting Group (Log-In/Log-out)
- Calling Using the Call Log (Incoming Call Log)
- Setting the Alarm (Timed Reminder)
- Refusing Incoming Calls (Do Not Disturb [DND])
- Receiving a Call Waiting (Call Waiting/Off-Hook Call Announcement [OHCA]/Whisper OHCA)
- Denying the Paged Announcement (Paging — Deny)
- Denying Other People the Possibility of Picking up Your Calls (Call Pickup Deny)
- Denying Other People the Possibility of Joining Your Conversation (Executive Busy Override Deny)
- Turning on the Background Music
- Setting the Parallel Connected Telephone Ringer (Paralleled Telephone): The single line telephone will not ring.
- If a Second Ringer is set to Ring: The setting will be cancelled.
- Preventing Your Number Being Displayed on the Called Party's Telephone (CLIR)
- Preventing Your Number Being Displayed on the Calling Party's Telephone (COLR)

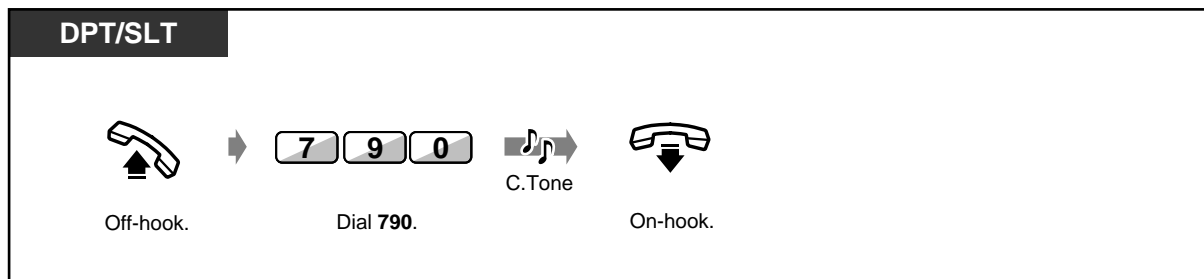

2.8.15 Identifying Malicious Callers (Malicious Call Identification [MCID])

You can ask your telephone company to trace a malicious caller during a conversation or after the opposite party hangs up.

You will receive information on the malicious call later on.

◆ To request MCID

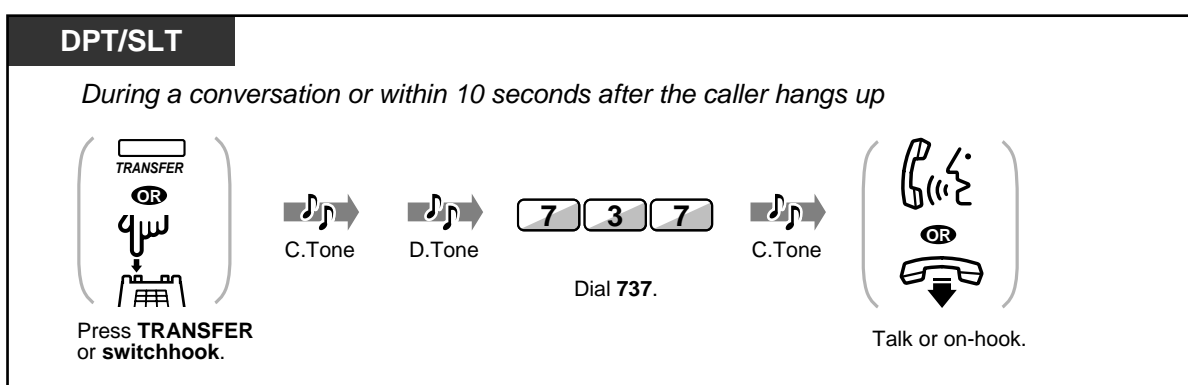

- A special arrangement with the ISDN carrier is required to utilise the MCID service. Consult your dealer for further information.
- The system is designed and manufactured in accordance with the following ETS (European Telecommunication Standard) specifications:
ETS 300 130 Malicious Call Identification (MCID) supplementary service
- The MCID service is only available for calls using an ISDN line. Not available during a three-party conference call.
- After dialling 737, if you hear a reorder tone or do not hear any tone, your request is not accepted. **To request MCID again**, press the TRANSFER button (DPT) ; or press the switchhook lightly (SLT) and then dial 737 again. If the caller hangs up, you must try again within 10 seconds.
- This service is also available for the ISDN extension users.
Please refer to the instruction manual of your ISDN extension for further information about operation.

2.8.16 Setting the Maximum Number of Busy Extension for a Hunting Group (Busy on Busy)

If the number of busy extension in a hunting group is equal to or greater than the assigned number, it is possible to send the busy tone to a new caller. This is effective to prevent the caller from thinking that there is no one in your office or your office is closed.

Hunting Group

A hunting group is a group of extensions organised in such a way that if the first destination is busy, the next destination is hunted until an idle destination is found. The order (hunting type) is assigned in a system programming. Consult your manager.

<Example>

When the maximum number of busy extension is set to 1.

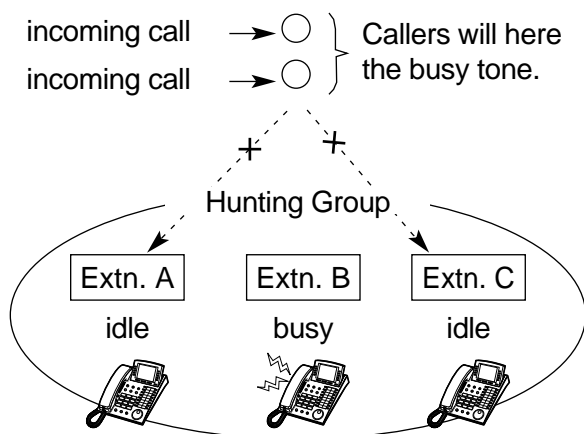

◆ To set busy on busy

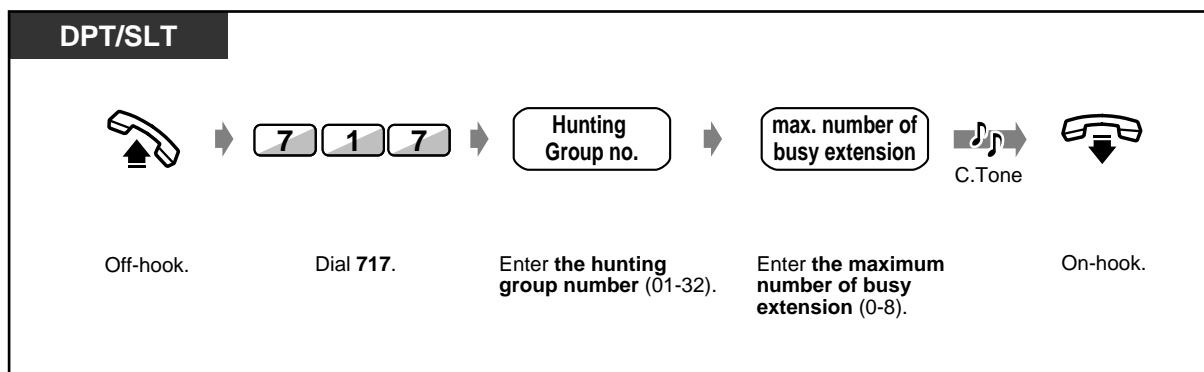

- If you set **0** as the maximum number of busy extension, this function will be disabled. The calls will reach to an idle extension in the hunting group.
- This operation is only available for the extension which belongs to the corresponding hunting group.
- If the queue length is set to more than 0, the call will be put in a waiting queue, unless the number of calls in a queue exceeds the assigned limit.

2.9 Using User-supplied Equipment

2.9.1 If a Doorphone/Door Opener is Connected

- Doorphone call
- Forwarding doorphone calls to outside parties
- Opening the door

◆◆ Doorphone call

◆ To call from the doorphone

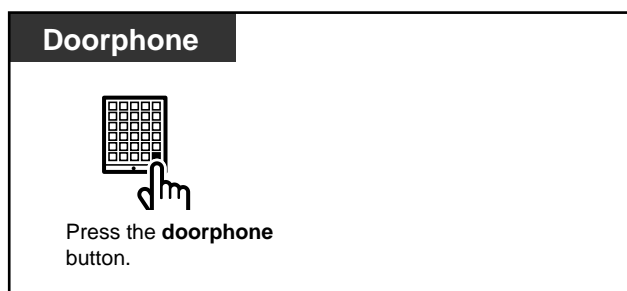

◆ To call the doorphone

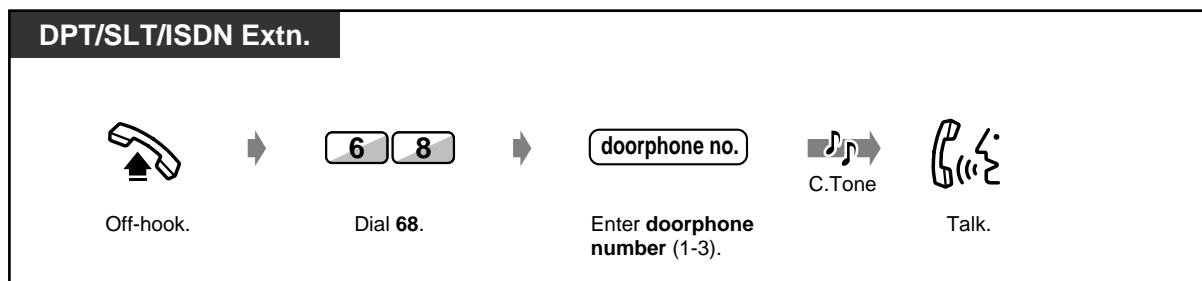

◆◆ **Forwarding Doorphone Calls to Outside Parties (Doorphone Call Forwarding to Outside Line)**

You can have incoming doorphone calls forwarded to outside parties using ISDN lines. You can choose a different destination for Day mode and Night mode. Some extensions may be restricted.

◆ **To set/cancel (at the extension receiving doorphone calls)**

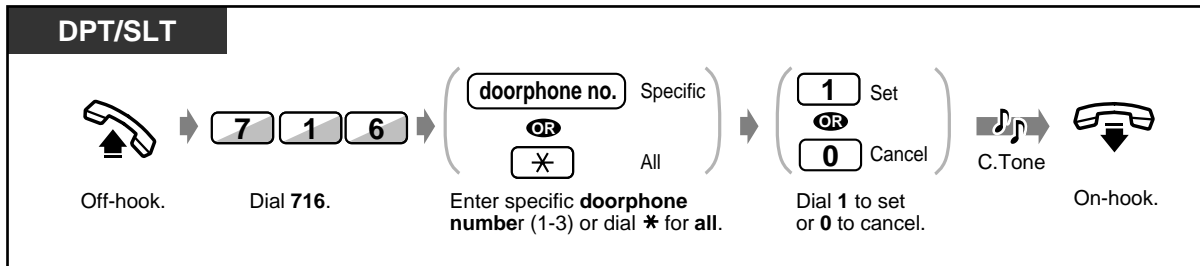

◆ **To store a phone number**

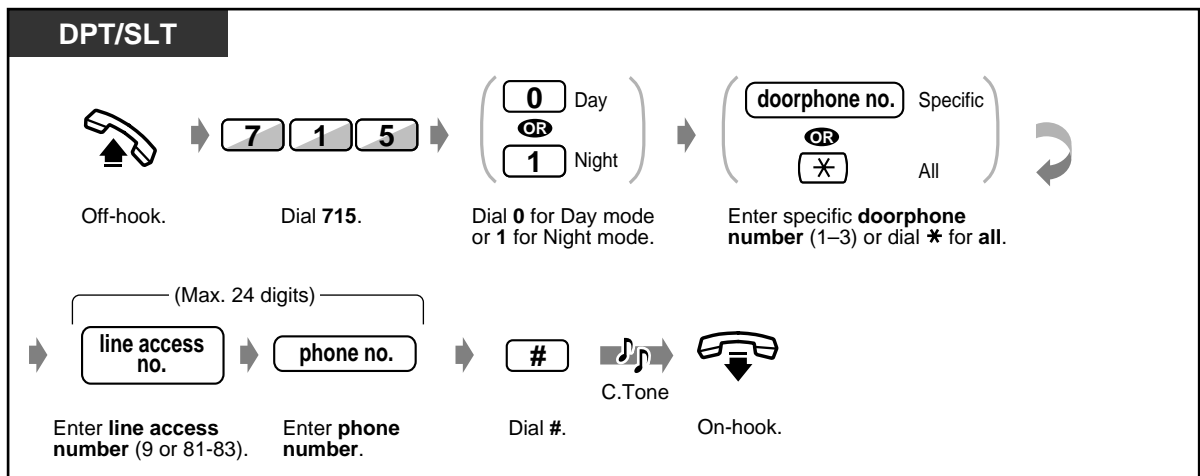

- If calling a stored outside party's number uses an analogue CO line, doorphone calls cannot be forwarded.

◆ To clear the phone number

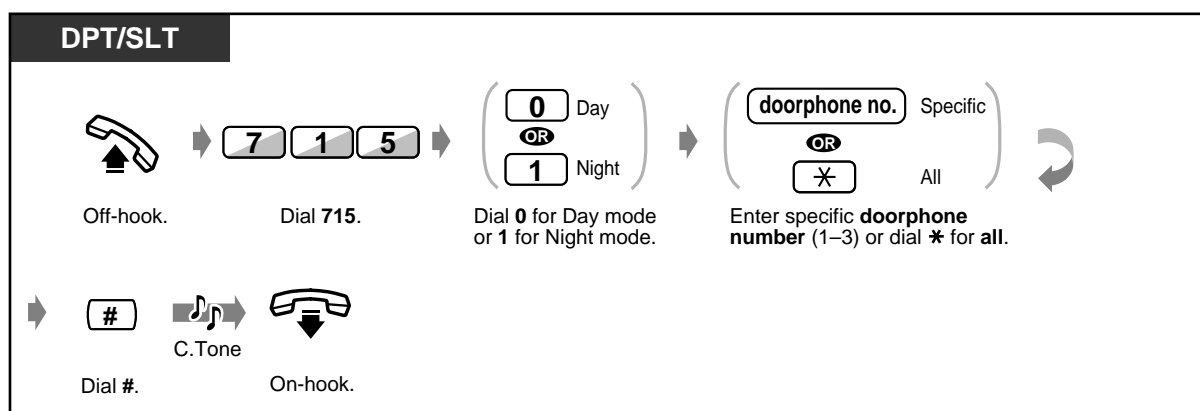

- You can set or cancel this feature by simply pressing the Doorphone Call Forwarding to Outside Line button. If set, the button light turns red.
- Time limit**
A call between a party at a doorphone and an outside party is restricted by the system timer (Default: 0 s [no limit]). The call is disconnected when the time runs out.
- If at least 1 feature has been changed from the default setting, you normally hear dial tone 2 when going off-hook. However even if you set this feature, dial tone 2 will not be heard. (Refer to 5.4.1 What is This Tone? — when going off-hook.) The Doorphone Call Forwarding to Outside Line button light shows the current status as follows:
Off: This feature has not been set.
Red on: This feature has been set.



Customising Your Phone

- 4.1.3 Customising the Buttons
Create or rearrange a Doorphone Call Forwarding to Outside Line button.

◆◆ Opening the door

Some extensions may be restricted from performing this function.

◆ From a specified extension

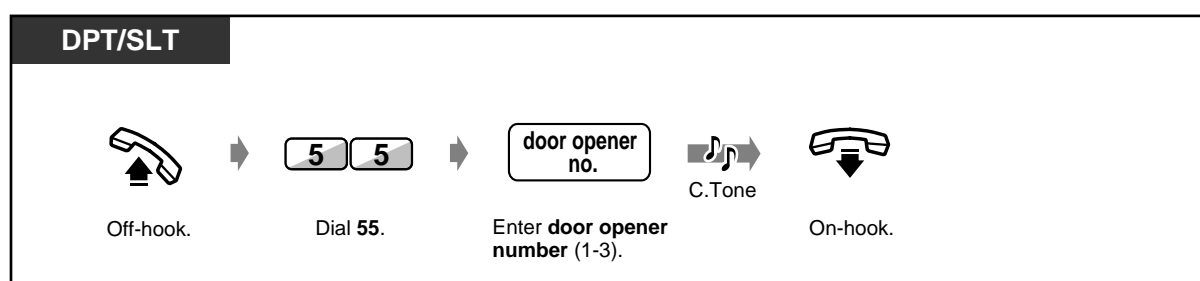

◆ *From any extension while talking to the doorphone*

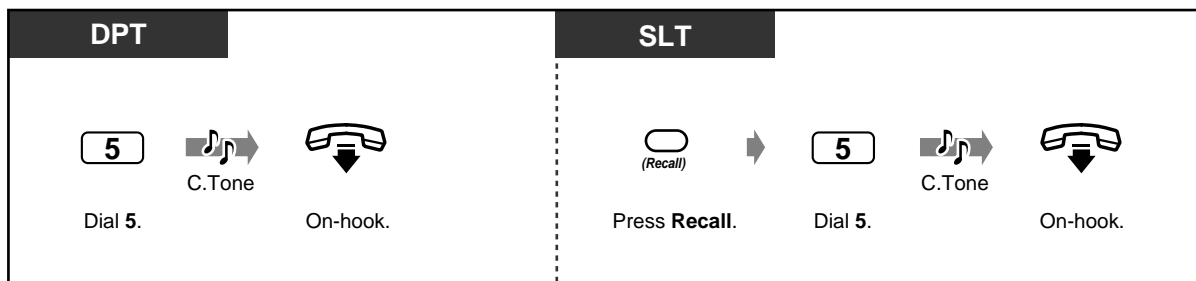

- The door opening duration can be determined by System Programming. Consult your dealer.
- **To keep the door open for another pre-assigned period of time while talking to the doorphone, dial 5 again using a Panasonic digital proprietary telephone.**
- **If no one answers the doorphone call within 30 seconds, the call is cancelled.**

2.9.2 If a Host PBX is Connected

◆◆ Accessing external services (External Feature Access)

You can access special features (e.g. Call Waiting) offered by a host PBX or Central Office. This feature is only available with an analogue CO line.

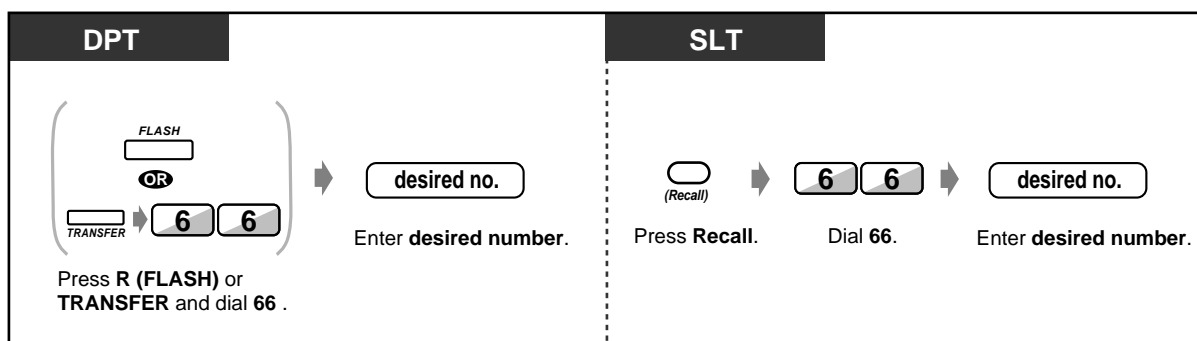
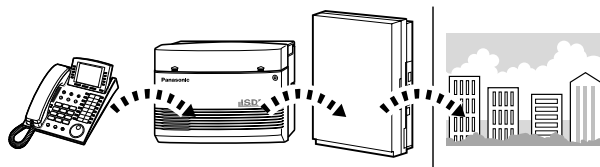

2.9.3 If a Voice Processing System is Connected

— Voice mail integration for digital proprietary telephone (DPT Integration)

If your system is connected to a Panasonic Voice Processing System which can be used with a digital proprietary telephone, the following functions are available:

- Screening calls
- Recording a conversation

Note

If you set the Voice Mail feature, the functions of the Built-in Voice Message (BV) will be disabled except for the following.

- (1) Company Greeting OGM for DISA feature
- (2) Recording, replaying, or deleting Company Greeting OGM

◆◆ DPT Integration

If you cannot answer calls, you can forward them to your mailbox. If your telephone has a MESSAGE button, the button light turns on and lets you know you have messages. Even if a MESSAGE button is not provided, you will hear an indication tone* when going off-hook.

You can also transfer received outside calls to a certain mailbox so that callers can leave messages. If you create a Voice Mail Transfer button on your phone, the transfer is done easily without confirming the voice mail extension number (Voice Mail Transfer).

◆ To forward your calls to your mailbox

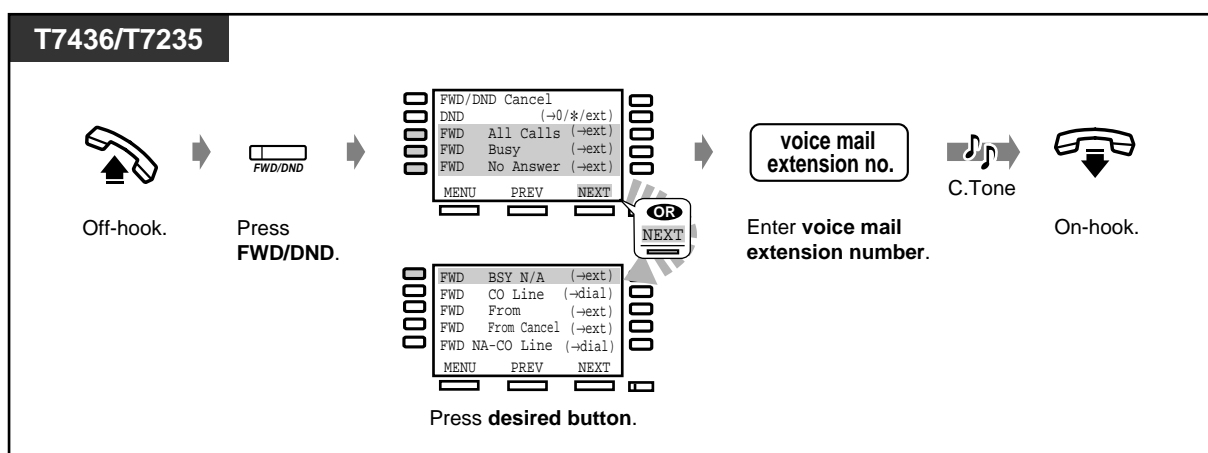
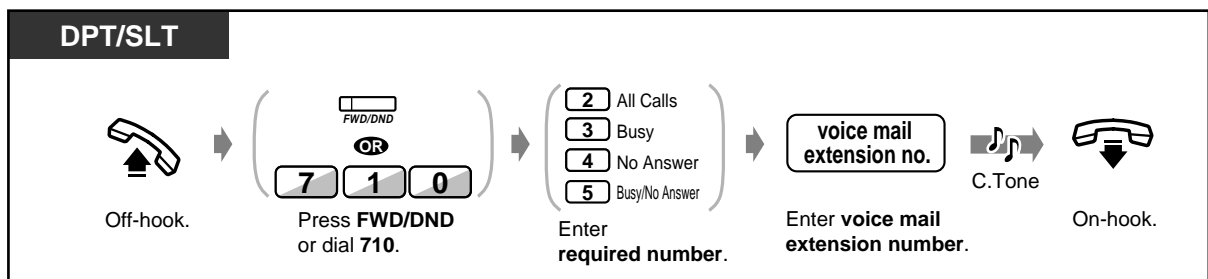

◆ **Transferring calls**

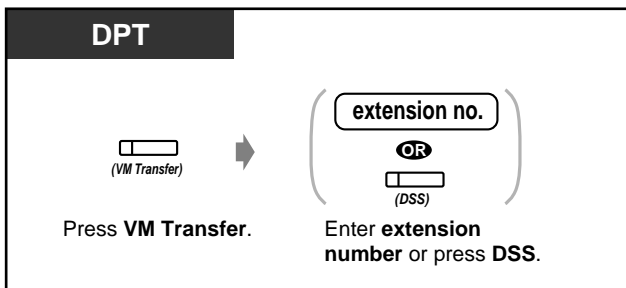

◆ **To check and select the message**

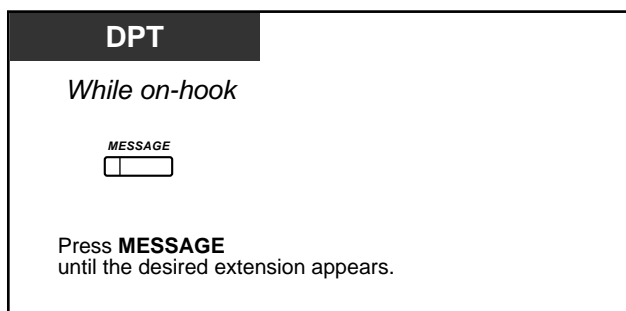

 You can also select the party who left the message waiting indication. Refer to 2.2.4 When the Dialed Line is Busy or There is No Answer — Leaving a Message waiting indication (Message Waiting)

◆ **To listen to a stored message**

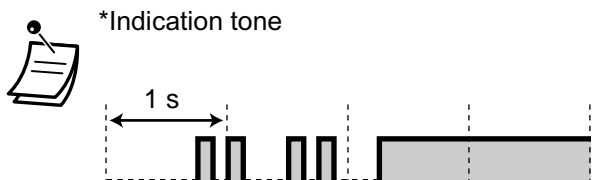
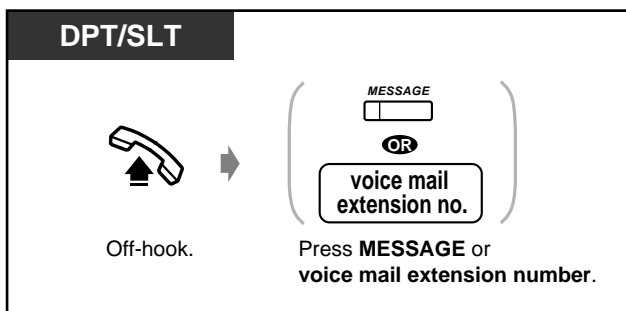

 **Customising Your Phone**

- 4.1.3 Customising the Buttons
Create or re-arrange a MESSAGE button and Voice Mail (VM) Transfer button.

◆◆ **Screening calls (Live Call Screening [LCS])**

While a caller is leaving a message in your mailbox, you can monitor the call. If desired, you can answer the call while monitoring. There are 2 methods available (Default: Hands-free mode). In both modes, if you are currently having a conversation, you will hear a call waiting tone.



Hands-free mode:

You can monitor the message automatically through the telephone speaker at the same time.

Private mode:

You will hear an alert tone while the caller is leaving a message.

Before operating

- Create a Live Call Screening (LCS) button (Station Programming).
- Select the mode, either Hands-free or Private (Station Programming).
- Set the Password.
- Set the Live Call Screening feature.

◆ **To set/cancel the password**

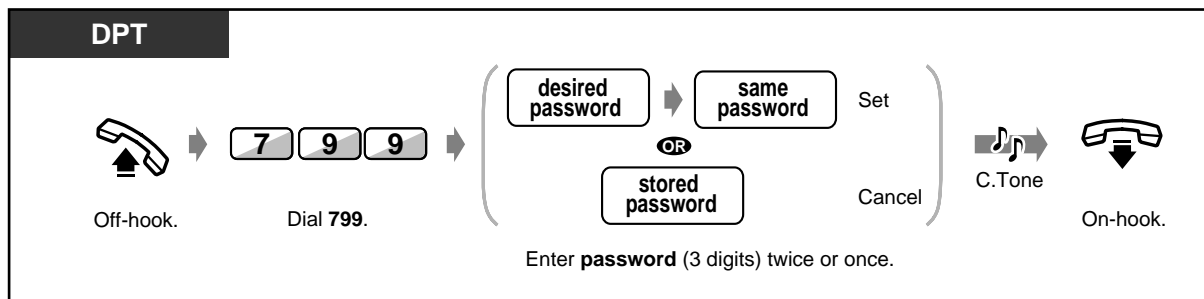

◆ **To set Live Call Screening**

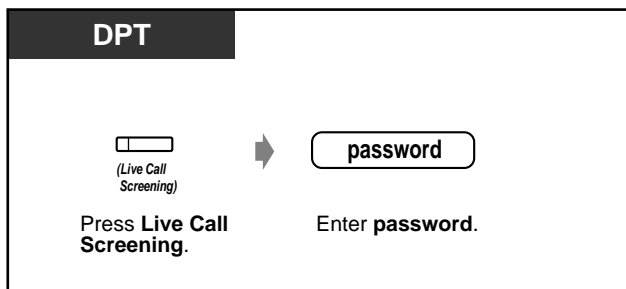

◆ To cancel Live Call Screening

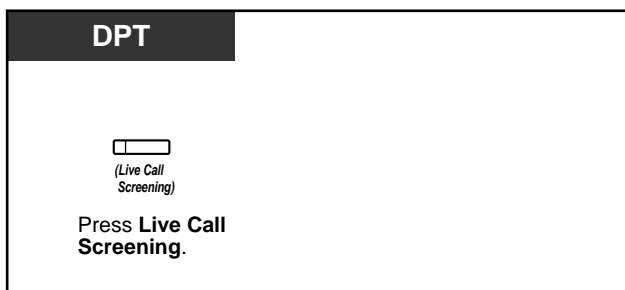

Operation Flowchart

The operations in the shaded areas can be hands-free operations.

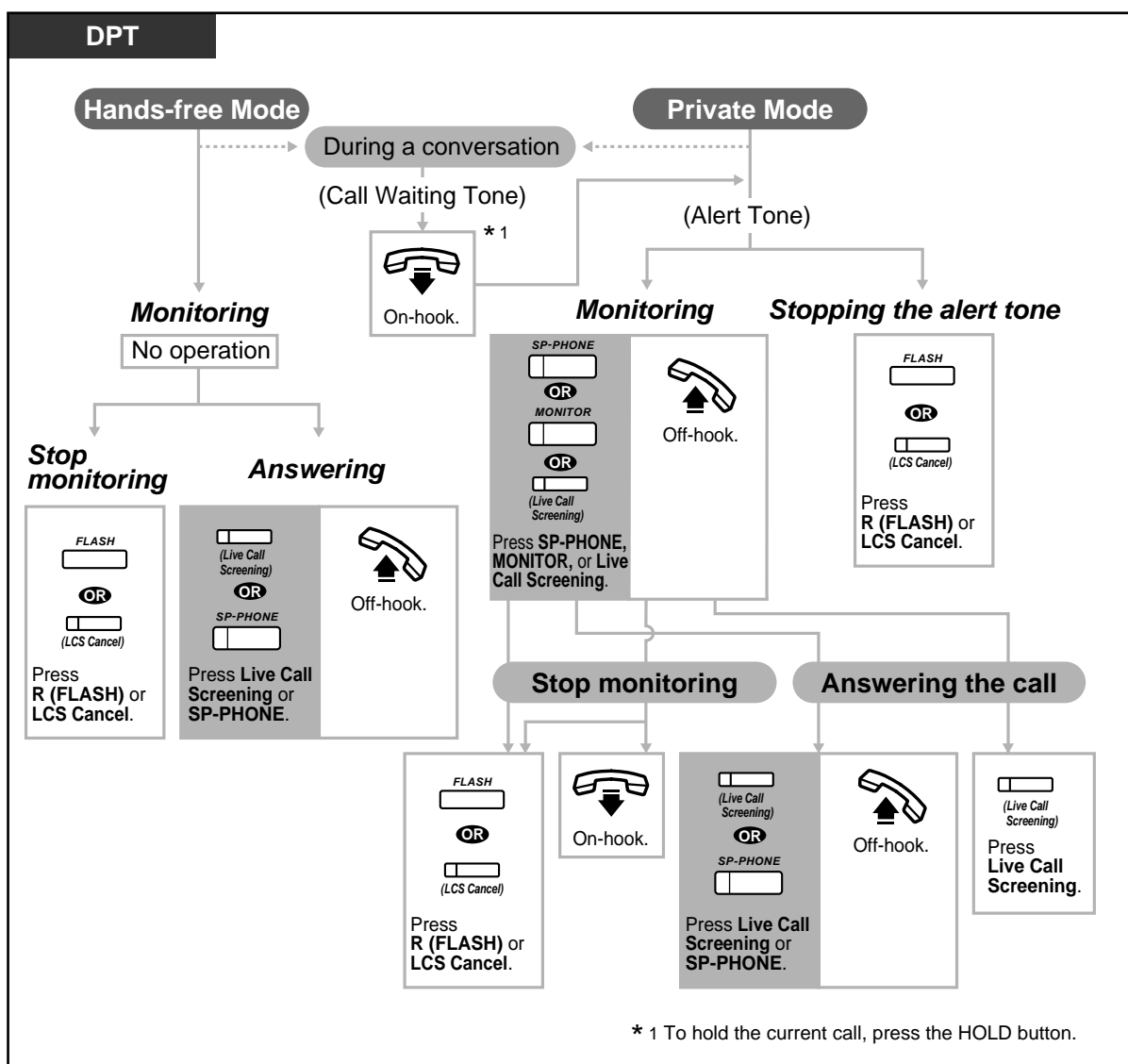



- The Live Call Screening (LCS) button light shows the feature status as follows:

Red on: LCS is on.

Off: LCS is off.

Flashing green rapidly: Alert ringing in the Private mode.*

Flashing green slowly: Live Call Screening is in use.*

* The DSS button light is red while Live Call Screening is in use.

- The operator can clear the password at any extension.



Customising Your Phone

- 4.1.2 Initial Settings — **Live Call Screening Mode Set**
Select the mode, either monitoring the message automatically or receiving alert ringing, when the caller leaves a message.
- 4.1.3 Customising the Buttons
Create or re-arrange a Live Call Screening button and Live Call Screening Cancel button.

◆◆ Recording a conversation (Two-Way Recording)

You can record a conversation into a mailbox while talking on the phone.



◆ To record into your mailbox

DPT

During a conversation

(Two-Way Record)

To stop recording, press this button again.

Press **Two-Way Record**.

◆ To record into another mailbox

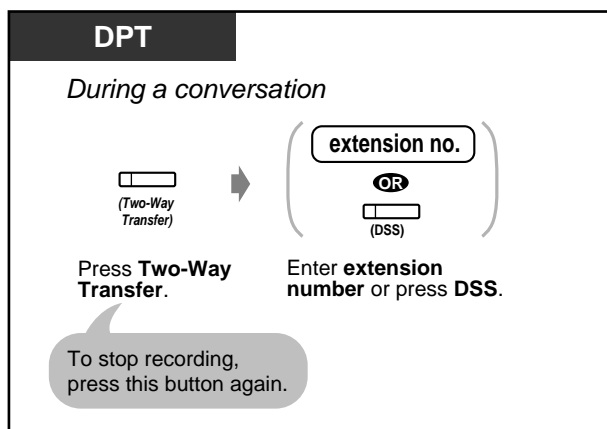

- The Two-Way Record button light shows the current status as follows:

On: Recording the conversation.

Off: Not recording.



- When you record Two-Way telephone conversations, you should inform the other party that the conversation is being recorded.



Customising Your Phone

- 4.1.3 Customising the Buttons
Create or re-arrange a Two-Way Record button and Two-Way Transfer button.

Note

Below are additional DPT Integration features which may be of interest to you if you have the Panasonic TVP50 Voice Processing System. For additional information, please see the documentation of the TVP50 or ask your dealer.

Feature	Description
Direct Mailbox Access	The subscriber is entered directly into his mailbox when he calls the VPS. He does not have to dial his mailbox number.
Intercom Paging	Callers can page subscribers through built-in speakers and paging equipment. For a CLIP caller, if his name has been recorded for the Caller Name Announcement feature, the name will be announced at the end of the page.
Caller Name Announcement (System/Personal)	A pre-recorded announcement of the CLIP caller's name is heard when extension users listen to messages left in their mailboxes or calls are transferred from the VPS to the users.

Feature	Description
Caller ID Call Routing	The VPS automatically sends calls from pre-assigned CLIP numbers to the desired extension, mailbox, or Custom Service. Custom Service is especially useful in a country where several languages are used, because Custom Service menus can be recorded in any language.
Personal Greeting for Caller ID	Each subscriber can record up to 4 personal greeting messages for special callers.

2.9.4 If an External Relay is Connected

Pre-assigned extension users can switch on a relay connected to the system.

◆ To switch on

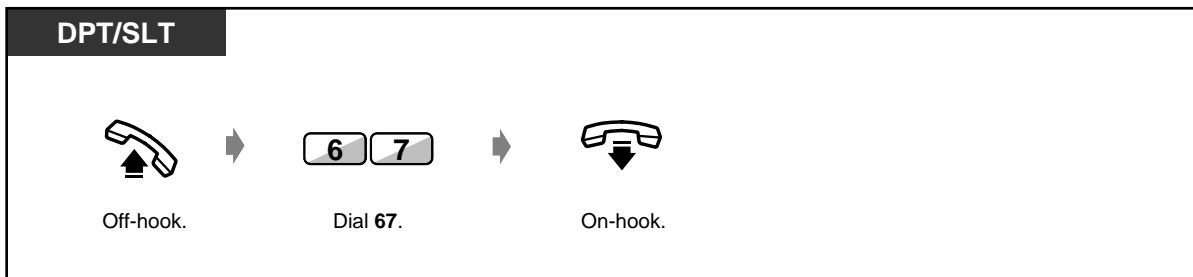

- You can select by system programming the time the relay is activated. If you assign 0, the relay is on while you are off-hook. Consult your dealer.

2.9.5 If a Second Ringer is Connected

You can set (as described below) the second ringer to ring when an intercom or outside call comes in. Both your extension and the second ringer will ring; and both will not ring if you set Do Not Disturb (DND). You can answer the ringer from any extension.

◆ **To set**

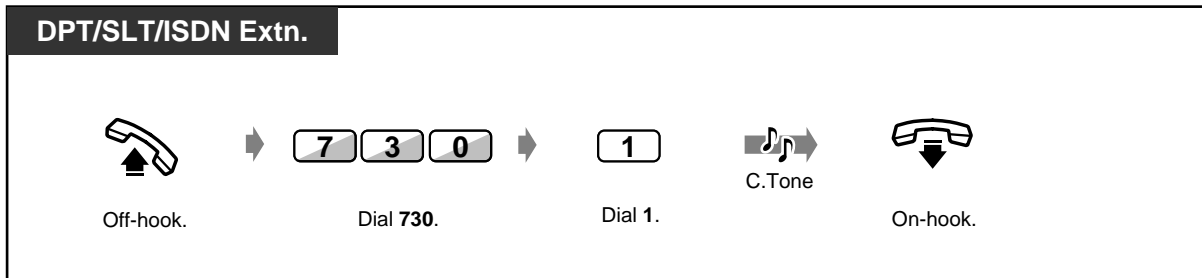

◆ **To cancel**

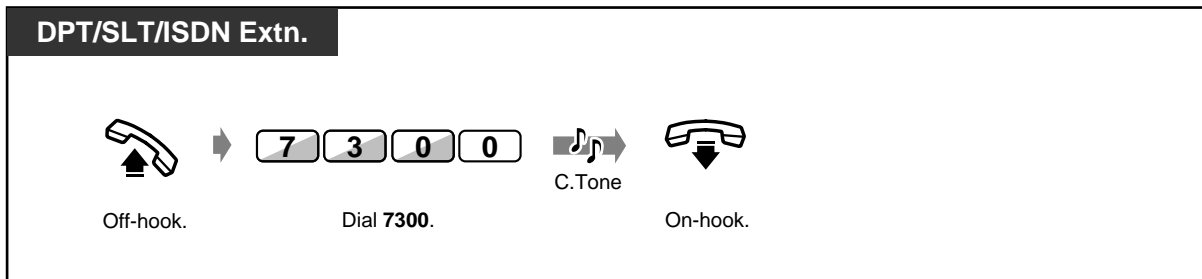

◆ **To answer (available only when the second ringer is ringing)**

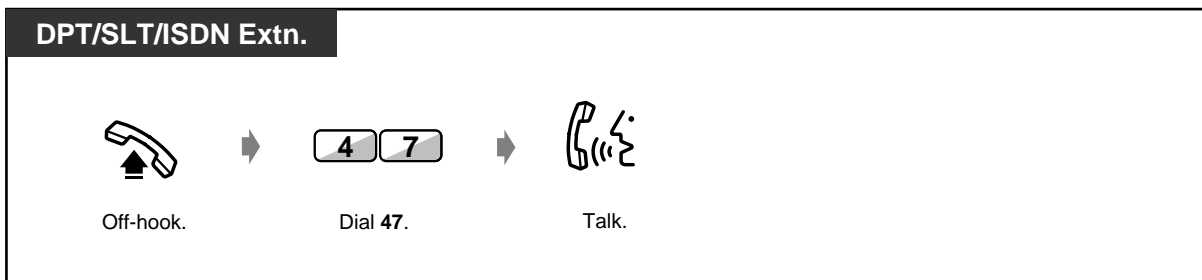

- System programming overrides the setting described above; if the Second Ringer is enabled, you cannot cancel it at a telephone. Ask your manager.
- It is possible to set to ring a Second Ringer only when a call from doorphone comes in. System Programming is required. Consult your dealer.

2.10 Using the Display Proprietary Telephone

2.10.1 Calling Using the Call Log (Incoming Call Log) [KX-T7433, KX-T7436, KX-T7230, KX-T7235 only]

If you do not answer an outside call, the caller's information is recorded automatically in the call log. When a new call information is stored, the SHIFT button turns red. However, if the call is received at several extensions (1:N reception), then only the button of the lowest extension will light. You can also store call information during a conversation. (See "2.10.2 Recording a Call Log [KX-T7433, KX-T7436, KX-T7230, KX-T7235 only]").) Up to 128 differently identified calls can be logged per extension. This is owned jointly with the call log of the built-in voice message. (However, in the event a voice message is recorded, the MESSAGE button will also turn red.) As for the call log of the Built-in Voice Message, the call information will be logged per calling even when there are several calls from the same telephone number. The 129th call overwrites the oldest call regardless of the ordinary call log or that of the Built-in Voice Message.

You can modify and call back using the logged numbers.

Note

The call log entry can be left only with an ISDN line.

CAUTION

When the call information of the Built-in Voice Message is overwritten, the voice message itself is deleted at the same time. (Refer to 2.6.1 Built-in Voice Message)

◆ To confirm

DPT

While on-hook

OLD

OR

NEW

Press "OLD" or "NEW".

<Information sample>

CO02:Panasonic01	-----	Outside line no. & either the outside line name or the name of the DDI/MSN no.
01234567890123	-----	Phone no.
Nina Thomas	-----	Caller's name
21 Aug 00 6:20	-----	Receipt date & time
Page001 10Calls	-----	Logged Page no. (max. 128) & calling time
MENU CLR NEXT		

OLD:Information you have already confirmed.
NEW:Information you have not yet confirmed.



- With the KX-T7433 and the KX-T7230, press the "INFO" key to scroll through information.

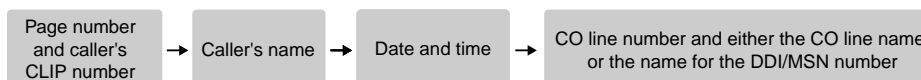

- To modify the phone no., press the "*" key to erase and then enter the number. The numbers are erased from the left. The new number is entered into memory after modification.
- To return to the initial display, press "MENU" or go off-hook and on-hook.

◆ **To lock the log**

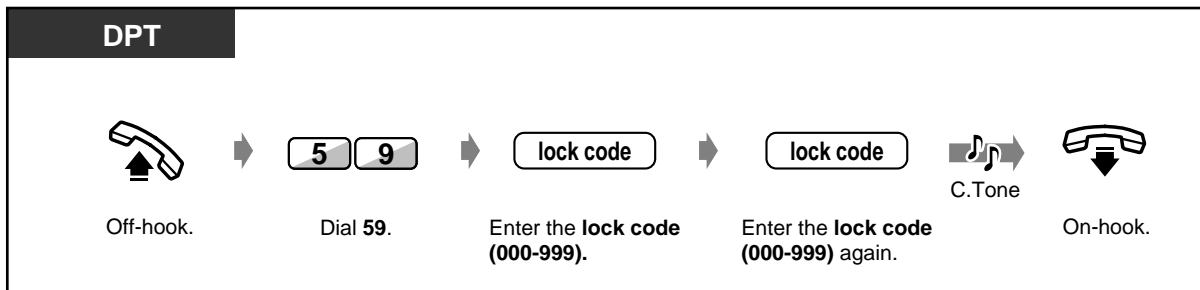

◆ **To unlock the log**

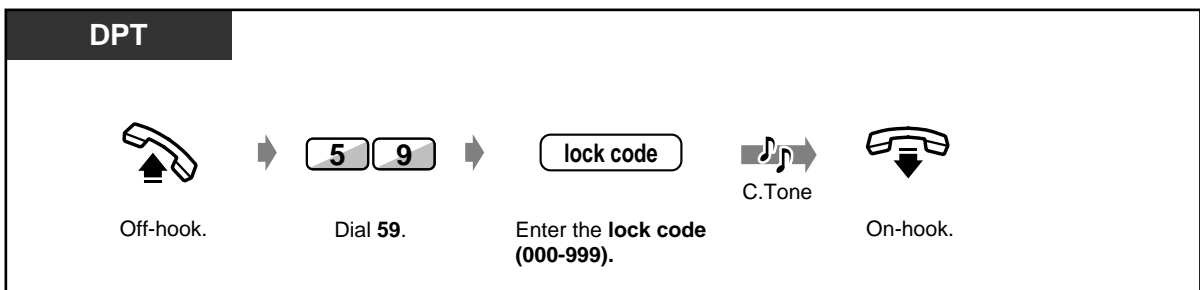

◆ **To clear one log entry**

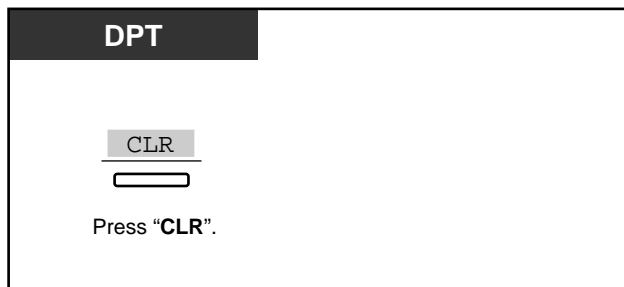

◆ **To call back**

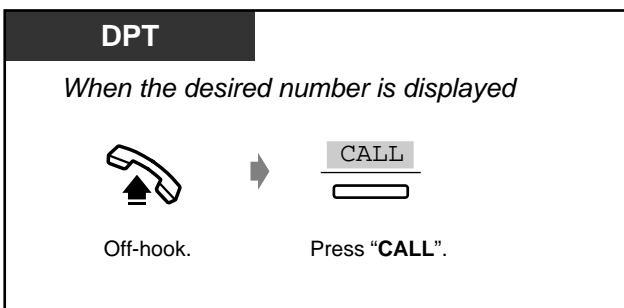



- ARS can be applied to a call using call log. Consult your dealer.

2.10.2 Recording a Call Log [KX-T7433, KX-T7436, KX-T7230, KX-T7235 only]

You can record the caller's information in the call log to call them back. If you do not answer the call, the log is recorded automatically.

Note

The call log entry can be left with an ISDN line.

◆ To record a call log



- You can also set your system to record a call log automatically when answering a call. System Programming is required. Consult your dealer.
- A digital proprietary telephone users may change the displayed message as follows by pressing the CO button. However, if you assign a wild card number at 4.2.3 System Speed Dialling and Intelligent Call Handling Number Set (001), the name assigned at 4.2.4 System Speed Dialling and Intelligent Call Handling Name Set (002) will not be displayed.

<KX-T7230>



<KX-T7433/KX-T7436/KX-T7235>

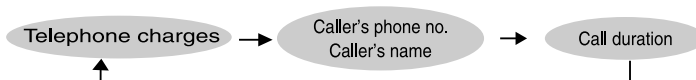

2.10.3 Using the KX-T7431, KX-T7433, KX-T7436 or KX-T7235

- Using the KX-T7431
- Using the KX-T7433
- Using the KX-T7436
- Using the KX-T7235
- Storing the names and numbers for station speed dialling
- Display feature list

◆◆ Using the KX-T7431

A KX-T7431 Panasonic digital proprietary telephone with a 1-line display allows you to make calls and operate the features using the display message. You do not have to memorise the phone numbers or feature numbers.

Operation

1. Press the MODE button repeatedly to show the desired display.
2. Rotate the Jog Dial until the desired message is shown.
(Refer to "Display feature list" in 2.10.3 Using the KX-T7431, KX-T7433, KX-T7436 or KX-T7235 for the feature messages.)
3. Press the SELECT button to call the displayed party or to select the desired feature.
4. Enter parameters if required.

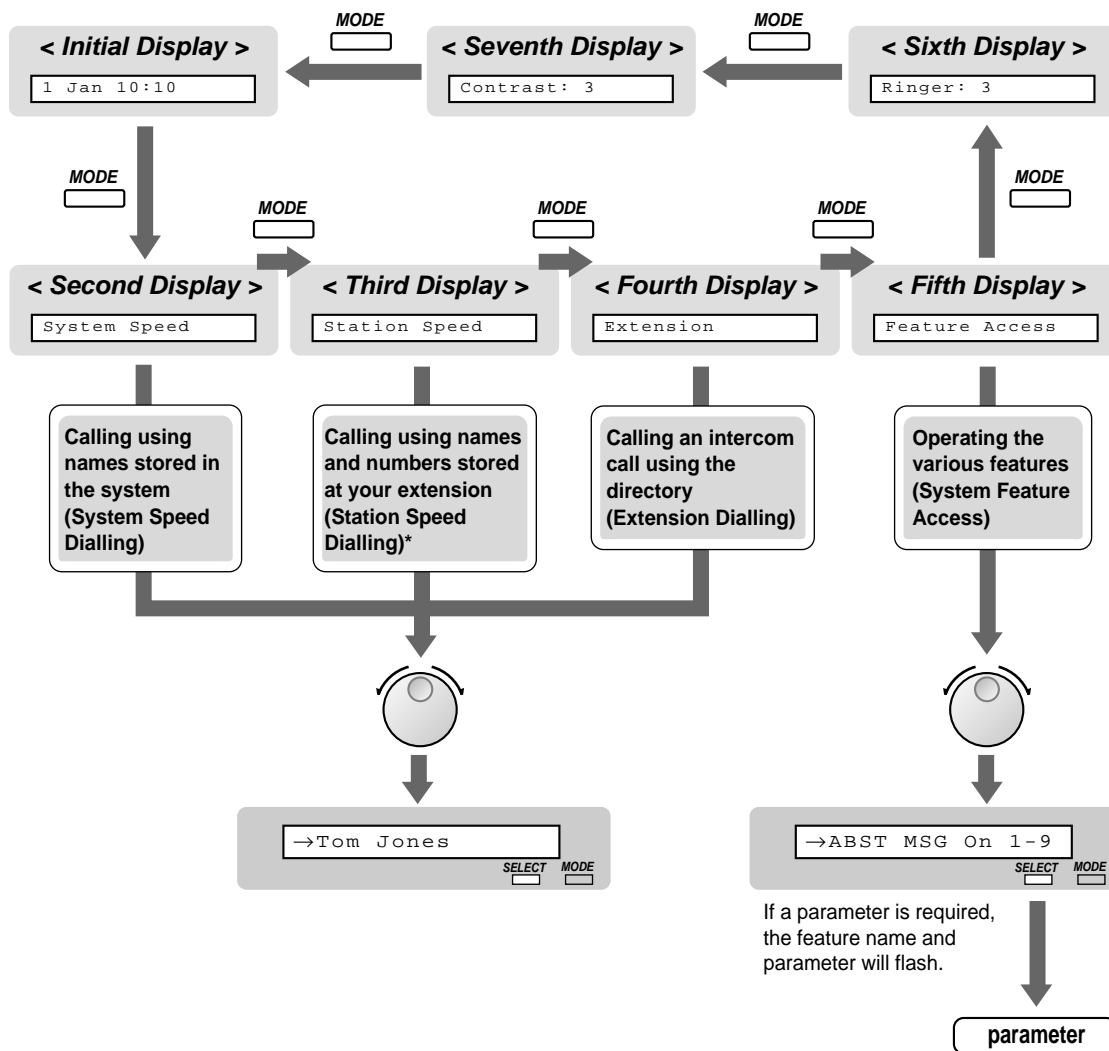

 * The names and phone numbers should be stored beforehand. Refer to "Storing the names and numbers for station speed dialling" in 2.10.3 Using the KX-T7431, KX-T7433, KX-T7436 or KX-T7235.

◆◆ Using the KX-T7433

A KX-T7433 Panasonic digital proprietary telephone with a 3-line display allows you to make calls and operate the features using the display message. You do not have to memorise the phone numbers or feature numbers.

Operation

1. Press the SHIFT button repeatedly to show the third display.
2. Press the desired button, if required.
3. Rotate the Jog Dial until the desired message is at the arrow.
(Refer to "Display feature list" in 2.10.3 Using the KX-T7431, KX-T7433, KX-T7436 or KX-T7235 for the feature messages.)
4. Press the CALL button to call the party or the SEL button to select the desired feature.

5. Enter parameters if required.

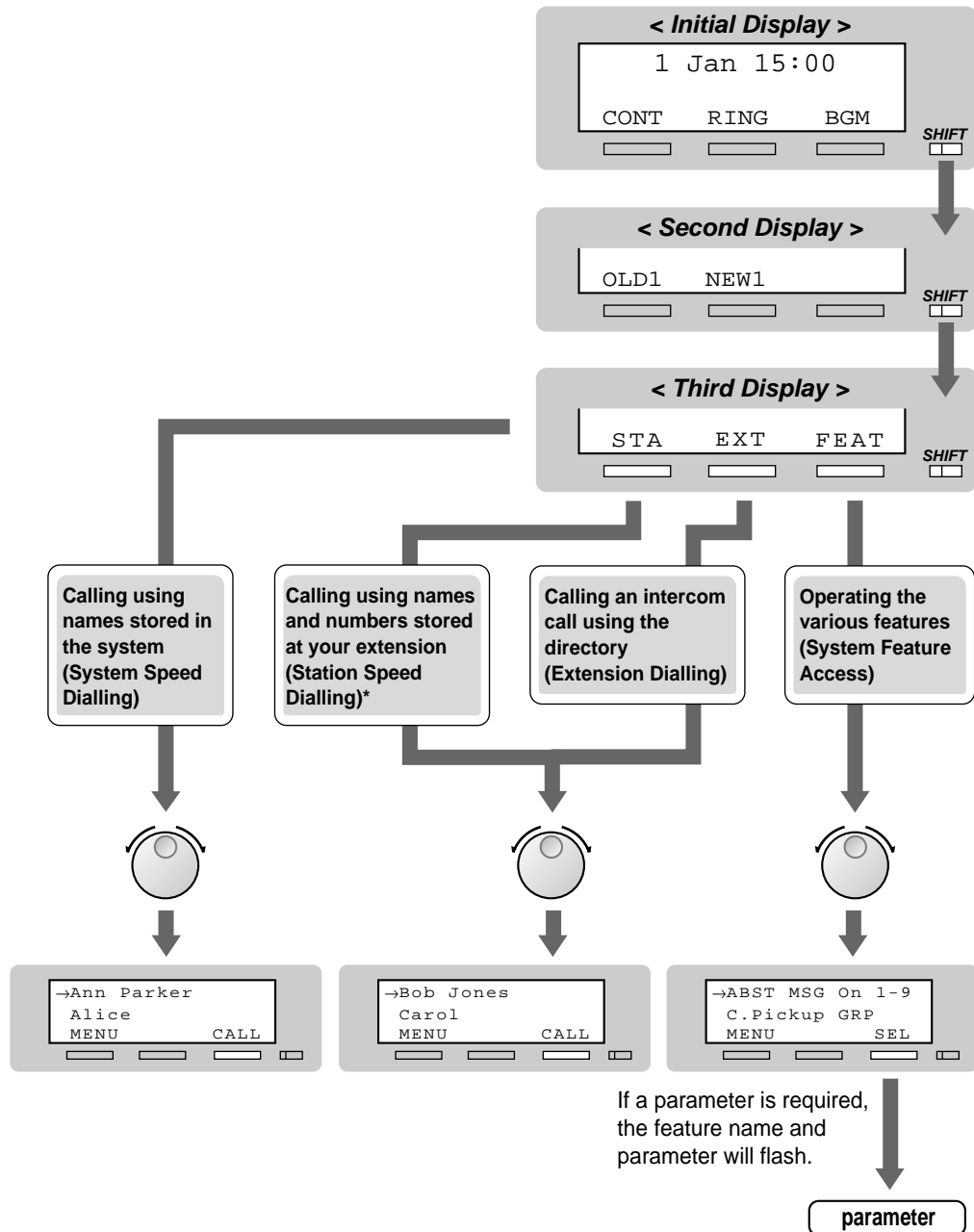

* The names and phone numbers should be stored beforehand. Refer to "Storing the names and numbers for station speed dialling" in 2.10.3 Using the KX-T7431, KX-T7433, KX-T7436 or KX-T7235.

◆◆ **Using the KX-T7436**

A KX-T7436 Panasonic digital proprietary telephone with a 6-line display allows you to make calls and operate the features using the display message. You do not have to memorise the phone numbers or feature numbers.

Operation using the function buttons

1. Press the desired function button on the initial display.
2. Rotate the Jog Dial until the desired message is at the arrow.
(Refer to "Display feature list" in 2.10.3 Using the KX-T7431, KX-T7433, KX-T7436 or KX-T7235 for the feature messages.)
3. Press the CALL button or the function button to call the party. Or press the SEL button to select the desired feature at the arrow or press the function button next to the desired feature.
4. Enter parameters if required.

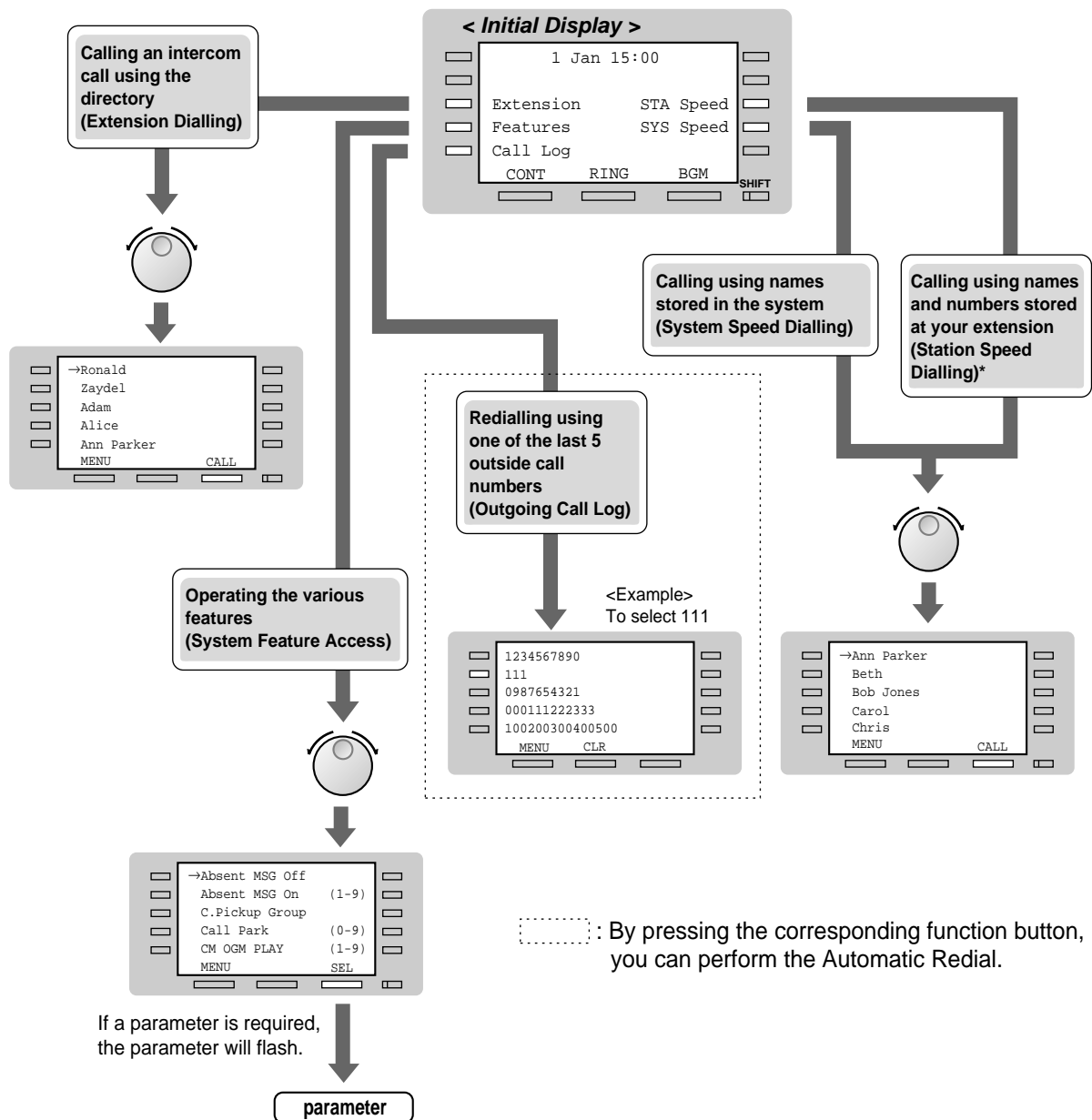



* The names and phone numbers should be stored beforehand. Refer to "Storing the names and numbers for station speed dialling" in 2.10.3 Using the KX-T7431, KX-T7433, KX-T7436 or KX-T7235.

Operation using the soft buttons

- 1.** Press the SHIFT button repeatedly to show the third display.
- 2.** Press the desired button, if required.
- 3.** Rotate the Jog Dial until the desired message is at the arrow.
(Refer to "Display feature list" in 2.10.3 Using the KX-T7431, KX-T7433, KX-T7436 or KX-T7235 for the feature messages.)
- 4.** Press the CALL button to call the party or the SEL button to select the desired feature.
- 5.** Enter parameters if required.

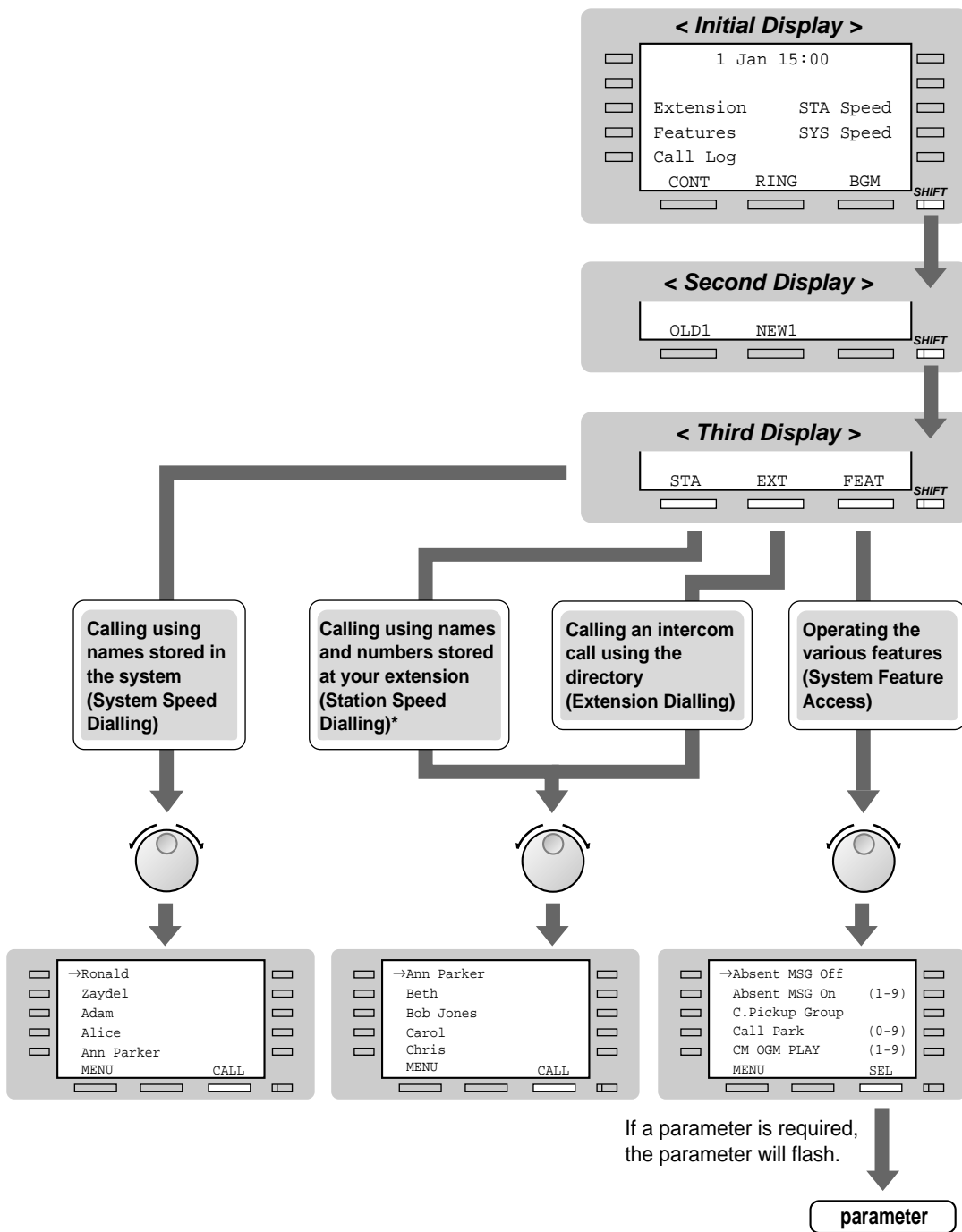

* The names and phone numbers should be stored beforehand. See refer to "Storing the names and numbers for station speed dialling" in 2.10.3 Using the KX-T7431, KX-T7433, KX-T7436 or KX-T7235.

◆◆ Using the KX-T7235

A KX-T7235 Panasonic digital proprietary telephone with a 6-line display allows you to make calls and operate the features using the display message. You do not have to memorise the phone numbers or feature numbers.

Operation

1. Press the desired function button on the initial display.
2. Press the desired function button or NEXT button until the desired message is displayed.
(See refer to "Display feature list" in 2.10.3 Using the KX-T7431, KX-T7433, KX-T7436 or KX-T7235 for the feature messages.)
3. Press the function button next to the desired party or the feature.
4. Enter parameters if required.

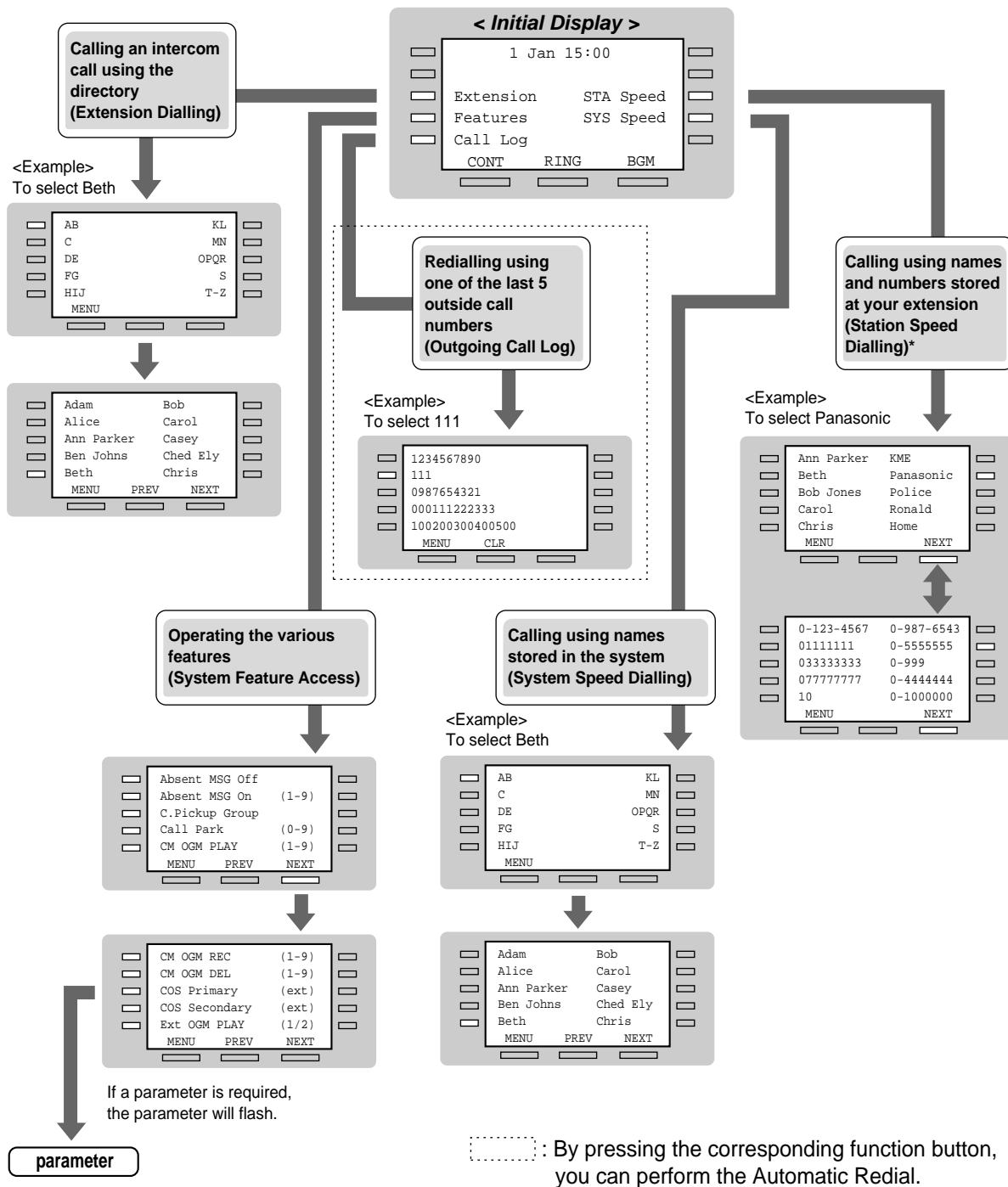

* The names and phone numbers should be stored beforehand. See refer to "Storing the names and numbers for station speed dialling" in 2.10.3 Using the KX-T7431, KX-T7433, KX-T7436 or KX-T7235.

◆◆ **Storing the names and numbers for station speed dialling**

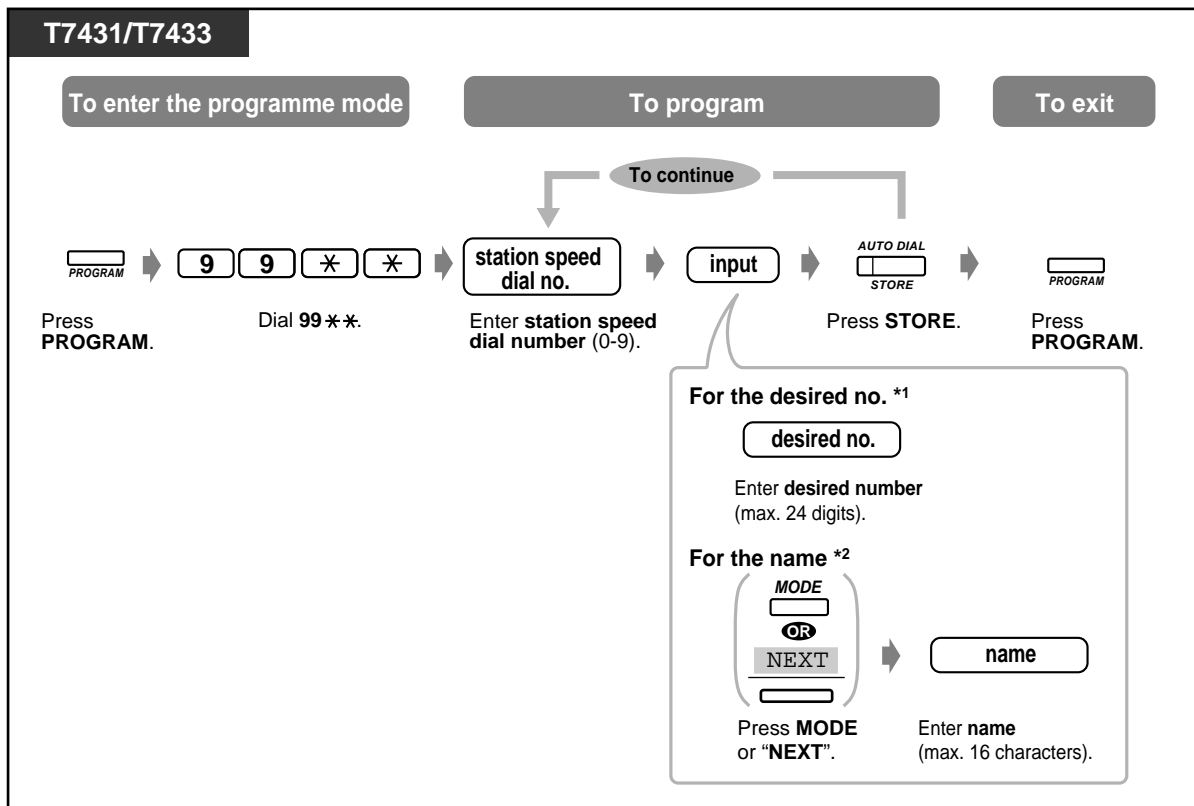

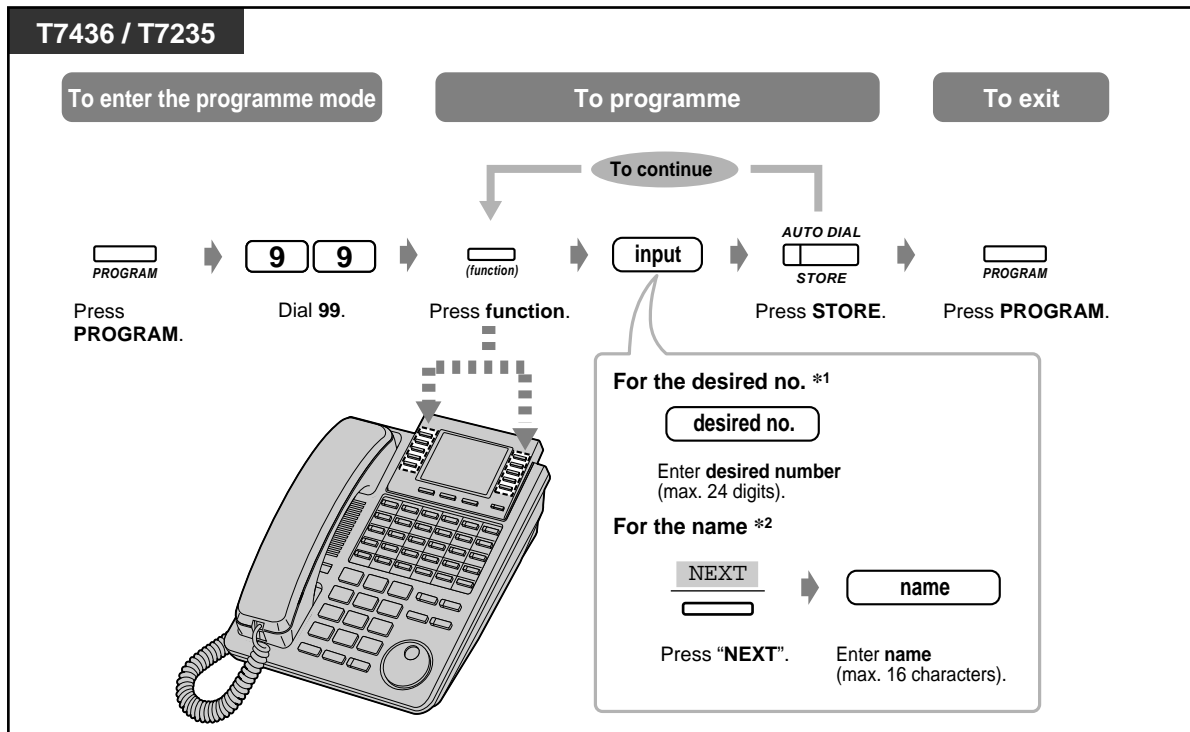

- *1 "*", "#", FLASH, PAUSE, SECRET (INTERCOM) and — (CONF) can also be stored.
- *2 To enter characters, Refer to "Character Entry" in 4.2.1 Customising Your System.
- The function buttons F1 through F10 correspond to station speed dialling numbers as follows:
 F1 — 0 F2 — 1 F3 — 2 F4 — 3 F5 — 4
 F6 — 5 F7 — 6 F8 — 7 F9 — 8 F10 — 9

◆◆ Display feature list

You can access the following features. These displays can be shown by rotating the Jog Dial or pressing the NEXT or PREV button after selecting "Features". For their operation, see the respective operating instructions in the list below.

Display (KX-T7436/KX-T7235)	Display (KX-T7431/KX-T7433)	Feature Description
Absent MSG Off	ABST MSG Off	Cancel the absent message. Refer to 2.6.4 Showing an Absent Message on the Caller's Telephone Display (Absent Message Capability).
Absent MSG On (1-9)	ABST MSG On 1-9	Set an absent message. Refer to 2.6.4 Showing an Absent Message on the Caller's Telephone Display (Absent Message Capability).
C.Pickup Group	C.Pickup GRP	Pick up a call within your extension group. Refer to 2.3.3 Answering a Call Ringing at Another Telephone (Call Pickup).
Call Park (0-9)	Call Park 0-9	Place a call on hold in a system parking area. Refer to 2.4.2 Holding a Call.
CM OGM PLAY (1-9)	CM OGM PLAY 1-9	Replay an outgoing message (OGM) for the company voice message box.* Refer to 3.2.3 Recording Company Greeting Outgoing Messages.
CM OGM REC (1-9)	CM OGM REC 1-9	Record an outgoing message (OGM) for the company voice message box.* Refer to 3.2.3 Recording Company Greeting Outgoing Messages.
CM OGM DEL (1-9)	CM OGM DEL 1-9	Delete an outgoing message (OGM) for the company voice message box.* Refer to 3.2.3 Recording Company Greeting Outgoing Messages.
COS Primary (ext)	COS Primary ext	Select the primary Class of Service (COS) mode for an extension*. Refer to 3.1.1 Switching Level of Service.
COS Secondary (ext)	COS Second ext	Select the secondary Class of Service (COS) mode for an extension*. Refer to 3.1.1 Switching Level of Service.

Display (KX-T7436/KX-T7235)	Display (KX-T7431/KX-T7433)	Feature Description
EXT OGM PLAY (1/2)	EXT OGM PLAY1/2	Replay an outgoing message (OGM) for the personal voice message box. Refer to 2.6.1 Built-in Voice Message.
EXT OGM REC (1/2)	EXT OGM REC 1/2	Record an outgoing message (OGM) for the personal voice message box. Refer to 2.6.1 Built-in Voice Message.
EXT OGM DEL (1/2)	EXT OGM DEL 1/2	Delete an outgoing message (OGM) for the personal voice message box. Refer to 2.6.1 Built-in Voice Message.
Extrn BGM On/Off	Ext-BGM On/Off	Turn on/off the background music.* Refer to 3.2.2 Turning on the External Background Music.
Message Off (ext)	MSG Off ext	Cancel a notification. Refer to 2.2.4 When the Dialed Line is Busy or There is No Answer.
Message On (ext)	MSG On ext	Leave a notification so that the called party may call you back. Refer to 2.2.4 When the Dialed Line is Busy or There is No Answer.
Night Auto/On/Off (0-2)	Night Mode 0-2	Change the night service mode; auto, night (On) or day (Off). (Pre-assigned extension can also change the mode.) Refer to 2.8.11 Day/Night Service.
Page-Ext Answer	Page-E ANS	Answer the paged announcement through a speaker. Refer to 2.3.4 Answering a Call via an External Speaker (Trunk Answer From Any Station [TAFAS]) and 2.7.3 Answering a Paged Announcement.
Page-GRP Answer	Page-GRP ANS	Answer the paged announcement through a telephone in the same extension group. Refer to 2.7.3 Answering a Paged Announcement.
Paging External	Page Extrn	Page through the speaker. Refer to 2.7.1 Paging.
Paging Group (0-8)	Page GRP 0-8	Page to all or a particular extension group. Refer to 2.7.1 Paging.

Display (KX-T7436/KX-T7235)	Display (KX-T7431/KX-T7433)	Feature Description
Parallel On/Off (1/0)	Parallel 1/0	Set whether a single line telephone connected in parallel will ring (On) or not (Off) when receiving a call. Refer to 2.8.13 Setting the Parallel Connected Telephone Ringer (Paralleled Telephone).



* The message is shown for the operators only.

Call Forwarding/Do Not Disturb feature:

You can also access the Call Forwarding and Do Not Disturb features. Go off-hook and press the FWD/DND button. You will see the following displays. For their operation, see the respective operating instructions. The KX-T7436 and the KX-T7235 users only use this display operation.

FWD/DND Cancel
DND (→0/*/ext)
FWD-All Calls (→ext)
FWD-Busy (→ext)
FWD-No Answer (→ext)
MENU PREV NEXT

FWD-BSY/NA (→ext)
FWD-CO Line (→dial)
FWD-From (→ext)
FWD-From Cancel (→ext)
FWD-NA-CO Line (→dial)
MENU PREV NEXT

2.11 Accessing the Internet (Internet Access)

2.11.1 Accessing the Internet (Internet Access)

You can connect to the Internet as the configuration on the right side.
KX-TD612 can work like an ISDN modem. But, the functions are restricted compared with an ISDN modem. For example, only the typical connection protocol to the Internet (PPP protocol) is supported, and the communication speed is not assured. For detailed information, consult your dealer.

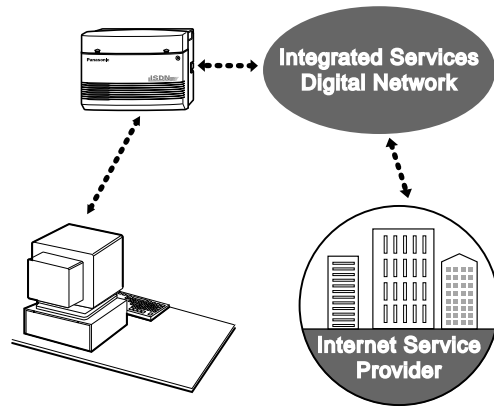

Section 3

Operator Operation

This chapter shows the operators how to control the extensions or the system. Your system supports up to 2 operators.

3.1 Extension Control

3.1.1 Switching Level of Service

You can switch either primary or secondary level of service for each extension.

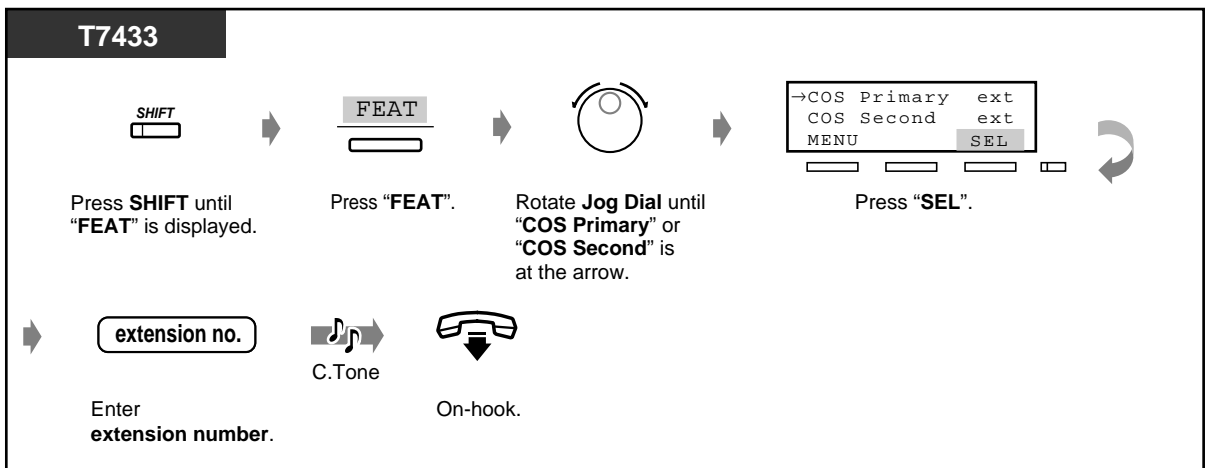
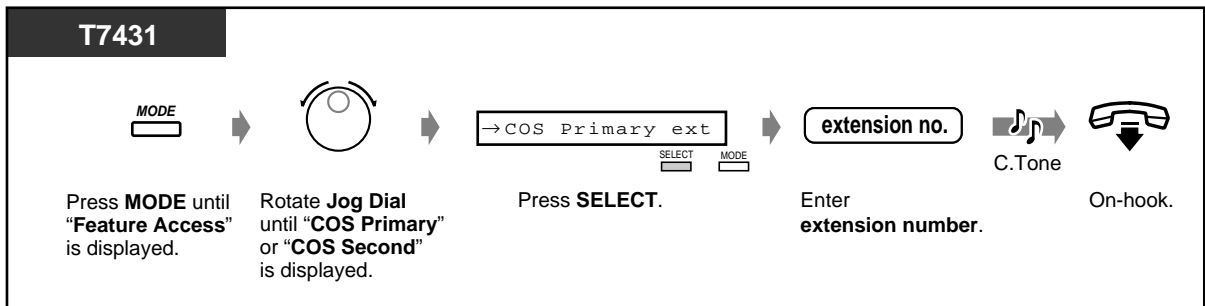
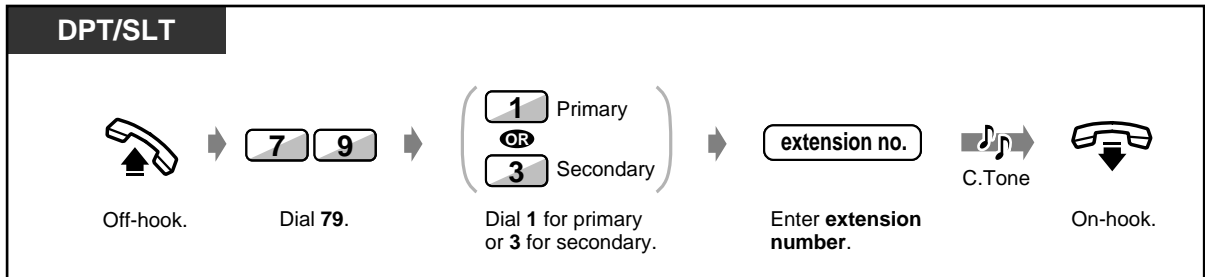

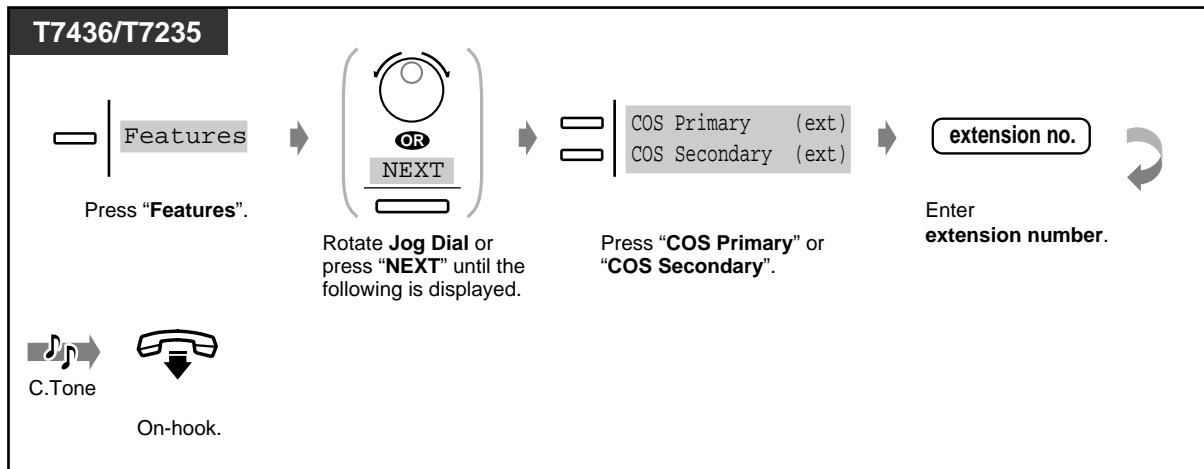

3.1.2 Changing the Settings

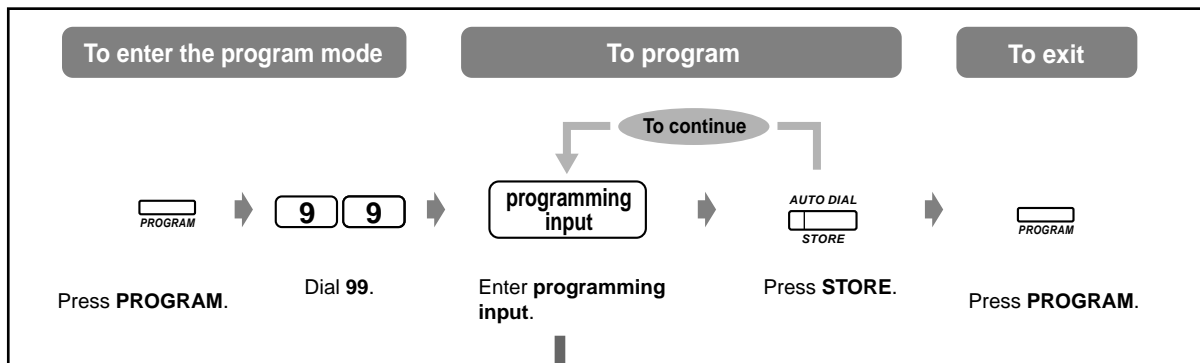

Item	Programming Input
Unlocking or locking any extension (Remote Station Lock Control)	0 1 extension no.* X X=1 : Unlock 2 : Lock
Unlocking the call log (Incoming Call Log Lock Control)	0 2 extension no.*
Clearing the Live Call Screening Password (Live Call Screening Password Control)	0 3 extension no.*



* To assign all extensions, press the "*" key.

3.2 System Control

3.2.1 Forwarding a Waiting Call (Automatic Overflow/Hurry-up Transfer)

When you (operator 1) are busy and an outside call comes to you directly, that call is put in a waiting queue. When the number of calls in the queue exceeds the assigned limit, calls will automatically be forwarded to operator 2. You can check the condition of the queue with the Hurry-Up button light, and forward the first call in the queue to a pre-assigned extension.



◆ To forward

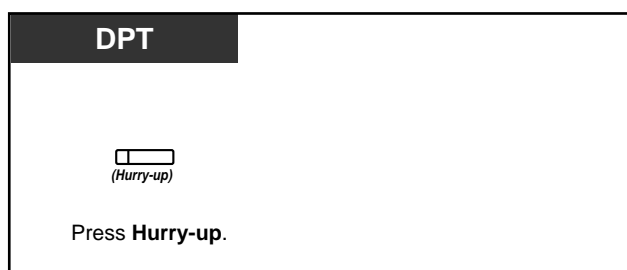

- The Hurry-Up button light shows the current status as follows:

Off: No waiting call

Red: At least 1 call is waiting.

Flashing red: Number of calls exceeds assigned limit.



Customising Your Phone

- 4.1.3 Customising the Buttons
Create or re-arrange a Hurry-Up button.

3.2.2 Turning on the External Background Music

You can broadcast background music in your office through external speakers.

◆ **To start/stop background music**

DPT/SLT

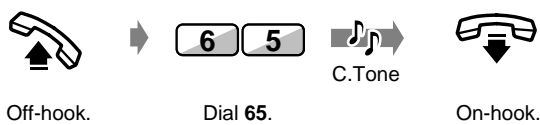

Off-hook. Dial **65**. C.Tone On-hook.

T7431

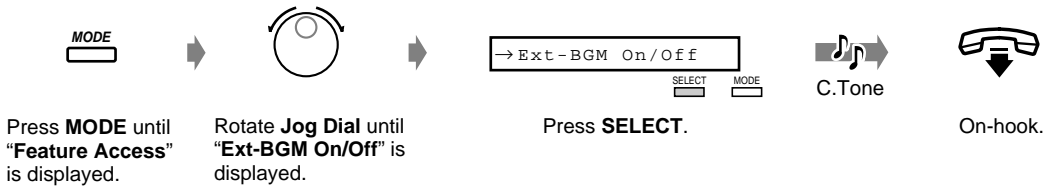

Press **MODE** until "Feature Access" is displayed. Rotate **Jog Dial** until "Ext-BGM On/Off" is displayed. Press **SELECT**. C.Tone On-hook.

T7433

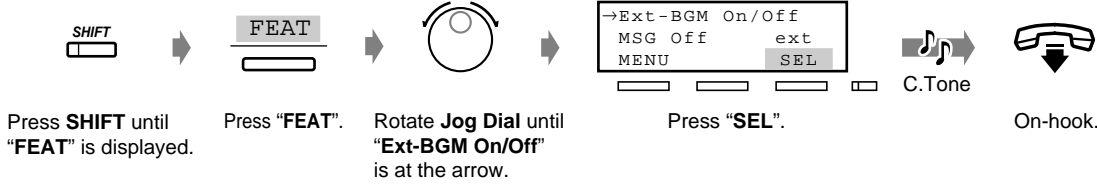

Press **SHIFT** until "FEAT" is displayed. Press "**FEAT**". Rotate **Jog Dial** until "Ext-BGM On/Off" is at the arrow. Press "**SEL**". C.Tone On-hook.

T7436/T7235

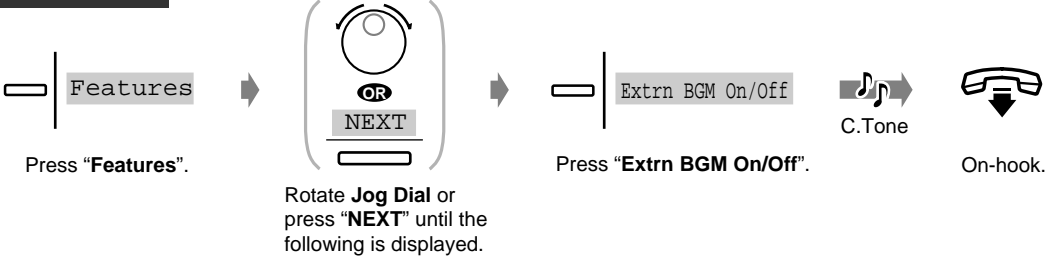

Press "**Features**". Rotate **Jog Dial** or press "**NEXT**" until the following is displayed. Press "**Extrn BGM On/Off**". C.Tone On-hook.

3.2.3 Recording Company Greeting Outgoing Messages

This function is only available an optional card KX-TD61291 is installed in the main unit KX-TD612. The operator can record/replay/delete the outgoing messages (OGM) for the company message box. The maximum time for one OGM is programmable from 1 minute to 15 minutes. (Default : 3 minutes) Ask your dealer.

◆ To record OGM for outside incoming call

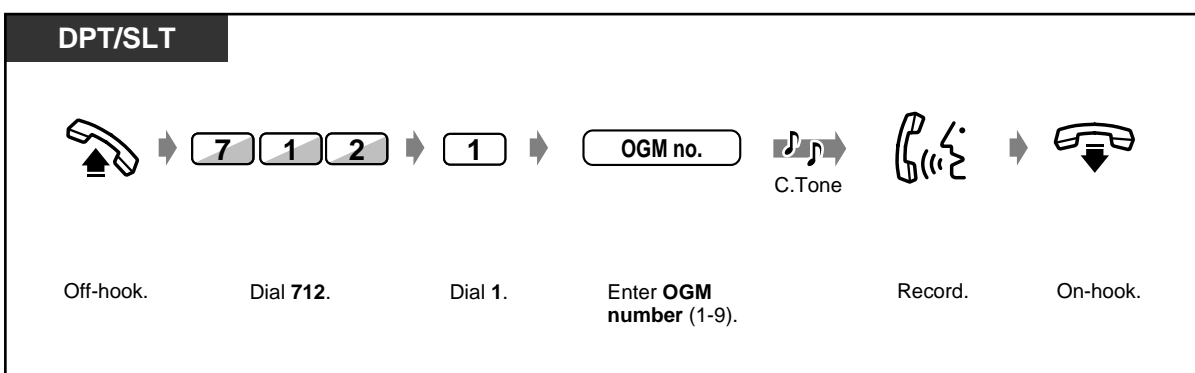
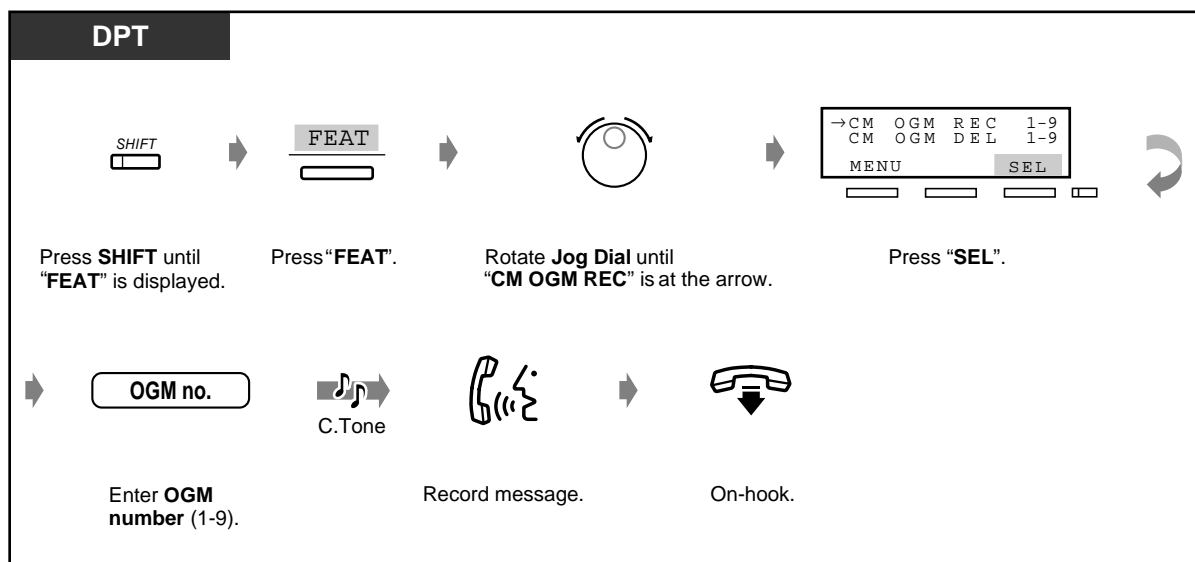

◆ **To replay OGM for outside incoming calls**

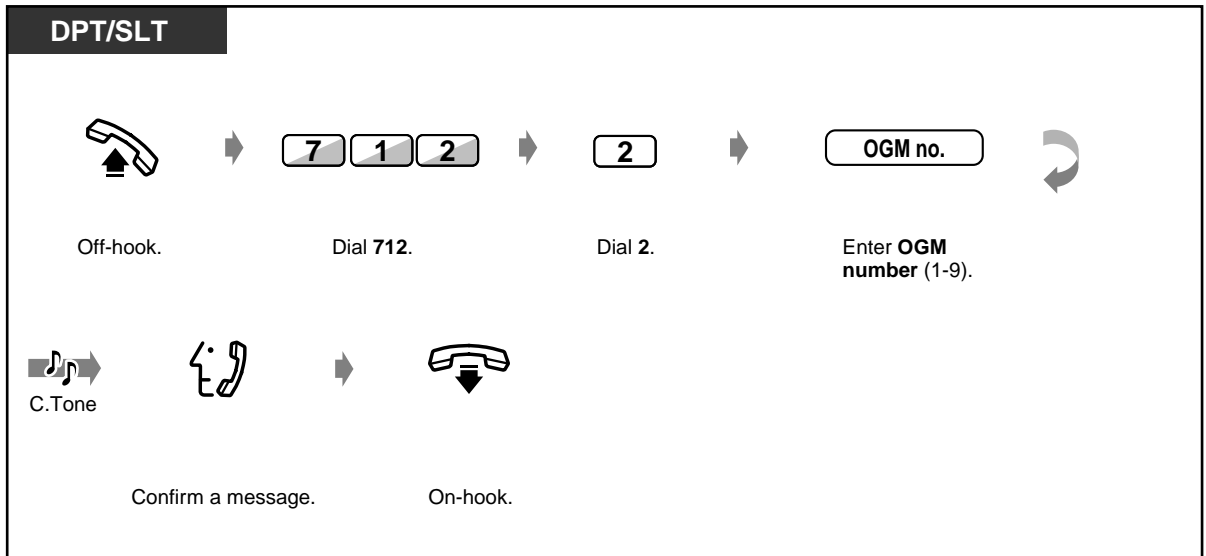
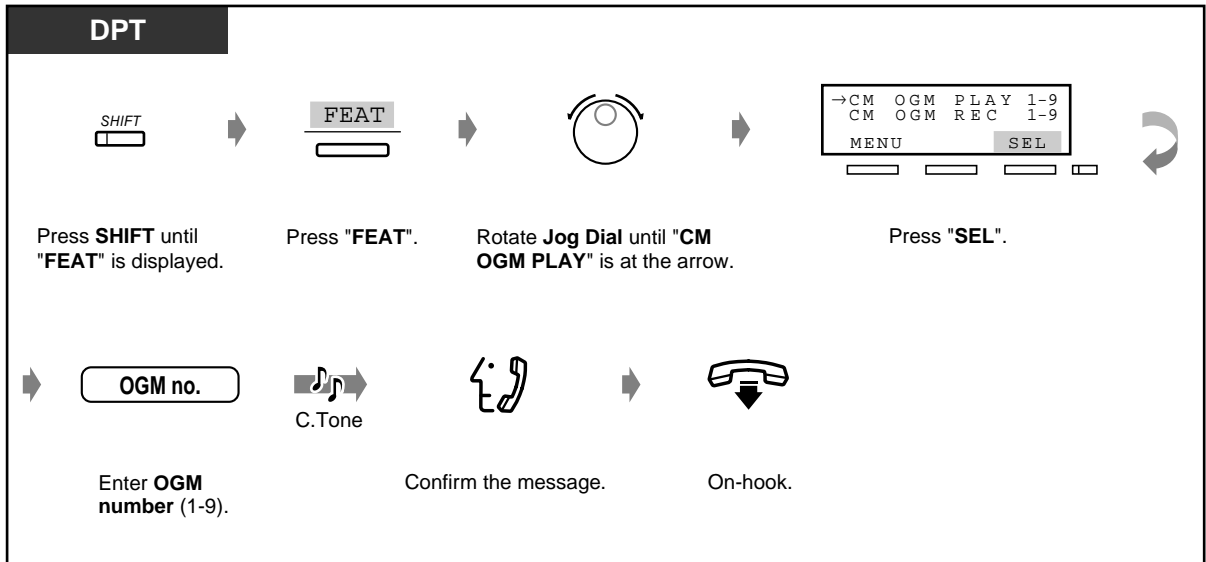

◆ **To delete OGM for outside incoming calls**

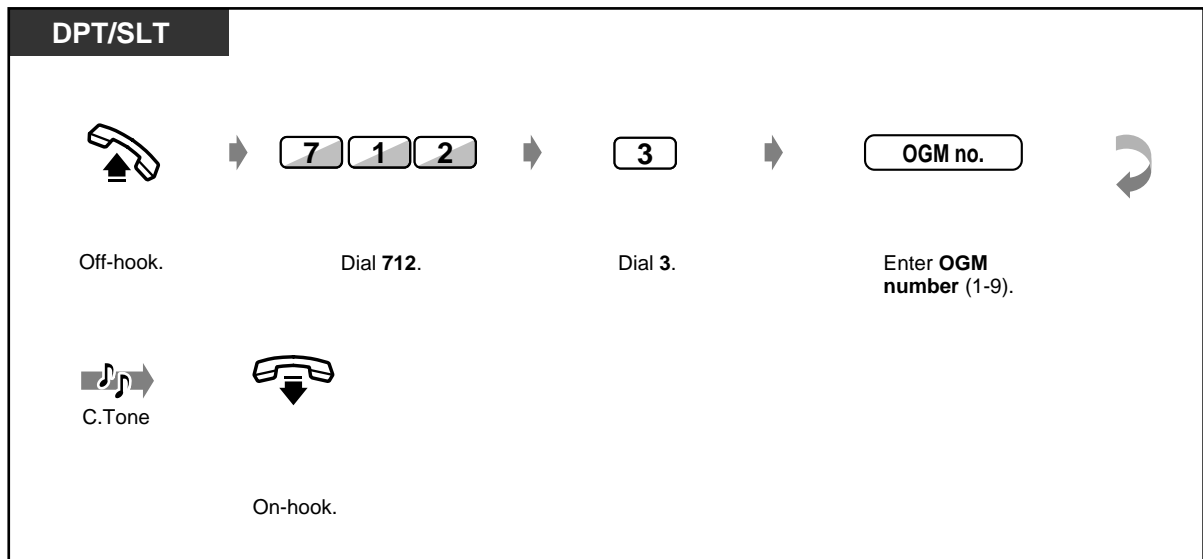
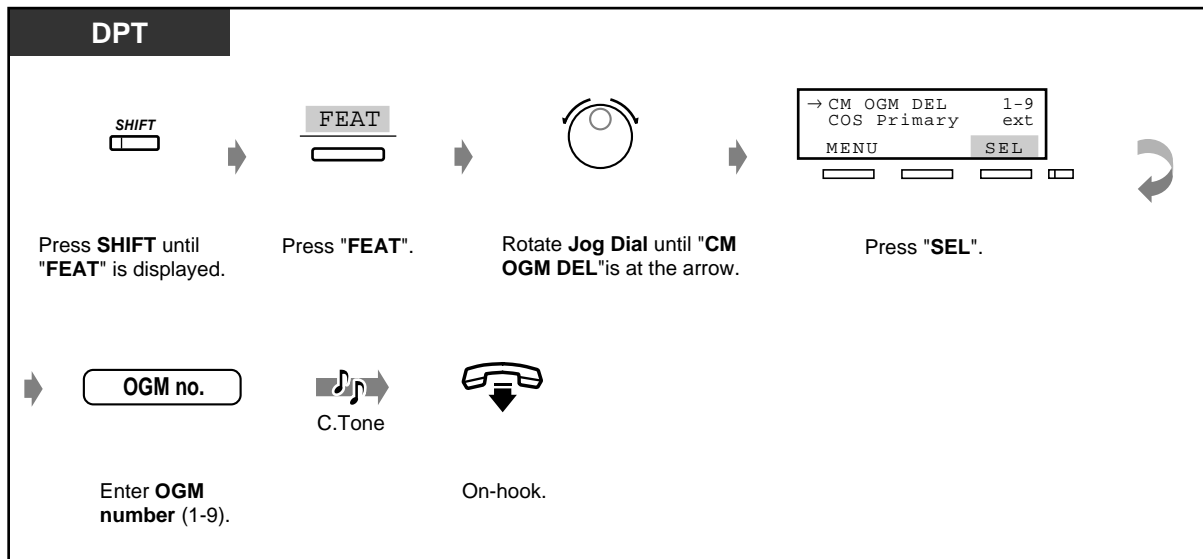

- You can record or delete an OGM only when no one else is using this feature such as replaying/recording/deleting a voice message or an OGM. If you try to record an OGM when someone else is using this feature, you will hear a reorder tone, and OGM BUSY will be indicated on the display (for Digital Proprietary Telephone user only).

3.2.4 Using the ANSWER/RELEASE Button [KX-T7441 only]

The ANSWER and RELEASE buttons on the Console are convenient for operators using headsets. With the ANSWER button, you can answer all incoming calls to the paired telephone. With the RELEASE button, you can disconnect the line during or after a conversation, or complete transferring a call.

◆ **To answer**



◆ **To transfer a call**

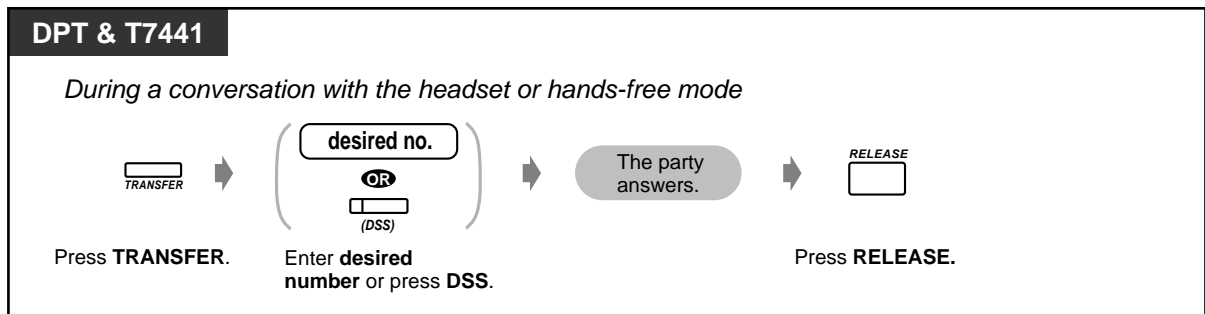

◆ **To transfer an outside call to an extension with one-touch**

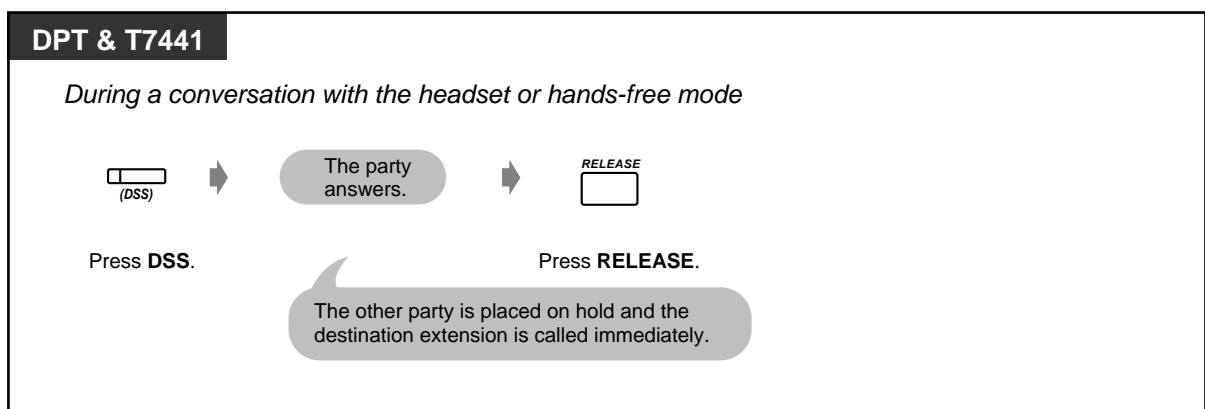

3.2.5 Printing the System Working Report

The system working report contains the following:

- The number of incoming calls and answered calls
- The percentage of answered calls versus all incoming calls
- The number of accesses requested and successful calls
- The percentage of successful calls versus tries
- The average call duration

This report can also be printed out by the manager.

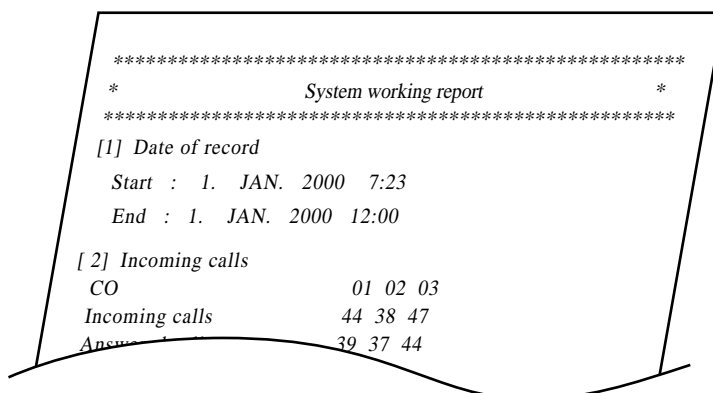
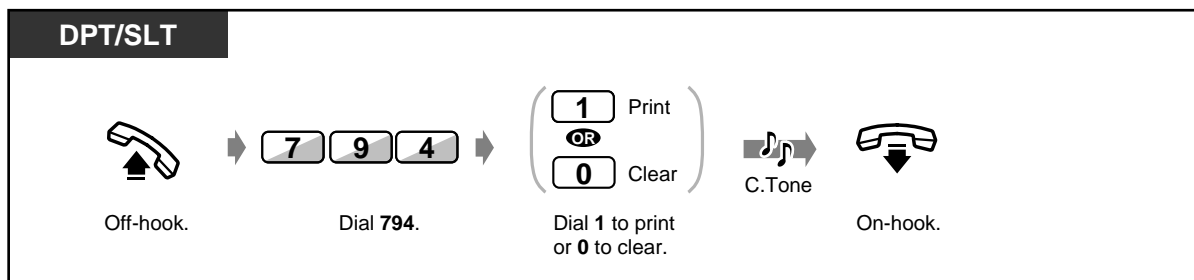

- This is not available for a SLT which is in the XDP connection.

Section 4

Customising Your Phone & System

This chapter shows you how to customise your individual telephone or system according to your needs. Find the desired setting and programme as necessary.

4.1 Customising Your Phone (Station Programming)

4.1.1 Customising Your Phone (Station Programming)

If you use a Panasonic digital proprietary telephone (e.g. KX-T7436), you can customise your telephone functions. For example, you can change the initial settings or button functions according to your needs.



- If you change your desks and the extension line, clear all settings first. The old settings will remain in the previous extension user's memory.

4.1.2 Initial Settings

The original settings are shown in bold letters in the shaded boxes. Find and mark your desired selections for programming.



- If nothing is entered within 1 minute in the programming mode, the mode returns to the normal status.
- To exit the mode at any time, lift the handset.

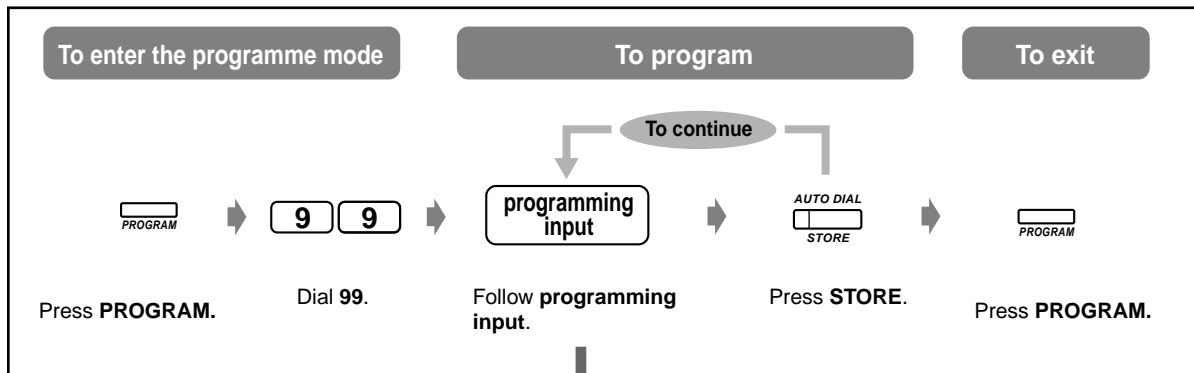

Item	Selection	Programming Input
Which line do you prefer to seize when you go off-hook to make calls? (Preferred Line Assignment - Outgoing)	<input type="checkbox"/> No line	1 1
	<input type="checkbox"/> An idle outside line	1 2
	<input type="checkbox"/> A pre-assigned outside line	1 3 Outside line no. (1-4)
	<input type="checkbox"/> The Intercom line	1 INTERCOM
Which line do you prefer to seize when you go off-hook to receive calls? (Preferred Line Assignment - Incoming)	<input type="checkbox"/> No line	2 1
	<input type="checkbox"/> A ringing line	2 2
	<input type="checkbox"/> A pre-assigned outside line	2 3 Outside line no. (1-4)
Which way do you prefer to dial the One-Touch Dialling feature? (Full One-Touch Dialling Assignment)	<input type="checkbox"/> Going Off-hook and then pressing the One-Touch Dialling button.	3 1
	<input type="checkbox"/> Pressing the One-Touch Dialling button.	3 2

Item	Selection	Programming Input
Which way do you prefer to receive an intercom call? (Intercom Alert Assignment)	<input type="checkbox"/> Ringing	4 1
	<input type="checkbox"/> Directly – the party's voice is heard without ringing.	4 2
Do you prefer to distinguish the Call Waiting tone from an outside line and an intercom call? (Call Waiting Tone Type Selection)	<input type="checkbox"/> No. Use the same tone. (Outside=Intercom=Tone1)	5 1
	<input type="checkbox"/> Yes. Use a different tone. (Outside=Tone2, Intercom=Tone3)	5 2
Do you prefer to hear the key tone? * (Key Click Tone On/Off Assignment)	<input type="checkbox"/> No	7 1
	<input type="checkbox"/> Yes	7 2
Which equipment will you use as a receiver? (Handset/Headset Selection)	<input type="checkbox"/> Handset	8 1
	<input type="checkbox"/> Headset	8 2
Which voice mail service do you prefer when a caller is recording a message in your mailbox? (Live Call Screening Mode Set)	<input type="checkbox"/> You can monitor the message through the telephone speaker. (Hands-free mode)	* 1 1
	<input type="checkbox"/> Only an alert tone is heard. (Private mode)	* 1 2



- * Even though you set the Key Click Tone assignment "on", the Key Click Tone will not be heard when the Background Music feature has been set "off".

◆◆ **To confirm the current setting**

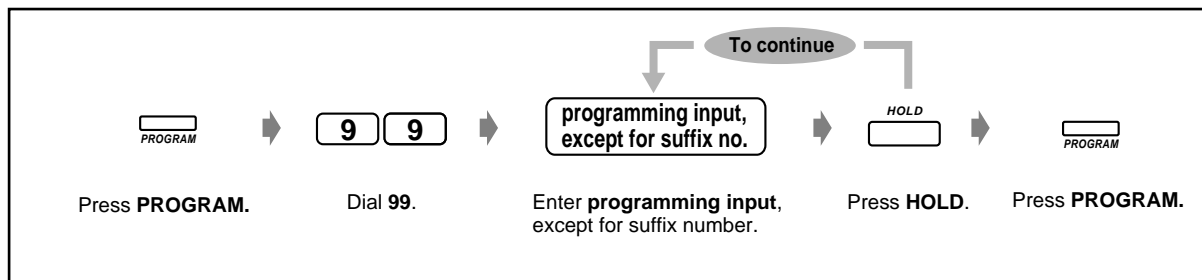

◆◆ **To clear all settings**

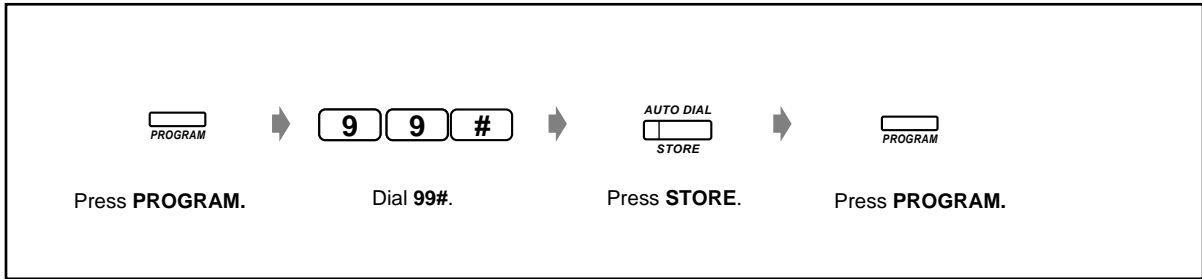

4.1.3 Customising the Buttons

You can change the flexible CO buttons, DSS buttons and programmable function (PF) buttons to the following function buttons. For example, if your telephone has more CO buttons than available CO lines, you may change an unused CO button to a one-touch dialling button.

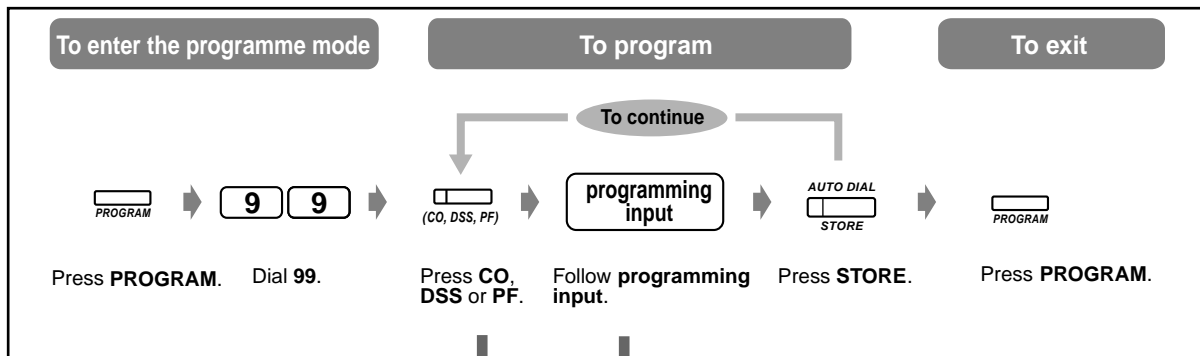

Button	Programmable Button			Programming Input
	CO	DSS	PF	
Loop-CO	✓			[*]
Single-CO	✓			[0] Outside line no. (1-7)
Direct Station Selection (DSS)	✓	✓		[1] Extension no.
One-Touch Dialling	✓	✓	✓	[2] Desired no.* ¹ (max. 24 digits)
MESSAGE	✓	✓		[3] [0]
DDI/CLIP	✓			[3] [1] System Speed Dialling 000-699
FWD/DND (Forward/Do Not Disturb)	✓	✓	✓	[4]
SAVE	✓	✓	✓	[5]
Account	✓	✓	✓	[6]
CONF (Conference)	✓	✓	✓	[7]
Log-In/Log-Out* ²	✓			[8] [0] FENOH* ⁵
Hurry-Up	✓			[8] [1] Extension no.
Voice Mail Transfer* ³	✓	✓	✓	[8] [2] Voice mail extension no.
Two-Way Record* ³	✓	✓		[8] [3] Voice mail extension no.

Button	Programmable Button			Programming Input				
	CO	DSS	PF					
Two Way Transfer * ³	✓	✓		8	4	Voice mail extension no.		
Live Call Screening * ³	✓	✓		8	5			
Live Call Screening Cancel * ³	✓	✓		8	6			
Phantom Extension	✓	✓		8	8	Phantom extension no.		
ISDN Service Key	✓	✓	✓	8	9	ISDN Service no. (max. 24 digits)		
Night* ²	✓	✓		8	*	0	0	
Call Pickup Deny* ²	✓	✓		8	*	0	1	
Call Waiting* ⁴	✓	✓		8	*	0	2	
Calling Line Identification Restriction (CLIR)* ²	✓	✓		8	*	0	3	
Connected Line Identification Restriction (COLR)* ²	✓	✓		8	*	0	4	
Do Not Disturb for Intelligent Call Handling 1:1 Call	✓	✓		8	*	0	5	
Executive Busy Override Deny* ²	✓	✓		8	*	0	6	
Paging Deny* ²	✓	✓		8	*	0	7	
Paralleled Telephone Connection* ²	✓	✓		8	*	0	8	
Pickup Dialling* ²	✓	✓		8	*	0	9	
Call Forwarding from Hunting Group* ²	✓	✓		8	*	1	0	Forwarding FENOH * ⁵
Doorphone Call Forwarding to Outside Line* ²	✓	✓		8	*	1	1	Doorphone no. (1-3)
One-Touch Dialling with Auto Hold	✓	✓	✓	8	#	Desired no.* ¹ (max. 24 digits)		
Terminate	✓	✓	✓	9				



- *1 *, #, FLASH, PAUSE, SECRET (INTERCOM) and — (CONF) can also be stored.
 If you do not want to display the stored number, press the SECRET (INTERCOM) button before and after the numbers you wish to conceal.
 If you store an external party's number, you should first store a line access number (9, 81 to 84).
 If you need to enter an account code, you can enter the specified account code before the line access number.
 <Example>

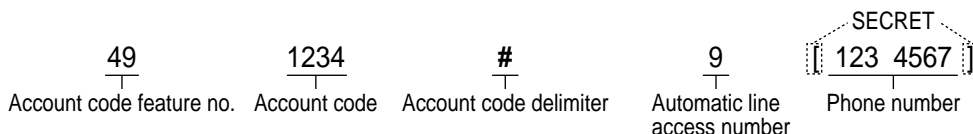

- *2 Pressing this button while on-hook or hearing a dial tone changes the setting (on or off) of the corresponding feature.
- *3 These buttons are used for the voice mail integration feature.
- *4 Pressing this button changes the settings as follows.

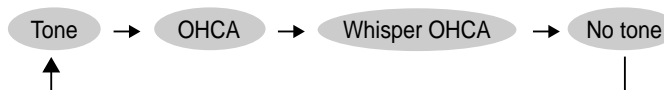

- *5 FENOH: Floating Extension Number of Hunting Group.
- **To exit the mode at any time**, lift the handset.

◆◆ **To make the ringing tone of each CO button distinctive**

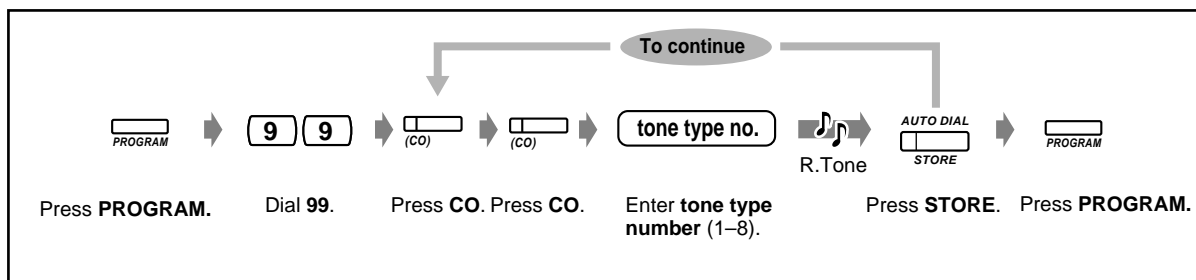

- You can assign a ringer frequency to CO buttons that are customised as Single-CO, Loop-CO or DDI/CLIP keys.

◆◆ **To change the ringing tone for intercom calls**

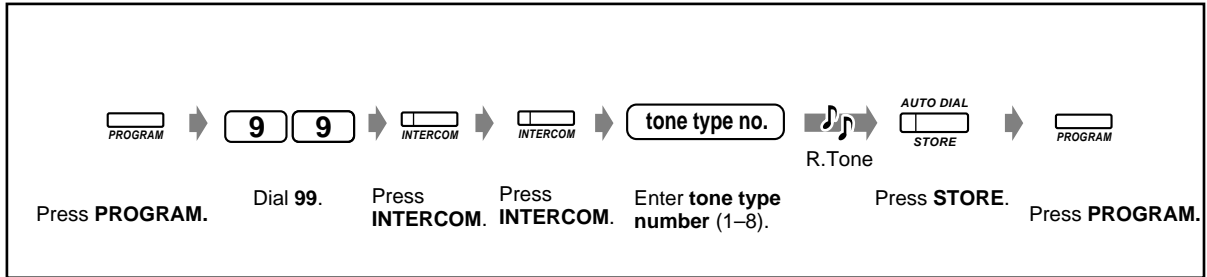

◆◆ **To set a phantom ringing on or off at an extension**

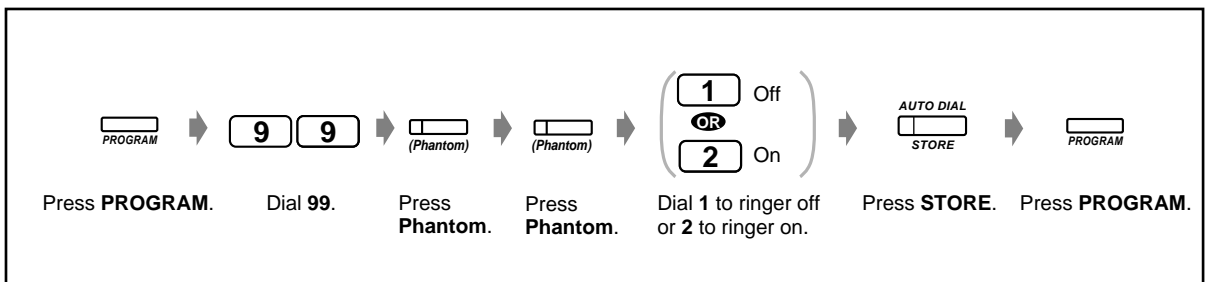

◆◆ **To clear the button data**

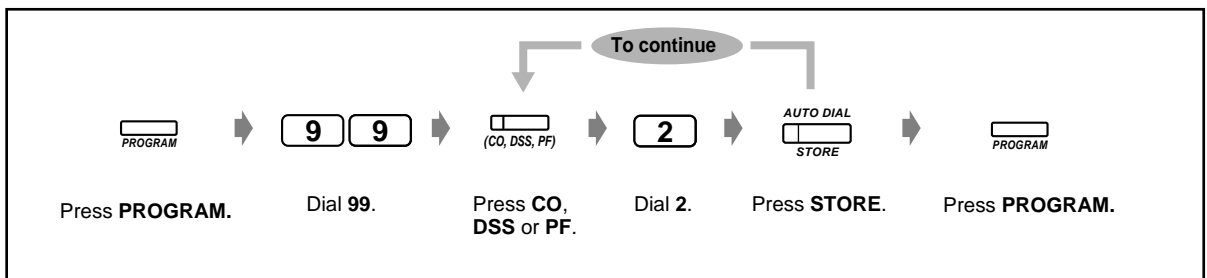

4.1.4 Charge Fee Management [Pre-assigned extension only]

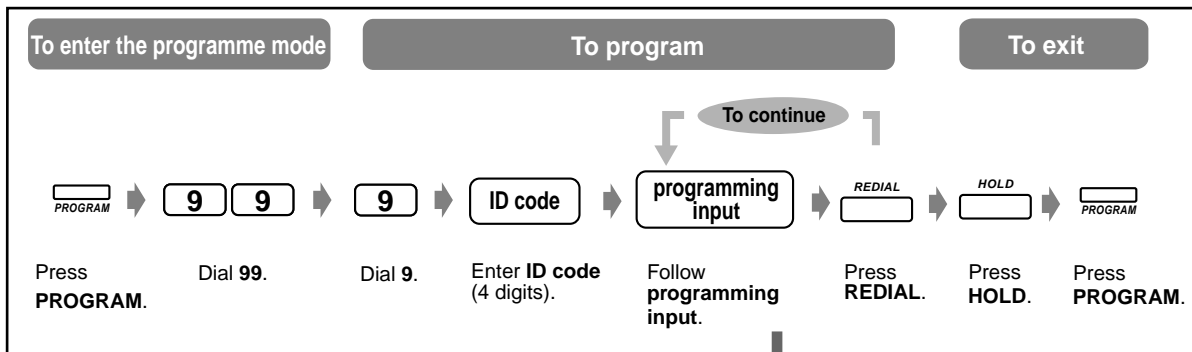

Item	Programming Input
Viewing each extension charge.	1 Extension no. <input type="text"/> SEL *
Clearing each extension charge.	1 Extension no. <input type="text"/> CLR <input type="text"/> AUTO DIAL STORE
Viewing each outside line charge.	2 Outside line no. (1-6) <input type="text"/> SEL *
Viewing the total charge.	3 <input type="text"/> SEL *
Viewing each account code charge.	4 Account table no. (01-64) <input type="text"/> SEL *
Clearing each account code charge.	4 Account table no. (01-64) <input type="text"/> CLR <input type="text"/> AUTO DIAL STORE
Clearing all outside line, account code and department code charges.	6 <input type="text"/> CLR [Displays the last clearing date and time.] <input type="text"/> AUTO DIAL STORE
Clearing all extension charges.	6 <input type="text"/> NEXT <input type="text"/> CLR [Displays the last clearing date and time.] <input type="text"/> AUTO DIAL STORE
Printing the total telephone charge (each outside line, account code and department code charge), all extension charges or each extension charge by SMDR.	7 1 total telephone charge
	7 2 all extension charges
	7 3 Extension no. each extension charge
Assigning an account code.	8 Account table no. (01-64) <input type="text"/> CLR <input type="text"/> New account code (10 digits max.) <input type="text"/> AUTO DIAL STORE
Viewing each department code charge.	9 Department code <input type="text"/> SEL *
Clearing each department code charge.	9 Department code <input type="text"/> CLR <input type="text"/> AUTO DIAL STORE



- * Press **SEL** to alternate between raw-meter display and converted-currency display.
- When you use an account number whose table number is 01, the dialled number does not show up on the SMDR. The account code and charge are printed out, however.
- Charges that can be referred to on a display or by SMDR do not include the ones of the analogue CO line.

4.2 Customising Your System

4.2.1 Customising Your System

You can customise your system according to your application. You can control telephone conditions for each extension, extension group, Class of Service, etc. For example, you can restrict some extensions from calling external parties. Furthermore, the programmed data, such as system speed dialling, can be used by all extensions.

Your system already has default settings (factory installed). Most of the programming is done by your dealer. Consult your dealer about system applications and re-programming according to your needs. Only frequently changed programming items are shown in this manual. If you would like to change the following features, extensions which meet certain conditions can re-program them at any time.

The available programming is shown below (Programme number)

- The date and time (000)
- System speed dialling/Intelligent call handing numbers and names (001/002)
- Extension number and name (003/004)

Required Telephone

A Panasonic Digital Proprietary Telephone with display (e.g. KX-T7433, KX-T7436)

User Password

To enter the programming mode, a user password (4-7digits) is required. It should be programmed through system programming beforehand. Check your password (Default:1234).

WARNING

Warning to the customer regarding the system password.

- (1) Please maintain the secrecy of the password. Because a person who knows the password can easily take over the control of any PBX system in the market and he may proceed to commit toll fraud.
- (2) Please select the dealer whom you can trust for the installation and maintenance.
- (3) Please change the password periodically.
- (4) We strongly recommend that you set the system password to 7 digits for maximum protection against "hackers".

Conditions

Only 1 extension, which is on-hook and holding no calls, is available at a time. If another extension is programming, "Another in Use" is displayed.

List

Before programming, decide your selections and write them down in the list for each programming item. These are useful for easy programming and future reference. Your dealer also has programming tables which contain all of the assignments. You may ask for photo copies of these tables to be aware of the features/conditions available.

Overlay/Button Function

The overlay is a paper sheet which is included with the telephone.

In the programming mode, the button functions are different. The overlay shows the functions in the programming mode. Place the overlay on the telephone properly.

If your telephone display shows the necessary functions, the overlay may be not required.

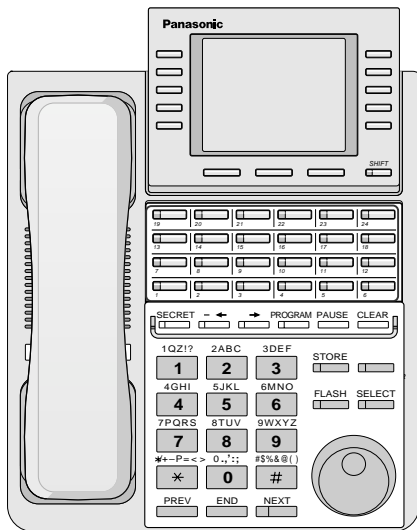

KX-T7436 with the overlay

Display

The display gives you useful messages about programming. The multiple-line display also shows the available functions. Follow the message at each step. This is a display sample in the initial programming mode.

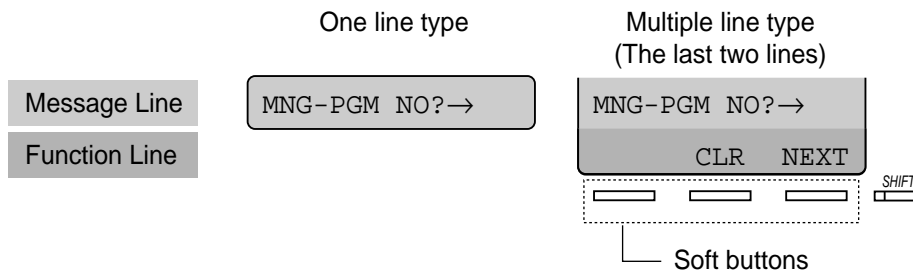

The message line guides you through programming and lets you confirm your selection. For example, when "Jack No? ->" is displayed, enter the jack number. The display shows up to 16 characters at a time. To scroll the display, press → or ←. The function line shows you the function of the Soft button located below it. When the SHIFT button light beside the display is on, subtitles are available. Press the SHIFT button to confirm the available functions.

Jack Number

Certain programming is assigned to each jack number. The jack number is where your telephone connects to the system. If two telephones share one jack and have their own extension number (eXtra Device Port [XDP]), the jack number is determined as Jack X-1 for a digital proprietary telephone and Jack X-2 for a single line telephone. The display may show X-2, even if an extension has not set XDP. **If you do not know the jack no.,** confirm it as shown below.

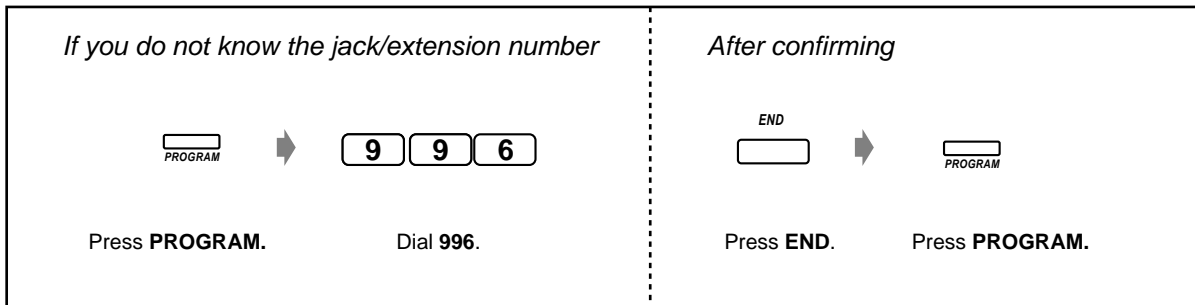

Confirmation

To confirm your entry after storing data;

- The STORE button light: Lights red.
- Confirmation Tone:
 - 1 beep: Your entry is accepted.
 - 3 beeps: Your entry is rejected.

Icon Descriptions

Icons are given to guide you through programming. The following is an example of how the icons may be used:

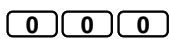

Enter the programme number. (xxx= the specified number)



Press the corresponding button on the telephone or the Soft button which corresponds to the display.

<Example>

NEXT : "NEXT" is displayed.

In this case, both of the following methods are available:

- Press the NEXT () button.
- Press the Soft button which corresponds to "NEXT" shown on the display.



The display messages "SEL+, SEL- and SEL" mean "SELECT". "CLR" means "CLEAR".



Press the button until the desired entry appears.



Enter your selection.

<Example>

jack no. : "Jack no." is displayed. Enter the jack number.

Procedure

The basic steps are shown below.

1. Entering the programming mode (The default of user password is 1234. Ask your dealer.)

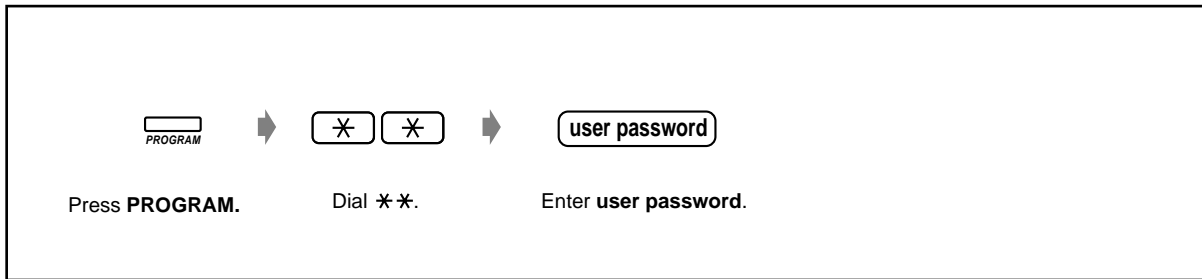

2. Programming

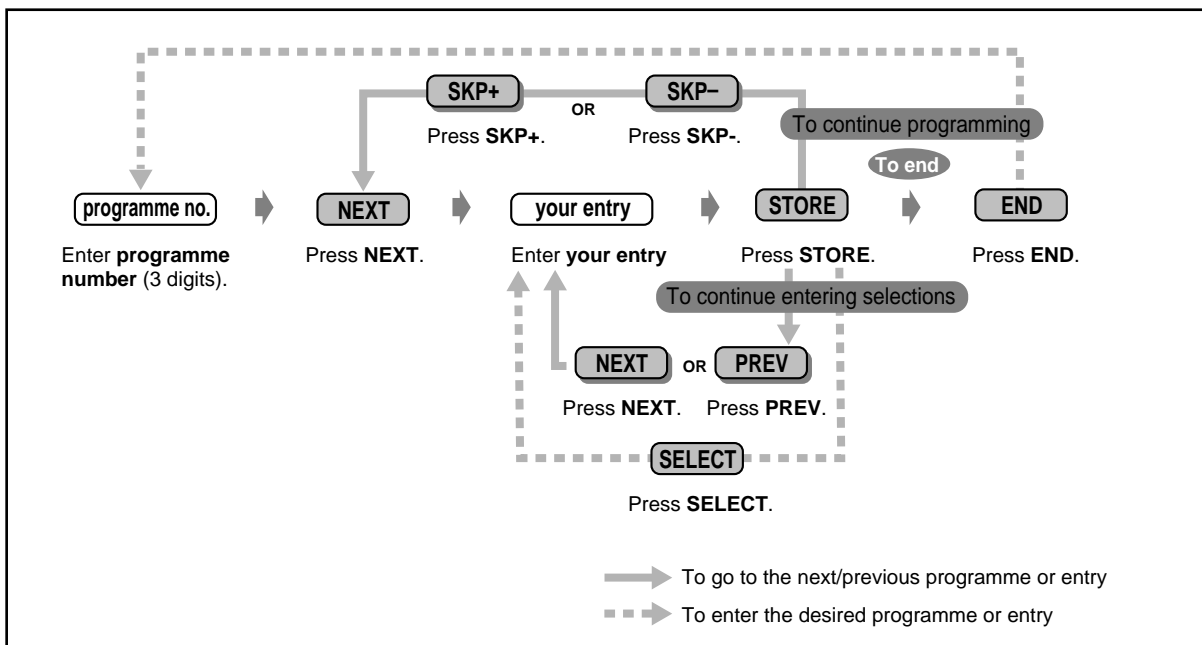

- **To delete or change an entry**, press CLEAR (TRANSFER).
- **To confirm your entry after storing data:**
 - The STORE button light: Lights red.
 - Confirmation Tone:
 - 1 beep: Your entry is accepted.
 - 3 beeps: Your entry is rejected.
- **To exit the programming mode at any time**, lift the handset.

3. Exiting the mode

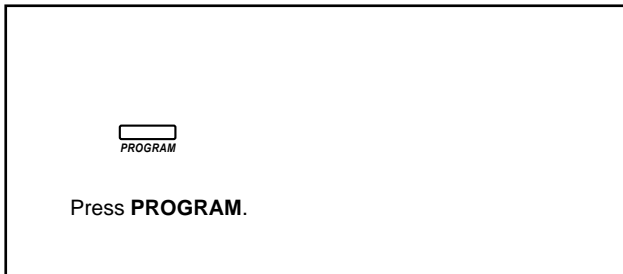

◆◆ Character Entry

When storing a name or message, enter the characters as follows. The tables below and on the next page show you the characters available for each key. You can enter letters by pressing the alphanumeric keys on your telephone. Example: Key 2 can enter A, a, B, b, C or c.

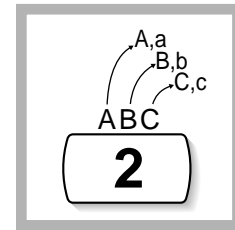

Entering characters

- Press the desired character key.
- Press the matching Soft button, press the SELECT* (AUTO ANSWER) button or rotate the Jog Dial as needed.
- Repeat the appropriate steps for the remaining characters.



- **To erase the last letter**, press the ← (CONF) button.
- **To erase all letters**, press the CLEAR (TRANSFER) button.
- **To alternate between capital and lower case letters**, press the SHIFT button. Once this button is pressed, the mode remains until the SHIFT button is pressed again.

* If your telephone is a KX-T7431, do not use the provided SELECT button. Use the AUTO ANSWER button which becomes the SELECT button when using the overlay.

Combination Table 1

Jog Dial keys	Display sequence by rotating the Jog Dial
1	1 Q q R r S s T t ...
2	2 A a B b C c D d ...
3	3 D d E e F f G g ...
4	4 G g H h I i J j ...
5	5 J j K k L l M m ...
6	6 M m N n O o P p ...
7	7 P p Q q R r S s ...
8	8 T t U u V v W w ...
9	9 W w X x Y y Z z ...
0	0 (space) ! ? . , ' : ; ...
*	* / + - = < > # \$...
#	# \$ % & @ () A a ...

Combination Table 2

Soft button		S1	SHIFT+S1	S2	SHIFT+S2	S3	SHIFT+S3	SHIFT+SHIFT+S1	SHIFT+SHIFT+S2
SELECT button pressing times	0	1	2	3	4	5	6	7	8
keys									
1	1	Q	q	Z	z	!	?		
2	2	A	a	B	b	C	c		
3	3	D	d	E	e	F	f		
4	4	G	g	H	h	I	i		
5	5	J	j	K	k	L	l		
6	6	M	m	N	n	O	o		
7	7	P	p	Q	q	R	r	S	s
8	8	T	t	U	u	V	v		
9	9	W	w	X	x	Y	y	Z	z
0	0	(space)	.	,	'	:	;		
*	*	/	+	-	=	<	>		
#	#	\$	%	&	@	()		

<Example> To enter "Ann",

A	n	n
– Using the Jog Dial 		
– Using a soft button. 		
– Using the SELECT button. 		

4.2.2 Date and Time Set (000)

After setting the current date and time, the digital proprietary telephone displays the current date and time while on-hook.

Default: 1 Jan '02 TUE 00:00

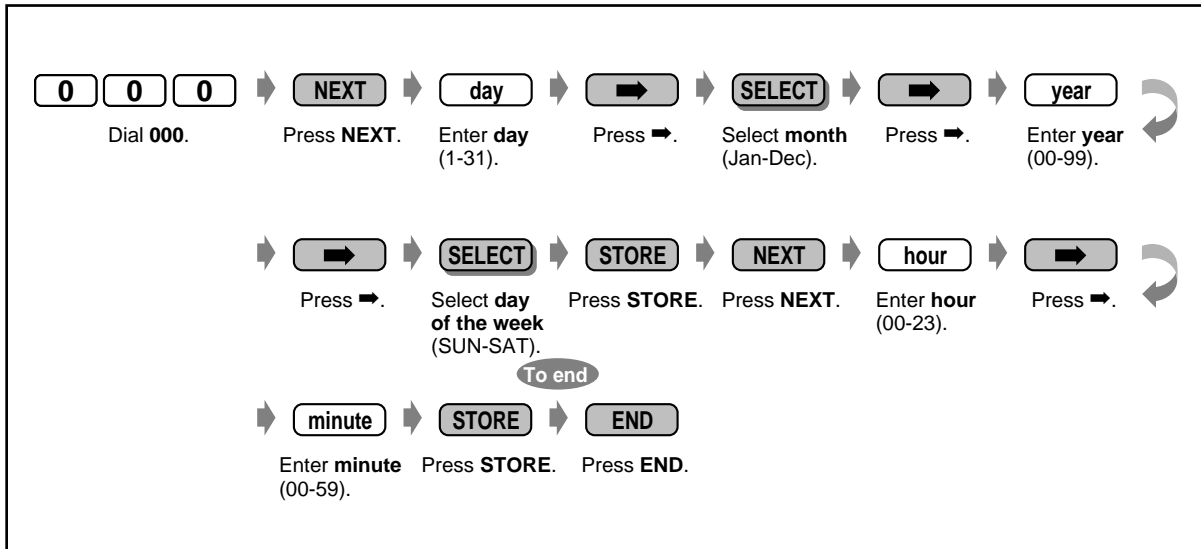

- **After changing the desired entries**, you can press the STORE button. You do not have to perform the rest of the steps.
- The clock starts immediately after the STORE button is pressed.
- You cannot leave an entry empty.

4.2.3 System Speed Dialling and Intelligent Call Handling Number Set (001)

You can store the phone number of up to 700 for 2 functions **Default** : No entry

System Speed Dialling Number (000 – 499): You can store the phone numbers of up to 500 frequently dialled numbers (max. 32 digits).

Intelligent Call Handling Number (000 – 699): Intelligent Call Handling distributes an incoming outside call to a specific extension/group in accordance with DDI/MSN number provided by Integrated Service Digital Network (ISDN) or caller's number (CLIP). Up to 500 CLIP numbers (000 – 499) and 200 DDI/MSN numbers (500 – 699) can be stored. CLIP number of a caller is analysed prior to DDI/MSN number. Searching order is from the lowest to the highest among 000 – 699. Consult your manager.

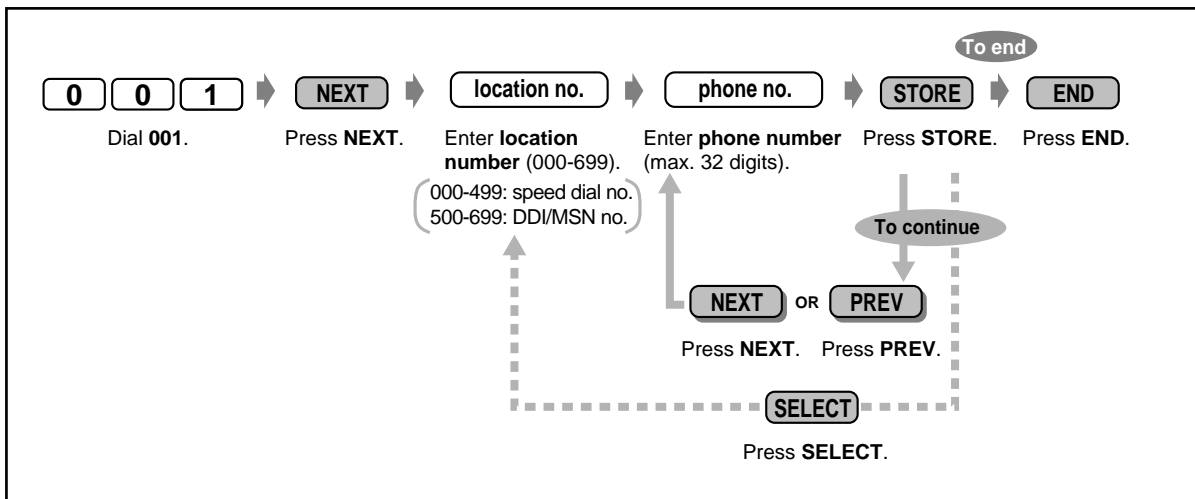

- Make use of "System Speed Dialling" in 5.3.1 Directory.
- If the desired number is more than 32 digits, divide the number and store it into 2 or more speed dial numbers.
- *, #, FLASH, PAUSE, SECRET (INTERCOM) and — (CONF) can also be stored.

If you do not want to display the stored number, press the SECRET (INTERCOM) button before and after the numbers you wish to conceal.

If you store an external party's number, you should first store a line access number (9, 81 to 84).

If you need to enter an account code, you can enter the specified account code before the line access number.

<Example>

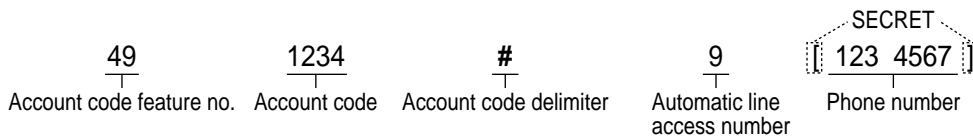



- You can assign CLIP and DDI/MSN numbers at System Speed Dialling locations 000-699. CLIP numbers can be assigned at the location 000-499. DDI/MSN numbers can be assigned at locations 500-699. We recommend that wild card numbers for CLIP be stored starting at location 499, and then 498, 497, etc. That is, go backwards numbers starting from 499.
We recommend the preceding because if you assign the wild card number "9-012*****" at location 000, then all calls that start with "012" will be processed according to that routing — even though you assign "9-0123456789" at another location. This is because the CLIP or your DDI/MSN number is analysed sequentially from 000 to 699.
- When you assign a wild card, be sure to enter the whole number. For example, when the telephone number has 10 digits and you want to assign an area code as the wild card, assign "9-012*****". ("012" is an example of an area code.)
- If you assign a wild card number at the locations 000-499, the name assigned in 4.2.4 System Speed Dialling and Intelligent Call Handling Name Set (002) will not be displayed when receiving the call. (Refer to 2.10.2 Recording a Call Log [KX-T7433, KX-T7436, KX-T7230, KX-T7235 only].)
- Up to 60 handling table numbers of Day/Night mode can be assigned for each 700 System Speed Dialling and Intelligent Call Handling number. The receiving pattern can be assigned for each handling table number. Intelligent Call Handling table number 61 and 62 are reserved to handle calls which the system cannot analyse. Be sure 61 (for day mode) is assigned to at least 1 extension and 62 (for night mode) is assigned to at least 1 extension. The destinations of 61 and 62 cannot be a floating extension, a phantom extension, or a voice mail extension.
- The System Speed Dialling/Intelligent Call Handling numbers are used for the call identification. For proper operation, a hyphen must be inserted after the line access number. Additionally, the area code must be stored always (even for local numbers in the same area).
- Up to 24 DDI/CLIP keys can be located at a CO button on a digital proprietary telephone. DDI/CLIP key is provided in accordance with CLIP and DDI/MSN call handling. Both of answering and making calls are possible with DDI/CLIP keys. Making a call with DDI/CLIP key is available for System Speed Dialling numbers stored in location 000-499.
- It is possible to make the ringing tone of each DDI/CLIP key distinctive. This allows the user of DPT without display to discriminate the caller of the incoming call. Refer to 4.1.3 Customising the Buttons.



Customising Your Phone

- 4.1.3 Customising the Buttons
Create or re-arrange a DDI/CLIP key.

4.2.4 System Speed Dialling and Intelligent Call Handling Name Set (002)

You can store the corresponding name of the speed dialling and DDI/MSN number. These names are displayed when receiving a call with the display operation. (See 2.10.3 Using the KX-T7431, KX-T7433, KX-T7436 or KX-T7235.) To enter characters, refer to "Character Entry" in 4.2.1 Customising Your System.

Default : No entry

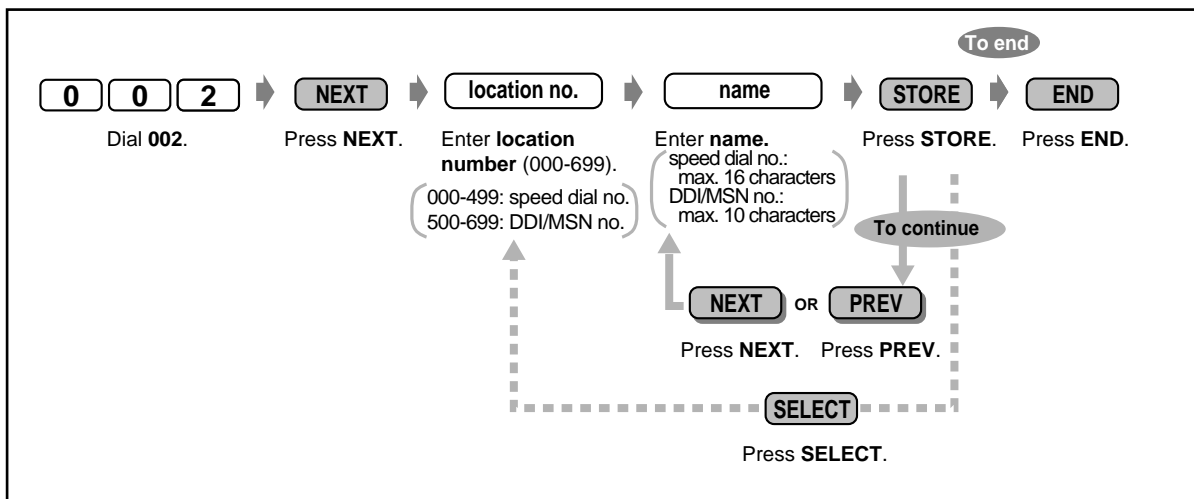

- Make use of "System Speed Dialling" in 5.3.1 Directory.
- If you assign a wild card number at the locations 000-499, name assigned in this programming will not be displayed when receiving the call. (Refer to 2.10.2 Recording a Call Log [KX-T7433, KX-T7436, KX-T7230, KX-T7235 only].)

4.2.5 Extension Number Set (003)

You can assign an extension number to each jack.

Default : Jack 1-1=201	Jack 1-2=301
Jack 2-1=202	Jack 2-2=302
Jack 3-1=203	Jack 3-2=303
Jack 4-1=204	Jack 4-2=304
Jack 5-1=205	
Jack 6-1=206	
Jack 7-1=207	
Jack 8-1=208	

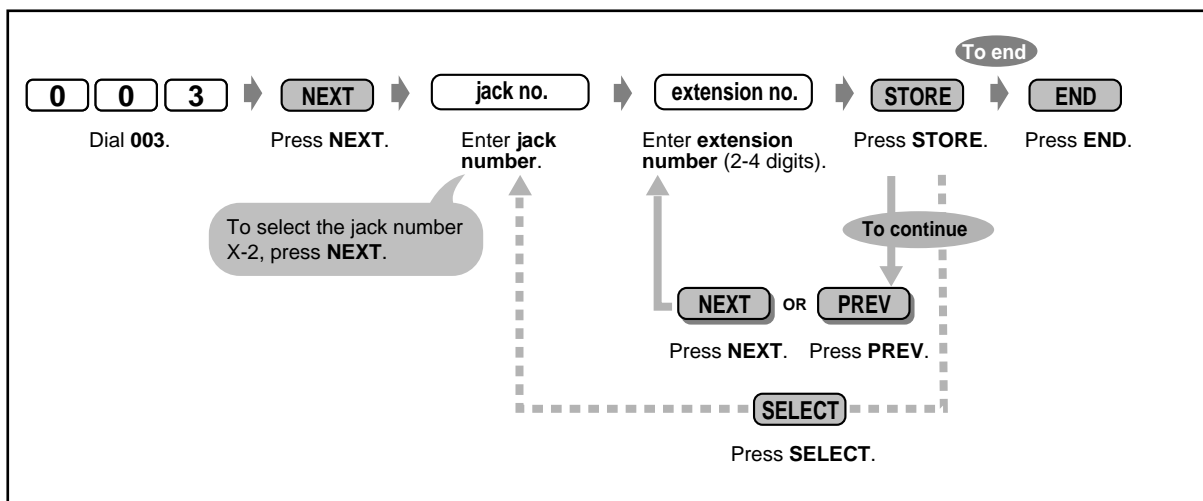

- The leading number(s) should be the same as the assigned number(s) for Flexible Numbering. Consult your dealer.
- A double entry is invalid.

4.2.6 Extension Name Set (004)

You can store the name of an extension user. This is useful if you want to know who is calling, or who you are calling when making an intercom call using the directory.

To enter characters, refer to "Character Entry" in 4.2.1 Customising Your System.

Default : No entry

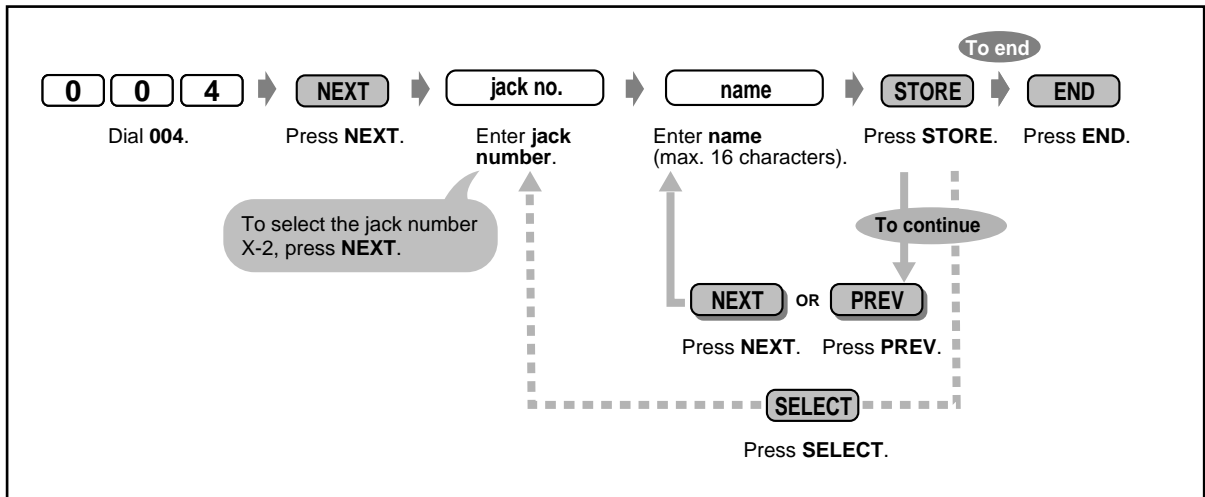

- The directory is on 5.3.1 Directory.

Section 5

Appendix

This chapter provides the Troubleshooting, Feature Number List, Directory, Tone List, Specifications and the Quick Reference Card for a Single Line Telephone. Check the Troubleshooting before consulting your dealer.

5.1 Troubleshooting

5.1.1 Troubleshooting

Note

If you use an analogue proprietary telephone, some features may not work properly. Consult your dealer.

Problem	Remedy
<p>The telephone does not work properly.</p>	<ul style="list-style-type: none"> • The wiring is wrong. ➔ Check the wiring. • The system does not work properly. ➔ Restart the system. (☞ 1.4.1 Adding Another Telephone in Parallel)
<p>I cannot use the telephone.</p>	<ul style="list-style-type: none"> • The telephone is locked. ➔ Unlock your telephone. (☞ 2.6.5 Preventing Other People from Using Your Telephone (Electronic Station Lockout), 3.1.2 Changing the Settings) • Your telephone is connected to an eXtra Device Port. ➔ System programming is required. Consult your dealer.
<p>Some features do not work.</p>	<ul style="list-style-type: none"> • System management may restrict certain features. ➔ Consult your manager. • The feature numbers have changed. ➔ Confirm the revised number and try again.
<p>Even though following the manual instructions, none of the operations work when using a digital proprietary telephone.</p>	<ul style="list-style-type: none"> • The Intercom line was not seized. The seized line, when going off-hook, was changed by personal setting. (☞ 4.1.2 Initial Settings) ➔ In the manual, going off-hook means an Intercom line is seized. If the setting has been changed, press the INTERCOM button after going off-hook and follow the instructions.
<p>The paralleled single line telephones do not ring.</p>	<ul style="list-style-type: none"> • This is the default setting. ➔ Change the setting to ring. (☞ 2.8.13 Setting the Parallel Connected Telephone Ringer (Paralleled Telephone))
<p>The telephone does not work using the personal settings or with other settings. (One-touch dialling, forwarding destination, etc.)</p>	<ul style="list-style-type: none"> • The extension line has been changed. The previous telephone's settings have not be cleared. ➔ Clear the settings and then program your desired settings again. (☞ 2.8.14 Clearing the Feature Settings at Your Extension (Station Programme Clear), 4.1.2 Initial Settings, 4.1.3 Customising the Buttons)

Problem	Remedy
<p>My digital proprietary telephone does not have a function button.</p>	<ul style="list-style-type: none"> • Some models do not have the function button. <ul style="list-style-type: none"> ➔ Change a flexible button to the desired button. (☞ 4.1.3 Customising the Buttons) ➔ Enter the specified feature number instead of the function button. (☞ 2.1.1 Before Operating the Telephones)
<p>I cannot make an outside call.</p>	<ul style="list-style-type: none"> • The telephone is locked. <ul style="list-style-type: none"> ➔ Unlock your telephone. (☞ 2.6.5 Preventing Other People from Using Your Telephone (Electronic Station Lockout), 3.1.2 Changing the Settings) • Toll restriction is activated. <ul style="list-style-type: none"> ➔ Consult your manager or dealer. • An account code is required. (☞ 2.2.5 Calling without Restrictions, 4.1.4 Charge Fee Management [Pre-assigned extension only]) • Nothing was dialed within 10 seconds after going off-hook. <ul style="list-style-type: none"> ➔ Hang up, off-hook and re-dial again.
<p>A reorder tone is audible or "Restricted" is displayed.</p>	<ul style="list-style-type: none"> • The telephone is locked. <ul style="list-style-type: none"> ➔ Unlock your telephone. (☞ 2.6.5 Preventing Other People from Using Your Telephone (Electronic Station Lockout), 3.1.2 Changing the Settings) • Toll restriction is activated. <ul style="list-style-type: none"> ➔ Consult your manager or dealer. • An account code is required. (☞ 2.2.5 Calling without Restrictions, 4.1.4 Charge Fee Management [Pre-assigned extension only])
<p>I cannot make an outside call using the One-Touch Dialling button or speed dialling.</p>	<ul style="list-style-type: none"> • A line access number was not stored. <ul style="list-style-type: none"> ➔ A line access number is required for outside calls. (☞ 2.2.1 Basic Calling, Refer to "Storing the names and numbers for station speed dialling" in 2.10.3 Using the KX-T7431, KX-T7433, KX-T7436 or KX-T7235, 4.1.3 Customising the Buttons)
<p>I cannot remember the feature numbers.</p>	<ul style="list-style-type: none"> ➔ Ask your dealer to change the feature numbers for easier use. ➔ Store the feature numbers into the One-Touch Dialling buttons. (☞ 4.1.3 Customising the Buttons)
<p>Redialling does not function.</p>	<ul style="list-style-type: none"> • The stored number was more than 24 digits or an extension number. (☞ 2.2.3 Redial)
<p>I do not want to show my identification number to the calling or called party's telephone.</p>	<ul style="list-style-type: none"> • (☞ 2.8.6 Preventing Your Number Being Displayed on the Called Party's Telephone (Calling Line Identification Restriction [CLIR]), 2.8.7 Preventing Your Number Being Displayed on the Calling Party's Telephone (Connected Line Identification Restriction [COLR]))

Problem	Remedy
I want to show my identification number to the calling or called party's telephone.	<ul style="list-style-type: none"> (☞ 2.8.5 Automatic Selection of Calling/Connected Line Identification Presentation (CLIP/COLP))
I cannot send a call waiting tone to the dialled extension.	<ul style="list-style-type: none"> • The other party has not set the Call Waiting feature. (☞ 2.2.4 When the Dialled Line is Busy or There is No Answer, 2.4.7 Answering a Call Waiting, 2.8.3 Receiving a Call Waiting (Call Waiting/Off-Hook Call Announcement [OHCA]/Whisper OHCA)) • The other party has set Data Line Security. ➔ consult your dealer.
I forgot the lock code/Live Call Screening Password.	➔ Ask the Operator or manager to assist you. (☞ 3.1.2 Changing the Settings)
The background music started suddenly.	➔ Turn off the music. (☞ 2.8.10 Turning on the Background Music, 3.2.2 Turning on the External Background Music)
I do not want to display a number which is stored in memory.	➔ Conceal the number. (☞ Refer to "Storing the names and numbers for station speed dialling" in 2.10.3 Using the KX-T7431, KX-T7433, KX-T7436 or KX-T7235, 4.1.3 Customising the Buttons)
The display does not show the message described in the manual.	<ul style="list-style-type: none"> • The telephone is not a Panasonic digital proprietary telephone. ➔ This manual shows messages which appear only on Panasonic digital proprietary telephones (e.g. KX-T7436). (☞ 2.1.1 Before Operating the Telephones)
I want to confirm my extension number and jack number.	(☞ 4.2.1 Customising Your System)
The date and time are not correct.	<ul style="list-style-type: none"> • Set the date and time by customising your system. (☞ 4.2.2 Date and Time Set (000))
The display is abnormal.	<ul style="list-style-type: none"> • The lithium battery for memory back-up needs to be replaced. ➔ Consult your dealer.
I want to make distinctive the ringing tones.	(☞ 4.1.2 Initial Settings, 4.1.3 Customising the Buttons)
The MESSAGE button light lit.	<ul style="list-style-type: none"> • There are three scenarios: (1) Someone left you a message waiting indication, or (2) someone left you a BV message, or (3) someone left you a voice mail message. Press the button to call back or receive the message.
"System Data Err 1" is displayed at the operator 1's telephone.	<ul style="list-style-type: none"> • There is a wrong system data with back up RAM for master system. ➔ Consult your dealer.

Problem	Remedy
"Check Printer" is displayed at the operator 1's telephone.	<ul style="list-style-type: none">• The paper of the printer runs out or the printer is out-of-service. ➔ Consult your manager or dealer.
"Voice Msg Full" is displayed.	<ul style="list-style-type: none">• Delete the voice messages stored in the company and/or a personal message box. (☎ 2.6.1 Built-in Voice Message)

5.2 Feature Number List

5.2.1 Feature Number List

Numbers listed below are the default settings. There are flexible feature numbers and fixed feature numbers. If you change the flexible feature numbers, fill in your assigned numbers in the list for future reference.

Note

FENOH: Floating Extension Number of Hunting Group

Feature	Default	Assigned no.	Additional digits
LCD language change (additional digits varies depending on the area.)	484		1-4
Calling the operator	0 61 62		
Automatic line access number/ARS	9		
Outside line number	8		1-4
Calling a pre-set party by going off-hook/ cancelling/storing	74		1/0/ 2+phone no.+#
Calling using the number stored at your extension Storing the numbers	6* 60		0-9 [0-9]+phone no.+#
Calling using the number stored in the system	*		000-499
Redialling the last phone number you dialled	#		
Reserving a busy line/Completing a call to a busy party on an ISDN line	6	Fixed	
Cancel the reserving of a busy line	46		
Cancelling the Completion of Calls to Busy Subscriber [CCBS]	713		
Sending a call waiting tone	2	Fixed	
Leaving a message waiting indication/cancelling/ calling back/clearing a received indication	70		1+ext. no./0+ext. no./ 2/0+your ext.no.
Joining an existing call	3	Fixed	
Accessing the ISDN Key Pad Protocol service	729	Fixed	
Picking up a call for someone else — outside call — group — direct	4* 40 41		ext. no.
Holding or retrieving a call	50		

Feature	Default	Assigned no.	Additional digits
Retrieving from another extension — outside call — intercom call	53 51		1-7 ext. no.
Holding in a system parking zone or retrieving	52		0-9
Retrieving a call from a Telephone Answering Machine	728		
Using ISDN Call Hold	5*		
The extension Outgoing Message (OGM)/Timed Reminder OGM — recording — replaying — deleting	722 ↓		11/12 21/22 31/32
Setting the Built-in Voice Message function	710		[2-5]+725/0
Replaying/deleting all voice messages — replaying — deleting	723 724		
Leaving a voice message using the Direct Message function	725		ext. no.
Paging, or paging then transferring — all devices/all extensions/group — external speaker	63 64		* /0/1-8
Answering a paged announcement or an incoming call through the speaker	44		
Answering the paged announcement through telephones	43		
Receiving or refusing a call waiting tone or voice no tone/tone/OHCA/whisper OHCA	731		0/1/2/3
Accessing external services	66		

Feature	Default	Assigned no.	Additional digits
Forwarding your call — All Calls/Busy/No Answer/Busy, No Answer — To CO line, All Calls — To CO line, No Answer — cancelling (except "Follow Me" and "By ISDN Line") — Follow Me/cancelling — CFU/CFB/CFNR (By ISDN line) — cancelling All of "By ISDN Line"/CFU/CFB/CFNR — storing a pre-selected CLIP or DDI/MSN number — deleting a pre-selected CLIP or DDI/MSN number — confirming a pre-selected CLIP or DDI/MSN number — activating a pre-selected CLIP or DDI/MSN number — cancelling an activation of a pre-selected CLIP or DDI/MSN number	710 ↓ 718 ↓ 711 719 ↓		[2/3/4/5]+ ext. no. 6+line access no.+phone no.+# ×+line access no.+phone no.+# 0 [7/8]+your ext. no. [921/931/941]+your MSN+#+phone no.+# [90/920/930/940]+your MSN+# 1+[1/2]+[1-3]+CLIP/ DDI/MSN no.+# 0+([1/2]+[1-3])/0 [1/2]+[1-3] 1+([1/2]+[1-3])/0 0+([1/2]+[1-3])/0
Refusing all calls (DND) — forwarding to extension/operator/ no backup station — cancelling	710 ↓		1+[ext. no./0/×] 0
Forwarding calls from a hunting group/cancelling	714		1+forwarding FENOH+destination FENOH or ext.no./ 0+forwarding FENOH
Refusing direct outside calls (DND for Intelligent Call Handling 1:1 Call)/cancelling	56		1/0
Showing a message to the caller/cancelling	750		[1-9]+(parameter)/0
Joining the call hunting group/leaving	45		[1/0]+[FENOH or ×]
Conference	3	Fixed	
Calling with account codes	49		code+[# or 99]
Temporary tone dialling	*#	Fixed	
Dialling a DND extension	2	Fixed	
Setting the alarm/cancelling/viewing	76		1+time+ [0 (once)/1 (daily)]/ 0/2

Feature	Default	Assigned no.	Additional digits
Selects the pre-assigned CLIP/COLP number on the called/calling party's display — CLIP for group — COLP for group — CLIP for port — COLP for port	726 727 726* 727*		group no.+[1/2] group no.+[1/2] port no.+[0/1/2] port no.+[0/1/2]
Preventing your number being displayed on the called party's telephone/showing/changing the setting when making a particular call	57		2/0/1
Preventing your number being displayed on the calling party's telephone/showing	58		1/0
Denying other people the possibility of — seeing your call logs/Allowing — using your telephone/Allowing — picking up your calls/Allowing — paging through the speaker/Allowing — joining your conversation/Allowing	59 77 720 721 733		3 digit code twice/ stored code 3 digit code twice/ stored code 1/0 1/0 1/0
Day/Night service confirmation	#	Fixed	
Switching the display — day, month, time/day, month, year, day of the week	*	Fixed	
Paralleled telephones ring/do not ring	69		1/0
Switching the calling method (Ring/Voice)	*	Fixed	
Cancelling the feature settings	790		
Identifying malicious callers	737		
Changing the number of busy extension for Busy on Busy	717		
Calling the doorphone	68		1-3
Opening the door — from a specified phone — from any extension while talking to the doorphone	55 5	Fixed	1-3
Forwarding doorphone calls to outside parties — setting/cancelling — storing the phone number — clearing the phone number	716 715 ↓		[1-3/*]+[1/0] [0/1]+[1-3/*]+line access no.+phone no.+# [0/1]+[1-3/*]+#
Switching on an external relay	67		
Setting to use the second ringer/cancelling	730		1/0

Feature	Default	Assigned no.	Additional digits
Answering the second ringer	47		
*Assigning level of service — primary/secondary	79		[1/3]+ext. no.
Setting the Live Call Screening password/ cancelling	799		3 digit code twice/ stored code
Identifying Malicious Callers	737		
*Turning on/off the background music	65		
Switching the Day/Night service — automatic/to day/to night	78		0/1/2
*Recording/playing back/deleting an outgoing message	712		[1/2/3]+OGM no.
*Printing out the system working report/clearing	794		1/0

* Operator only

5.3 Directory

5.3.1 Directory

◆◆ *Extension*

Jack no.	Extension no.	Name	Jack no.	Extension no.	Name
1-1			4-1		
1-2			4-2		
2-1			5-1		
2-2			6-1		
3-1			7-1		
3-2			8-1		

 **System Speed Dialling**

Speed dial no.	Name	Phone no.	Speed dial no.	Name	Phone no.
000			046		
001			047		
002			048		
003			049		
004			050		
005			051		
006			052		
007			053		
008			054		
009			055		
010			056		
011			057		
012			058		
013			059		
014			060		
015			061		
016			062		
017			063		
018			064		
019			065		
020			066		
021			067		
022			068		
023			069		
024			070		
025			071		
026			072		
027			073		
028			074		
029			075		
030			076		
031			077		
032			078		
033			079		
034			080		
035			081		
036			082		
037			083		
038			084		
039			085		
040			086		
041			087		
042			088		
043			089		
044			090		
045			091		

Speed dial no.	Name	Phone no.	Speed dial no.	Name	Phone no.
092			138		
093			139		
094			140		
095			141		
096			142		
097			143		
098			144		
099			145		
100			146		
101			147		
102			148		
103			149		
104			150		
105			151		
106			152		
107			153		
108			154		
109			155		
110			156		
111			157		
112			158		
113			159		
114			160		
115			161		
116			162		
117			163		
118			164		
119			165		
120			166		
121			167		
122			168		
123			169		
124			170		
125			171		
126			172		
127			173		
128			174		
129			175		
130			176		
131			177		
132			178		
133			179		
134			180		
135			181		
136			182		
137			183		

Speed dial no.	Name	Phone no.	Speed dial no.	Name	Phone no.
184			230		
185			231		
186			232		
187			233		
188			234		
189			235		
190			236		
191			237		
192			238		
193			239		
194			240		
195			241		
196			242		
197			243		
198			244		
199			245		
200			246		
201			247		
202			248		
203			249		
204			250		
205			251		
206			252		
207			253		
208			254		
209			255		
210			256		
211			257		
212			258		
213			259		
214			260		
215			261		
216			262		
217			263		
218			264		
219			265		
220			266		
221			267		
222			268		
223			269		
224			270		
225			271		
226			272		
227			273		
228			274		
229			275		

Speed dial no.	Name	Phone no.	Speed dial no.	Name	Phone no.
276			322		
277			323		
278			324		
279			325		
280			326		
281			327		
282			328		
283			329		
284			330		
285			331		
286			332		
287			333		
288			334		
289			335		
290			336		
291			337		
292			338		
293			339		
294			340		
295			341		
296			342		
297			343		
298			344		
299			345		
300			346		
301			347		
302			348		
303			349		
304			350		
305			351		
306			352		
307			353		
308			354		
309			355		
310			356		
311			357		
312			358		
313			359		
314			360		
315			361		
316			362		
317			363		
318			364		
319			365		
320			366		
321			367		

Speed dial no.	Name	Phone no.	Speed dial no.	Name	Phone no.
368			414		
369			415		
370			416		
371			417		
372			418		
373			419		
374			420		
375			421		
376			422		
377			423		
378			424		
379			425		
380			426		
381			427		
382			428		
383			429		
384			430		
385			431		
386			432		
387			433		
388			434		
389			435		
390			436		
391			437		
392			438		
393			439		
394			440		
395			441		
396			442		
397			443		
398			444		
399			445		
400			446		
401			447		
402			448		
403			449		
404			450		
405			451		
406			452		
407			453		
408			454		
409			455		
410			456		
411			457		
412			458		
413			459		

Speed dial no.	Name	Phone no.
460		
461		
462		
463		
464		
465		
466		
467		
468		
469		
470		
471		
472		
473		
474		
475		
476		
477		
478		
479		
480		
481		
482		
483		
484		
485		
486		
487		
488		
489		
490		
491		
492		
493		
494		
495		
496		
497		
498		
499		

◆◆ **Station Speed Dialling**

No.	Name	No.	Name
0		5	
1		6	
2		7	
3		8	
4		9	

◆◆ Quick Dialling

no.	Feature no.	Quick dial no.	no.	Feature no.	Quick dial no.
01			41		
02			42		
03			43		
04			44		
05			45		
06			46		
07			47		
08			48		
09			49		
10			50		
11			51		
12			52		
13			53		
14			54		
15			55		
16			56		
17			57		
18			58		
19			59		
20			60		
21			61		
22			62		
23			63		
24			64		
25			65		
26			66		
27			67		
28			68		
29			69		
30			70		
31			71		
32			72		
33			73		
34			74		
35			75		
36			76		
37			77		
38			78		
39			79		
40			80		

5.4 What is This Tone?

5.4.1 What is This Tone?

While on-hook

Ring Tones

Tone 1

- Incoming call from an external party
- An outside call is held for more than a specified time (default: 60 seconds).



Tone 2

- Incoming call from an extension
- An intercom call is held for more than a specified time (default: 60 seconds).



Tone 3

- Incoming call from a doorphone
- The pre-set alarm time has arrived.



Tone 4

- A reserved outside line or extension became idle.
- A caller is leaving a message in your mailbox (Live Call Screening — Private mode).

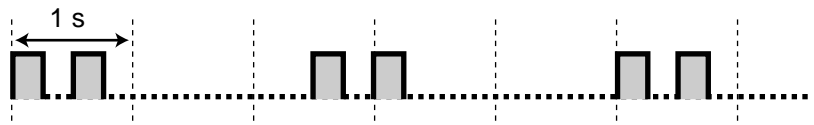

Tone 5

- Message Waiting tone for Single Line Telephone (SLT).



When going off-hook

Dial Tones

Tone 1

Normal

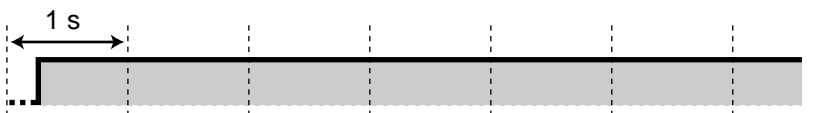

Tone 2

At least one feature has been changed from the default setting at your extension (except for the Doorphone Call Forwarding to CO Line feature).

**Tone 3**

- The alarm is being answered.
- Enter an account code to turn off the tone.

**Tone 4**

Message Waiting is on.

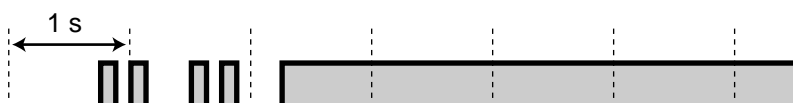
**Tone 5**

A Voice Message was received.

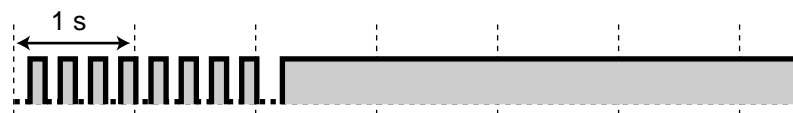
**Tone 6**

The rest of recording time becomes less than 5 minutes.

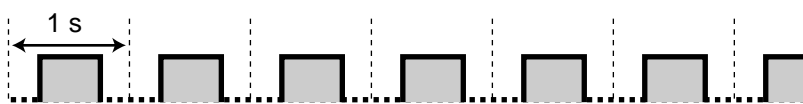
**When you make calls****Busy Tone****CCBS Tone**

- The called party on an ISDN line is busy

**Reorder Tone**

- The outside line you tried to seize is not assigned or denied.
- The wrong account code was entered.

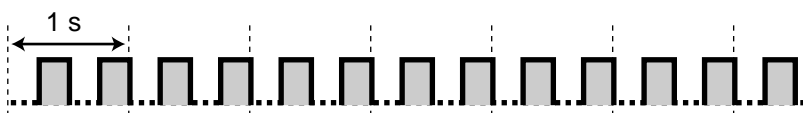
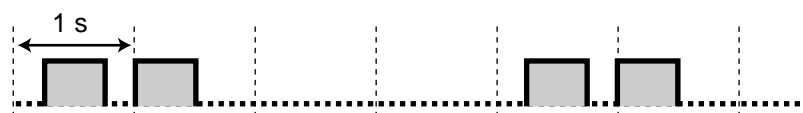
**Ringback Tone**

Do Not Disturb Tone

The dialled extension is denying incoming calls.



During a conversation

Indication Tones

Tone 1

Call waiting tone (default)

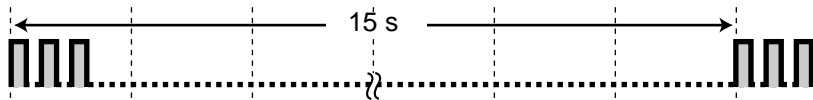

Tone 2

Call waiting tone from outside

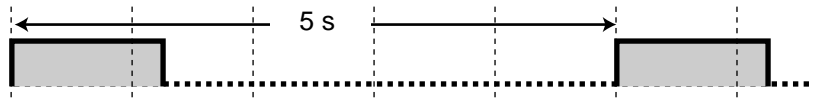

Tone 3

Call waiting tone from another extension

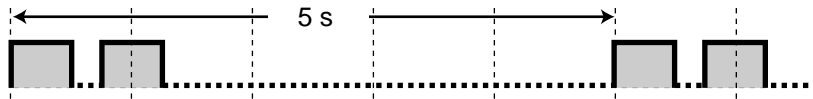

Tone 4

A call is held for more than a specified time (default: 60 seconds)

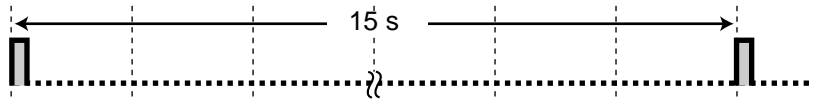

Tone 5

Call hold tone

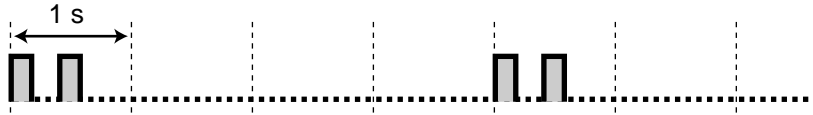

When setting the features programming

Confirmation Tones

Tone 1

- Set/cancel to deny other people the possibility of using your phone.
- The new setting differs from the previous setting by personal programming.
- Completing the system programming.



Tone 2

- The feature setting was completed successfully.
- Before paging through an external speaker
- The new setting is same as the previous setting by personal programming.

**Tone 3**

Before performing the following features:

- Retrieving a held call
- Picking up another call
- Paging/Answering a paged announcement
- Answering the call through a speaker

**Tone 4**

Establishing or leaving a three-party conversation

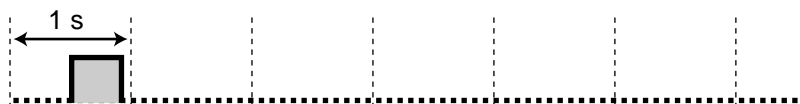
**Warning Tone**

- Your access to the voice message resource by using SOFT key is rejected.
- An invalid entry was made when you are programming and so on.



5.5 Specifications

5.5.1 Specifications

General Description

Item	Description		
System Capacity		Initial	Maximum Connections*
	Outside lines	2 ISDN (BRI) (1 ISDN CO + 1 ISDN CO/Extension, 4B Channel)	3 ISDN (BRI) (1 ISDN CO + 2 ISDN CO/Extension, 6B Channel) +1 Analogue CO line
	Extension lines	12 (4DPT+8SLT)	12 (4DPT+8SLT)
	DSS Console	4	4
	Doorphone	1 (KX-T30865)	3
	Door Opener	1	3
	External Relay	1	1
	External Pager	1	1
	External hold Music	1	1
	Second Ringer Relay	1	1
	RS-232C Port	1	1
Control Method	Stored Programme	MC68302 CPU 16 bit, 14.7 MHz	
	Control ROM	40 Mbit (Flash memory)	
	Control RAM	8 Mbit (SRAM)	
Switching	Non Blocking PCM Time Sharing Switch		
Power Supplies	Primary	110 V AC-240 V AC, 50 Hz/60 Hz	
	Secondary	Circuit Volt (+5 V, +26 V, -15 V)	
Internal Dialling	Pulse (10 pps, 20 pps), Tone (DTMF)		
Connector	ISDN (BRI) lines	RJ45 Modular Connector (8-pin)	
	Extension	Terminal Block	
	Doorphone	Terminal Block	
Extension Cable	Initial 2 Pair Wire (L, A, B, H) (Extension Port 1-4) 1 Pair Wire (A, B) (Extension Port 5-8)		
SMDR (Station Message Detail Recording) Interface	Interface	Serial Interface (RS-232C) (D-SUB, 9-pin)	
	Output Equipment	Printer	
	Detail Recording	Date, Time, Extension Number, Call Duration, Account Code	
Station Loop Limit	Digital Proprietary Telephone	40 Ω	
	Single Line Telephones KX-T7310/KX-T7315	600 including set	
	Doorphones	20 Ω	
Minimum Leakage Resistance	15,000 Ω		

Item	Description
Maximum Number of Station Instruments Per Line	1 for a digital proprietary telephone or a single line telephone. 2 for by parallel connection of a digital proprietary telephone and a single line telephone.
Ring Voltage	80 Vrms at 25 Hz depending on the Ringing Load
Primary Power	110 V AC-240 V AC, 50 Hz/60 Hz, 58 W (max.) (When power is off by the power switch: 1.2 W)
Backup Batteries	Total voltage: 24 V DC Maximum current: 2.3 A
Central Office Loop Limit	1,600 Ω max.
Environmental Requirements	0 °C-40 °C, 10 %-90 % relative humidity (no condensation)
Door Opener	60 V DC, 1 A (max.)/40 V AC, 1 A (max.)
Second Ringer Relay	60 V DC, 1 A (max.)/40 V AC, 1 A (max.)
External Relay	60 V DC, 1 A (max.)/40 V AC, 1 A (max.)

- * Install the KX-TD61280 for expansion of ISDN (BRI) CO lines, the KX-TD61281/KX-TD61283 for expansion of an analogue CO line and the KX-TD61260 for expansion of doorphones.
- * When an analogue CO expansion card is installed, the maximum connection of a doorphone or a door opener is 1 for each.

System Data

Item	Maximum Quantity
Operator	2
System Speed Dialling	500
Station Speed Dialling	10 per extension
Call Park Areas	10
Toll Restriction Classes	8
Extension Groups	8
Class of Service	8
Hunting Group	32

Section 6

Index

A

Absent Message Capability 118
Account Code Entry 49, 202, 206
Alternate Calling — Ring/Voice 51, 200
Answering, Direct CO Line 62
Automatic Callback Busy (Camp-On) 42
Automatic Overflow and Hurry-Up Transfer 189, 200
Automatic Route Selection (ARS) 2, 33

B

Background Music (BGM) 144
Background Music (BGM) — External 190
Built-in Voice Message 99
Busy on Busy 152
Busy Station Signalling (BSS) 44
Button, Direct Station Selection (DSS) 25, 31, 202, 203
Button, Flexible 202
Button, Loop-CO (L-CO) 25, 33, 200
Button, Single-CO (S-CO) 200
Buttons on Digital Proprietary Telephones 24

C

Call Deflection 69
Call Forwarding 108, 116, 202
Call Hold 72
Call Hold Retrieve 73
Call Hold, Exclusive 75
Call Log, Incoming 99, 167, 170, 188
Call Park 75
Call Pickup 65
Call Pickup Deny 142, 203
Call Retrieving, Telephone Answering Machine (TAM) 79
Call Splitting 81
Call Transfer 82
Call Waiting 85, 135, 200, 203
Calling Line Identification Restriction (CLIR) 140, 203
Calling/Connected Line Identification Presentation (CLIP/COLP) 137
Charge Fee Reference 206
Class of Service (COS) 186
Completion of Calls to Busy Subscriber (CCBS) 43
Conference 87, 202
Confirmation Tone 242
Connected Line Identification Restriction (COLR) 141, 203
Console 25, 194

D

Day/Night Service 145, 147, 203

DDI/CLIP Key 202, 217
Department code 206
Dial Tone 240
Direct Inward System Access (DISA) 55
Do Not Disturb (DND) 133, 202
Do Not Disturb (DND) for Intelligent Call Handling 1:1 Call 134, 203
Do Not Disturb (DND) Override 50
Door Opener 153
Doorphone Call 153
Doorphone Call Forwarding to CO Line 154, 203

E

Electronic Station Lockout 121
Emergency Call 33
Executive Busy Override 48
Executive Busy Override Deny 143, 203
Extension Group 65, 116, 123
External Feature Access 157
External Relay 165
EXtra Device Port (XDP) 17

F

Flexible Numbering 226
Full One-Touch Dialling 199

H

Handset/Headset Selection 200
Hands-free Answerback 64
Hands-free Operation 31
Hunting Group 116, 122, 152

I

Integrated Services Digital Network (ISDN)
Call Forwarding 97
Integrated Services Digital Network (ISDN)
Call Hold 92, 95
Integrated Services Digital Network (ISDN)
Call Transfer 92
Integrated Services Digital Network (ISDN)
Conference 95
Integrated Services Digital Network (ISDN)
Extension 30
Integrated Services Digital Network (ISDN)
Service Access 53
Intelligent Call Handling — Distribution of Incoming Outside Calls 216, 218
Intercom Calling 31
Internet Access 184

L

Line Access, Automatic 33
Line Access, CO Line Group 33
Line Access, Direct 32

Line Preference — Incoming (No Line/Prime Line/Ringing Line) 199
Line Preference — Outgoing (Idle Line/No Line/ Prime Line) 199
Live Call Screening (LCS) 160, 188, 200, 203
Log-In/Log-Out 122, 202

M

Malicious Call Identification (MCID) 151
Message Waiting 42, 45
Microphone Mute 90
Multilingual Selection 28
Mute 90

N

Notebook Function 89

O

Off-Hook Call Announcement (OHCA) 85, 135
Off-Hook Monitor 91
One-Touch Dialling 34, 199, 202, 203
One-Touch Transfer by DSS Button 83
Operator 185
Operator Call 32
Outgoing Message (OGM) 99, 100, 191

P

Paging — All 123, 136, 203
Paging — External 123, 136, 203
Paging — Group 123, 136, 203
Paralleled Telephone 148, 203
Phantom Extension 38
Pickup Dialling 37, 203
Predial 33
Pulse to Tone 52

Q

Quick Dialling 38, 239

R

Redial, Automatic 40, 174, 178
Redial, Last Number 40
Redial, Saved Number 41, 202
Remote Station Lock Control 188

S

Second Ringer 166
Special Display Features (Call Log, Outgoing) 174, 178
Special Display Features (Extension Dialling) 171
Special Display Features (Station Speed

Dialling) 171, 179
Special Display Features (System Feature Access Menu) 171
Special Display Features (System Speed Dialling) 171
Station Message Detail Recording (SMDR) 206
Station Programme Clear 150
Station Programming 199
Station Programming Data Default Set 201
Station Speed Dialling 34, 179, 238
System Speed Dialling 35, 216, 218, 232
System Working Report 195

T

Terminal Portability for ISDN Extension 80
Terminate 33, 203
Timed Reminder 99, 100, 131
Tone 51
Trunk Answer From Any Station (TAFAS) 67
Two-Way Recording into Voice Mailbox 162, 202

V

Voice Mail Integration 158, 202
Voice Mail Integration for Digital Proprietary Telephones 158

W

Whisper OHCA 85, 135



This Equipment complies with the essential requirements of the Directive 1999/5/EC Radio and telecommunications terminal equipment directive.

Copyright:

This manual is copyrighted by Kyushu Matsushita Electric Co., Ltd. (KME).
You may print out this manual solely for internal use with this model.
Except above, you may not reproduce this manual in any form, in whole or part,
without the prior written consent of KME.

© 2001 Kyushu Matsushita Electric Co., Ltd. All Rights Reserved.

Kyushu Matsushita Electric Co., Ltd.

1-62, 4-chome, Minoshima, Hakata-ku, Fukuoka 812-8531, Japan